

PDU48/300DUI Intelligent DCDCU

Power Subrack Installation & Commissioning Manual

To ensure the smooth operation, please read this manual carefully before installing and operating the PDU48/300DUI intelligent DCDCU power subrack (power subrack for short).

1 Appearance

There are five basic configurations of the power subrack. The appearances of PDU48/300DUI-S1, PDU48/300DUI-S2 and PDU48/300DUI-S3 are the same. Taking PDU48/300DUI-S1 power subrack as an example, the appearance of the power subrack is shown in Figure 1-1.

The appearances of PDU48/300DUI-S4 and PDU48/300DUI-S5 are the same, see Figure 1-2.

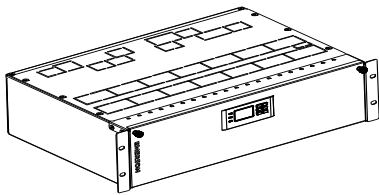

Figure 1-1 Appearance (1)

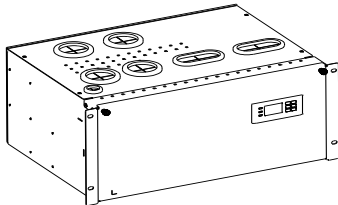

Figure 1-2 Appearance (2)

2 Technical Specification

Table 2-1 Technical specification

Parameter	Description
Operating temperature	-10°C ~ +55°C
Storage temperature	-40°C ~ +70°C
Relative humidity	5%RH ~ 95%RH
Altitude	≤ 2000m (derating is necessary above 2000m)
Others	No conductive dust or erosive gases. No possibility of explosion
Input voltage range	43.2Vac ~ 57.6Vac
DC output	PDU48/300DUI-S1/S2: LLVD (NPL): 63A × 5 BLVD (PL): 63A × 2 + 16A × 4 + 10A × 4 PDU48/300DUI-S3: LLVD (NPL): 32A × 12 + 16A × 1 BLVD (PL): 16A × 4 + 10A × 2 PDU48/300DUI-S4/S5: LLVD (NPL): 160A fuse × 2 + 63A + 32A BLVD (PL): 100A fuse × 2 + 16A × 2 Note: Only PDU48/300DUI-S4/S5 DC load is configured with 100A and 160A fuse, loads of the other power subracks are configured with MCBs
Output voltage	42.3Vdc ~ 57.6Vdc, nominal voltage: 48Vdc
Output current	PDU48/300DUI-S1/S2: BLVD current ≤150A, LLVD (NPL) current ≤150A PDU48/300DUI-S3: BLVD (PL) current ≤50A/user, LLVD (NPL) current ≤250A/ user (Note1) PDU48/300DUI-S4/S5: BLVD (PL) current ≤ 140A/user, LLVD (NPL) current ≤240A
Dimensions	PDU48/300DUI-S1/S2/S3: 485mm (W) × 270mm (D) × 133mm (H) PDU48/300DUI-S4/S5:

Parameter	Description
Dimensions	485mm (W) × 330mm (D) × 222mm (H)
Weight	About 10kg
Note1:	Standard configuration: PDU48/300DUI-S3 output current: BLVD (PL) current ≤50A/user, LLVD (NPL) current ≤250A/ user; PDU48/300DUI-S4/S5 output current: User 1, 2: BLVD (PL) current ≤60A/ user, LLVD (NPL) current ≤90A/ user, user 3: BLVD (PL) current ≤20A/ user, LLVD (NPL) current ≤60A/ user

3 Installation

3.1 Installation Preparation

Unpacking inspection

The power subrack should be unpacked and inspected after it arrives at the installation site. The inspection shall be done by representatives of both the user and Vertiv Tech Co., Ltd.

To inspect the power subrack, you should open the packing case, take out the packing list and check against the packing list that the power subrack is correct and complete. Make sure that the power subrack is delivered intact.

Cable preparation

The cable design should meet relevant industry standards. With cable length shorter than 30m, the Cross-Sectional Area (CSA) calculation should be based on the current density of 2.5A/mm². The suggested CSA is not less than 25mm².

The CSA of the power subrack grounding cable should be consistent with that of the maximum power distribution cable and not less than 6mm².

To select the load cable CSA, see Table 3-1.

Table 3-1 Selection of Load cable CSA

Load route rated current	Max. allowable current	Min. cable CSA	Max. cable length (voltage drop: 0.5V, with min. CSA)	Max. cable CSA	Max. cable length (voltage drop: 0.5V, with max. CSA)
160A	90A	25mm ²	3.5m	70mm ²	10.2m
100A	60A	16 mm ²	3.4m	70mm ²	15.3m
63A	35A	10mm ²	3.7m	25mm ²	9.1m
32A	18A	6mm ²	4.2m	25mm ²	17.8m
16A	9A	2.5mm ²	3.4m	25mm ²	35.6m
10A	5A	2.5mm ²	6.2m	25mm ²	64.1m

Note: The specs are applicable at ambient temperature of 25°C. If the temperature is higher than this, the CSA of the cable should be increased

3.2 Mechanical Installation

The installation modes of the power subrack include wall-mounted installation and rack installation.

Rack installation

Insert the power subrack to the rail, and use M6 screws to fasten the power subrack and the rail through the hangers. Refer to Figure 3-1 for installation of PDU48/300DUI-S1/S2/S3 series. Refer to Figure 3-2 for installation of PDU48/300DUI-S4/S5 series.

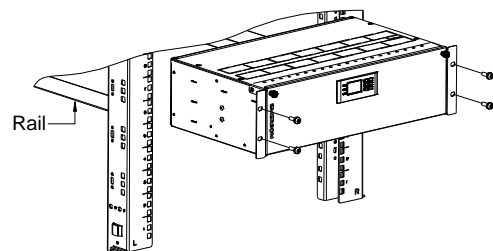

Figure 3-1 Rack installation (1)

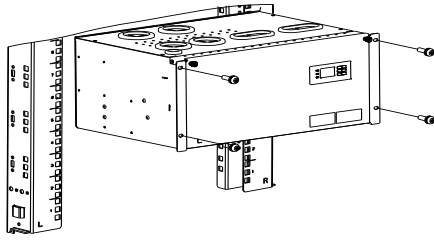

Figure 3-2 Rack installation (2)

Wall-mounted installation

Two wall-mounted methods are available for the subrack: horizontal and vertical.

1. Mark the specific installation position of the power subrack.

Two fixed supports of the power subrack are used to fix the power subrack onto the wall. The installation hole dimensions of the two wall-mounted methods are shown in Figure 3-3 and Figure 3-4 (unit: mm). Mark the exact central points of the installation holes according to the positions of the installation holes on the supports with a pencil or an oil pen.

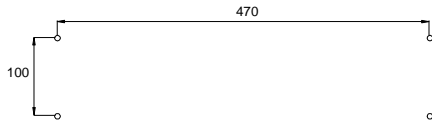

Figure 3-3 Dimensions of the installation holes (Horizontal)

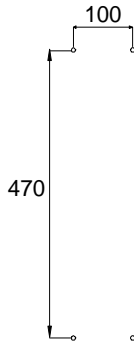

Figure 3-4 Dimensions of the installation holes (Vertical)

2. Dig the installation holes.

The required expansion bolt is M8. Take the $\phi 10$ aiguille to dig the installation holes at the marked points.

3. Install expansion bolts.

Clean the dust and put the expansion bolts into the installation holes. Hit the expansion bolts gently with a hammer to make the top at the same level with the wall.

4. Installation the power subrack.

Two wall-mounted methods are shown in Figure 3-5 and Figure 3-6.

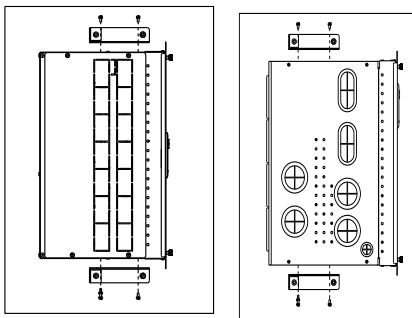

Figure 3-5 Method of wall-mounted (1)

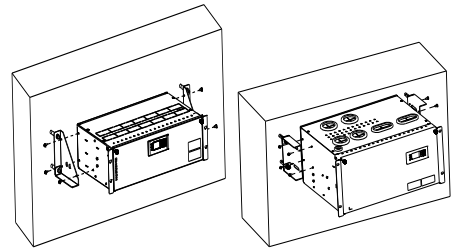
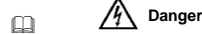

Figure 3-6 Method of wall-mounted (2)

Use the nuts with plain washer and spring washer to fix the power subrack onto the wall.

3.3 Electrical Connection



1. Switch off all MCBs before the electrical connection.
2. Only qualified personnel shall perform the cable connection.

Note

For some installations, because of space constraints, you should first connect the cables to the power subrack and then install the power subrack.

Connecting power cables

Refer to Figure 3-7, Figure 3-8, Figure 3-9, Figure 3-10 and Figure 3-11 for the connection terminals of PDU48/300DUI-S1, PDU48/300DUI-S2, PDU48/300DUI-S3, PDU48/300DUI-S4 and PDU48/300DUI-S5 respectively.

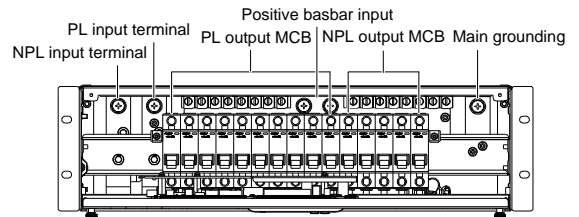

Figure 3-7 Connection terminals of the PDU48/300DUI-S1

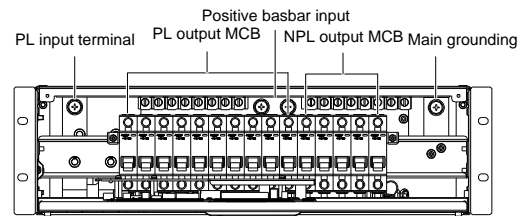

Figure 3-8 Connection terminals of the PDU48/300DUI-S2

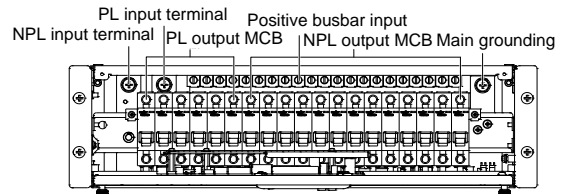

Figure 3-9 Connection terminals of the PDU48/300DUI-S3

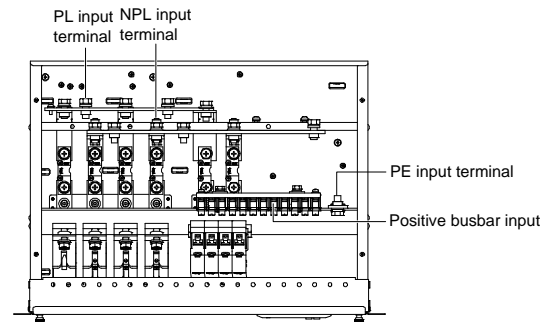

Figure 3-10 Connection terminals of the PDU48/300DUI-S4

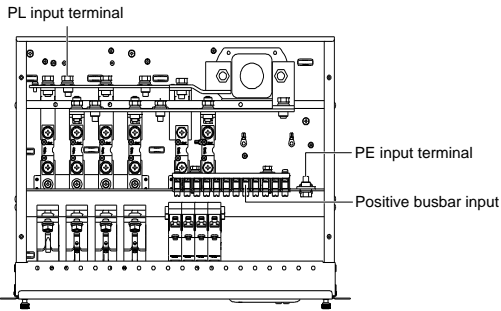

Figure 3-11 Connection terminals of the PDU48/300DUI-S5

Connect the power cables according to the descriptions listed in Table 3-2.

Note

Before connection, please use the side cutter plier to cut off the knock-off hole at corresponding position in the top cover according to you need.

Table 3-2 Description of the cable connections

Cable	Connection		
	From	To	
Grounding cable	Grounding terminal	Grounding copper bar of the machine room or ground	
DC input cable	DC output terminals of upstream power supply	Power subrack terminals	
DC output cable	Positive (+)	DC positive busbar	Positive terminal of the load
	Negative (-)	DC output MCB or Fuse	Negative terminal of the load

Connecting signal cables

After removing the monitoring board, you can see the signal interfaces, including one alarm dry contact interface and one RS485 communication interface, as shown in Figure 3-12. The functions of the signal interfaces are listed in Table 3-3.

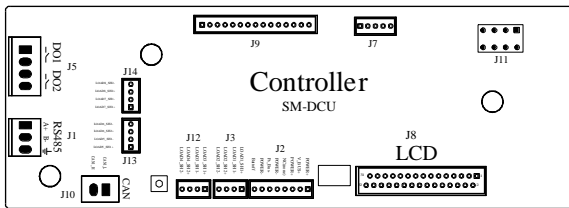

Figure 3-12 Signal interfaces

Table 3-3 Functions of the signal interfaces

Interface	Definition	Connection description
J1	RS232 interface	Connect the upstream computer
J5	Dry contact DO	Connect the signal cable, 1, 3 for NO, and 2, 4 for COM

The methods of the signal cables connection are as follows:

1. Connect the alarm dry contact cables (self-prepared): insert one end of the alarm dry contact cable to the corresponding port and the other end to the user's equipment.
2. Connect the RS485 communication cables (self-prepared): insert one end of the RS485 communication cable to the J1 port, and the other end to the user equipment.

Note

Under default status of the monitoring unit, when the system poses the above alarms, the corresponding status of the dry contact should be changed from Normally Open to Normally Closed. All the status changes of the DO must be confirmed by multimeter, and the DO will restore to its original status after the alarm is cleared. For DO1, major alarm by default; for DO2, observation alarm by default.

4 Testing

4.1 Installation Check And Power On

Before the test, inform the chief manufacturer representative. Only trained electrical engineer can test and operate this equipment. In

operation, the installation personnel are not allowed to wear conductive objects such as watches, bracelets, bangles and rings. During operation, note the hazardous voltage to avoid the severe or fatal physical injury and property damage. Before power-on, check the power subrack to ensure the proper earthing. Installation check must be done before testing. Then the batteries can be charged for the first time. Make sure that the MCBs of the upstream power supply are switched off, and that all the devices are properly installed.

Installation check

Item	OK	Remark
Check whether the input and output cable connection, and the power subrack grounding are correct and reliable	<input type="checkbox"/>	
Make sure that the communication cable and alarm cable are connected to the monitoring module. Check that the temperature sensor, if any, has been installed	<input type="checkbox"/>	

Startup preparations

Item	OK	Remark
Make sure that all the MCBs are switched off	<input type="checkbox"/>	

Startup

Item	OK	Remark
Switch on the output fuse or output MCB of the upstream power supply	<input type="checkbox"/>	
Check the power subrack voltage and busbar polarity with a voltmeter. The voltage difference between the measured value and displayed value should be less than $\pm 0.3V$	<input type="checkbox"/>	

4.2 Basic Setting

When the power subrack is put into service for the first time, the parameters of monitoring module must be set based on the actual power subrack configuration, only after that can the monitoring module display operation information and control the output.

Item	OK	Remark
Set the charge current limiting point based on the capacity of the fuse or MCB. Setting range: The default priority load of PDU48/300DUI-S1/S2 is 150A, and the non-priority load is 150A. The default priority load of PDU48/300DUI-S3 is 50A, and the non-priority load is 250A. For PDU48/300DUI-S4/S5, the default priority load of user 1 and user 2 is 60A, user 3 is 20A, and the non-priority load of user 1 and user 2 is 90A, user 3 is 60A. 50% ~ 70% of the nominal capacity setting is recommended	<input type="checkbox"/>	

4.3 Operation Status Check

The power subrack operation status check can be conducted through the monitoring module.

Item	OK	Remark
The difference between the displayed voltage on the monitoring module and actual value should be less than $\pm 0.3V$	<input type="checkbox"/>	

4.4 Final Steps

Item	OK	Remark
Make sure that materials irrelevant to the equipment have been all removed	<input type="checkbox"/>	
Check and hand over the spare parts that the user has purchased	<input type="checkbox"/>	
Note down all the operations taken, including time of the operation and name of the operator	<input type="checkbox"/>	

5 Alarm and Troubleshooting

Note

1. The maintenance must be conducted under the guidance of related safety regulations.
2. Only trained personnel with adequate knowledge about the power subrack shall maintain the inner parts.

The monitoring module alarms are classified in four types: major alarm, critical alarm, observation and no alarm. The handling methods of normal alarms are given in Table 5-1.

Table 5-1 Handling methods of alarms

Alarm	Handling method
DC Volt Low/High	1. Check the DC output voltage and value of 'Under' set through the monitoring module. If the set value is improper, correct it. 2. Check the DC output of the superior power is normal
Load Fuse Alarm/Batt Fuse Alarm	Check if the MCB of the route is switched off. If the MCB is open, find out the fault and remove it. Otherwise, the alarm loop is faulty, please contact Vertiv

Vertiv Tech Power Co., Ltd.

Address: Block B2, Nanshan I Park, No.1001 Xueyuan Road, Nanshan District, Shenzhen, 518055, P.R.China

Homepage: www.vertivco.com

E-mail: overseas.support@vertivco.com

Copyright © 2016 by Vertiv Tech Co., Ltd.

All rights reserved. The contents in this document are subject to change without notice.

Version: V1.4

Revision date: December 30, 2017

BOM: 31013363