



Liebert® ITA2™

30kVA User Manual

Copyright by Vertiv Co. Ltd.

The content in this document is subject to change without notice. All rights, including rights of translation, reproduced by printing, copying or similar methods, and even of parts, are reserved. Violators will be liable for damages. All rights, including rights deriving from patent license or registration of a utility model or design, are reserved. No part of this document may be reproduced or transmitted in any form or by any means without the prior written consent of Vertiv Co. Ltd.

Notice

The purchased products, services, and features are stipulated by the contract made between Vertiv Co., and the customer. All or part of the products, services, and features described in this document may not be within the purchasing scope or the usage scope. Unless otherwise specified in the contract, all statements, information, and recommendations in this document are provided "AS IS" without warranties, guarantees or representations of any kind, either express or implied. The information in this document is subject to change without notice. Every effort has been made in the preparation of this document to ensure the accuracy of the contents, but all statements, information, and recommendations in this document do not constitute a warranty of any kind, express or implied.

Vertiv Co., Ltd.

Website: www.vertiv.com.

- China

E-mail: vertivc.service@vertiv.com

Customer service hotline: 4008876510

- India

E-mail: customer.care@vertiv.com

Customer service hotline: 1800 209 6070

- Asia

Australia - au.service@vertiv.com

New Zealand - au.service@vertiv.com

Philippines - ph.service@vertiv.com

Singapore - sg.service@vertiv.com

Malaysia - my.service@vertiv.com

For Technical Support, users may contact the nearest Vertiv Co. local sales office or service center.

BOM: 31013769

Purpose of the Document



This document applies to the Liebert® ITA2 UPS which is the next generation series of UPS that provides continuous, high quality AC Power to business critical equipment.

This document explains the product description, installation measures, operational workflow, and thorough aspects from the user perspective. The figures used in this document are for reference only.

[Please read this manual carefully before installing, maintaining, and troubleshooting, especially the warning information in the manual](#)

Styling used in this Guide

The styles used in the manual will be defined as mentioned in the following table:

Situation	Description
<p><u>Warning/Danger/Caution</u></p> 	<p>The Warning/Danger/Caution note indicates a hazardous or potentially harmful situation that can result in death or injury. It also indicates instructions that need to be adhered to, failing which may result in danger and safety issues thereby having an adverse effect on the reliability of the device and security. Even for practices not related to physical injury, the content under the Warning heading is used for precautions which need to be taken which, otherwise, could result in equipment damage, performance degradation, or interruption in service.</p>
<p><u>Note</u></p> 	<p>The Note section indicates additional and useful information including tips and tweaks. It also calls attention to best practices and industry-best protocols that are standardized and help make maximum utilization of the resources at hand. Helpful information related to the mainstream stuff also comes under the Note heading helping the users get to grips with the definitions, concepts, and terminologies used in the manual.</p>

Version Information

Date	Revision	Change
11.01.19	V1.0	Initial release.
09.08.19	V1.1	Update some contents in Chapters 2, 3 and 8.
24.05.19	V1.2	Update Sections 5.2.4 and 5.3.

Special Declaration

Personnel Safety

1. This product must be installed and commissioned by professional engineers of the manufacturer or its authorized agent. Failure to observe this could result in product malfunction or personnel safety risk.
2. Take the time to read this product manual and the safety precaution thoroughly before installing and commissioning this product. Failure to observe this could result in product malfunction or personnel safety risk.
3. This product is not intended for life support equipment application.
4. Never dispose of the battery of this product in a fire, as it may explode and jeopardize personnel safety when exposed to flame.

Product Safety

1. If this product will be stored or remain de-energized for a long period, it must be placed in a dry and clean environment within specified temperature range.
2. This product should be used in an appropriate operating environment. For details, refer to the section on the environmental requirement in this manual.
3. This product is not designed for application in an environment:
 - Where the temperature and relative humidity are outside the specifications
 - Subject to vibrations or shocks
 - Where conductive dusts, corrosive gases, salts, or flammable gases are present
 - Near heat sources or strong electromagnetic interferences

Disclaimer

Vertiv disclaims any and all responsibility or liability for the defects or malfunction caused by:

- Application range or operating environment outside the specifications
- Unauthorized modification, improper installation or operation
- Force majeure
- Other actions not in compliance with the instructions in this manual

Safety Precautions

This manual contains the information concerning the installation and operation of Liebert® ITA2™ 30kVA UPS (hereinafter referred to as UPS). Please read this manual carefully prior to installation.

To reduce the chance of accident, please read the safety precautions very carefully before operation. The 'Caution, Note, Warning' in this user manual and on the product do not represent all the safety points to be observed, and are only supplement to various safety points. Therefore, the installation and operation personnel must receive strict training and master the correct operations and all the safety points before operation.

When operating Vertiv products, the operation personnel must observe the safety rules in the industry, the general safety points and special safety instructions provided by Vertiv.



- 1. The UPS must be installed, commissioned and serviced by engineers designated by the manufacturer or its agent. Failure to observe this could result in personnel safety risk, UPS malfunction and invalidation of warranty.*
- 2. The UPS has been designed for commercial and industrial use only, and is not recommended for use in life support applications.*
- 3. This is a Class C2 UPS product. In a residential environment, this product may nevertheless cause radio interference, in which case, the user is required to take additional measures to reduce the interference.*



Backfeed protection

Before operating the circuit, isolate the UPS firstly and then check the dangerous voltage between the ports, and that between the ports and earth.



Conformity and standards

The UPS complies with 2014/35/EU (LVD), 2014/30/EU (EMC), 2011/65/EU (RoHS) and the following product standards for UPS:

- IEC/EN 62040-1/AS 62040-1, General and safety requirements for UPS*
- IEC/EN 62040-2/AS 62040-2: Class C2 compliant*
- IEC/EN 62040-3/AS 62040-3 (VFI SS 111): Performance requirements and test methods*

The UPS installation should follow the above instructions and use the accessories specified by manufacturer.



When the UPS is operating, some parts have high voltage, therefore, contacting with them directly or through moist objects will result in fatal risk.



1. Before moving or rewiring the UPS, disconnect mains input power and the battery and make sure that the UPS is completely shut down. Otherwise, the output terminal may carry live voltage, presenting an electric shock hazard
2. Liquid or other irrelevant external objects are prohibited inside the UPS.
3. In case of a fire, a dry chemical fire extinguisher is essential. Using a foam fire extinguisher will cause electric shock.
4. The output neutral line of the UPS is from the input, after the neutral line is suspended by the upstream protection devices, the output neutral line will be unconnected.
5. To prevent the radio frequency of output cables from disturbing other electric equipment, it is recommended to use the UPS output cable with the length less than 10m.



High leakage current

1. Earth connection is essential before connecting the input power (AC mains and battery included).
2. Earth leakage current ranges from 3.5mA to 100mA.
3. Transient and steady-state earth leakage currents, which may occur when starting the equipment, should be taken into account when selecting instantaneous residual current circuit breaker (RCCB) or residual current detector (RCD).
4. Note that the earth leakage current of the load will be carried by RCCB or RCD.
5. This equipment must be earthed in accordance with the local electrical codes.



1. When selecting the UPS system upstream distribution protection equipment, ensure that it complies with the local electric regulations.
2. The specified upstream breakers are required to obtain the conditional short-circuit current rating, I_{cc} at 10kA symmetrical rms. The specified upstream breakers should comply with an IEC 60947 series standard.



User serviceable components

1. The UPS contains no user-serviceable parts. Do not remove the cover. Removing the cover may result in electric shock and will invalidate any implied warranty.
2. The UPS meets the safety requirements completely in operator access area. Only service personnel can contact with the hazardous voltage inside the UPS. However, the risk of contacting these voltages is minimized because the components with hazardous voltage may be contacted only by using a tool to remove the protective cover. No risk will exist if you follow the general norms and in accordance with the procedures recommended in this manual on equipment operation.



Battery high voltage

1. All the physical service and maintenance of the battery are performed by the trained technicians.

2. Operation on the battery will result in electric shock and high short-circuit current, therefore, before operating the battery, the following should be observed:

- Remove the watches, rings and other metal objects.
- Use the tools with insulation handle.
- Wear rubber glove and shoes.
- Avoid to place the tools and metal objects on the battery surface.
- Cut off the charge power supply before connecting or disconnecting the battery terminals.
- Check whether the battery is earthed accidentally, if yes, please disconnect the earthing. Contacting any earth battery parts will result in electric shock. Therefore, make sure that the battery is not earthed during installation and maintenance.

3. Battery manufacturers provide the details of the precautions to be observed when working on, or in the vicinity of the batteries. These precautions should be followed implicitly at all times. Attention should be paid to the recommendations concerning local environmental conditions and the provision of protective clothing, first aid and fire-fighting facilities.

The Manual Describes The Following Devices

Product	Model
30kVA	ITA-30k00AL3302P00 (Long back-up model)

Table of Contents

1 Product Introduction.....	1
1.1 Features.....	1
1.2 Model Configurations.....	2
1.3 Appearance And Components	2
1.3.1 Appearance.....	2
1.3.2 Components.....	3
1.4 Operating Principle.....	4
1.5 UPS State And Operation Mode.....	5
1.5.1 Normal Mode	5
1.5.2 Bypass Mode.....	6
1.5.3 Battery Mode	7
1.5.4 ECO Mode (For Single UPS With External Battery Only)	7
1.5.5 Fault State	8
1.5.6 Maintenance Bypass Mode (With an Optional POD)	8
1.6 Specifications	9
2 Single UPS Installation And Commissioning	11
2.1 Unpacking Inspection	11
2.2 UPS Moving	12
2.3 Installation Preparation	13
2.3.1 Location	13
2.3.2 Environmental Requirement	13
2.3.3 Installation Tools.....	15
2.4 External Protective Devices	16
2.4.1 Rectifier And Bypass Input.....	16
2.4.2 Battery Input	17
2.4.3 UPS Output	17
2.5 Mechanical Installation	17
2.5.1 Tower Installation.....	17
2.5.2 Rack Installation.....	18
2.6 Connecting Power Cables.....	21
2.6.1 Connecting I/O Cables	22
2.6.2 Connecting Battery Cables.....	24
2.7 Single UPS Commissioning	27
2.7.1 Check Before Start-Up	27
2.7.2 Start-up Interface	28

2.7.3 Normal Mode Start-Up	28
2.7.4 Battery Mode Start-Up	30
3 Parallel UPS Installation And Commissioning	31
3.1 Features	31
3.2 Requirements	31
3.3 Mechanical Installation	32
3.4 Connecting Power Cables	32
3.4.1 Connecting I/O Cables	33
3.4.2 Connecting Parallel Cables	34
3.4.3 Connecting Battery Cables	35
3.5 Commissioning Parallel System	38
3.5.1 Check Before Start-Up	38
3.5.2 Parallel System Parameters Setting	39
3.5.3 Power-On Commissioning For Parallel System	39
3.6 Installation And Commissioning For Dual Bus System	41
3.6.1 Introduction	41
3.6.2 Installing External Protective Device	42
3.6.3 Connecting Power Cables	42
3.6.4 Connecting LBS Cables	43
3.6.5 Setting Parameters Of LBS	43
4 Operation And Display Panel	45
4.1 Introduction	45
4.1.2 LED Indicators	46
4.1.3 Audible Alarm (Buzzer)	46
4.1.4 LCD And Functional Keys	46
4.1.5 Initial Start-up Guidance	47
4.2 LCD Menu Structure	49
4.3 LCD Screen Types	50
4.3.1 Start Screen	50
4.3.2 Flow Screen	50
4.3.3 Main Menu Screen	51
4.3.4 Submenu Screen	51
4.3.5 Default Screen	56
4.4 Prompt Window	57
4.5 UPS Alarm Message List	57

5 UPS Operation Instructions.....	62
5.1 UPS Start-Up.....	62
5.2 Transfer Procedures Between Operation Modes.....	62
5.2.1 Transfer From Normal Mode To Battery Mode.....	62
5.2.2 Transfer From Inverter Mode To Bypass Mode.....	63
5.2.3 Transfer From Bypass Mode To Inverter Mode.....	64
5.2.4 Transfer From Inverter Mode To Maintenance Bypass Mode.....	65
5.2.5 Transfer From Maintenance Bypass Mode To Inverter Mode.....	67
5.2.6 Adding A Single Unit In Parallel System.....	67
5.3 UPS Complete Shutdown.....	67
5.4 REPO.....	68
5.5 Auto Restart.....	68
5.6 Language Selection.....	69
5.7 Changing Current Date And Time.....	71
5.8 Setting Password.....	72
6 Communication.....	75
6.1 Installing Intelligent Card.....	75
6.1.1 Intelligent Card Port.....	75
6.1.2 Intelligent Card Option.....	75
6.2 Connection Cables For Dry Contact Port.....	77
6.3 Connecting USB Communication Cables.....	79
6.4 Connecting Serial Port Communication Cables.....	79
6.5 Connecting Control Port.....	79
6.6 Connecting Built-in Ethernet Port.....	80
7 Maintenance.....	81
7.1 Fan Maintenance.....	81
7.2 Battery Maintenance.....	81
7.3 Cleaning UPS.....	82
7.4 Checking UPS State.....	82
7.5 Checking UPS Functions.....	83
8 Options.....	84
8.1 Option List.....	84
8.2 POD.....	84
8.3 Communication Cables.....	86
8.4 Guide Rail.....	86
8.5 Dual Bus Parts.....	87

8.6 Communication Options And Temperature/Humidity Sensor	87
Appendix 1 LCD Parameters Setting	89
Appendix 2 Glossary.....	91
Appendix 3 Hazardous Substances And Content	92

1 Product Introduction

Liebert® ITA2™ 30kVA UPS (UPS for short) is an intelligent online UPS system with sine wave output developed by Vertiv. The UPS offers reliable and high quality AC power to the precision instrument.

The rack/tower installation can be used depending on your requirements. It is applicable to supplying AC power to small scale computer center, network, communication system, automatic control system and precision instrument.

This chapter introduces the features, model configurations, appearance and components, operating principle, UPS state and operation mode, and specifications of the UPS.

1.1 Features

The UPS features include:

- Output power factor is 1, which enhances the UPS load capacity
- On-line double conversion efficiency up to 96.5% and ECO efficiency up to 99%, which provide more efficient products for the customer
- Product volume decreased by 30% compared with the previous generation; little space occupied, simple handling and assembly
- 3U thickness. Tower installation and rack installation are optional to meet different installation requirements
- Capable of parallel connection to achieve up to 3 + 1 parallel redundant power
- High-frequency double conversion topology structure, with high input power factor, wide input voltage range, and output immune to grid interference, thus adaptable to areas with unstable mains supply
- Full digital control platform and hardware design platform, which can adapt worse unstable mains supply and load impact
- Support 32, 34, 36, 38, 40-block batteries; the long back-up model has a built-in large power charger with 13A charging capacity to provide fast charging
- Innovative design of the layout and the whole process greatly promote the reliability of the product; pass high temperature humidity durability experiment test of 1000 hours

- Operation and display panel with colorful LCD to help you learn about the UPS operation state and operating parameters. The LCD display will change according to the layout of the model
- Integrate Ethernet port, support HTTP protocol, and use the web browser to achieve the remote monitoring, no extra monitoring software required
- Capable of ECO power supply mode and smart sleep mode, which help you save energy to the maximum extent

1.2 Model Configurations

The model configurations are shown in Table 1-1.

Table 1-1 Model configurations

Model		Type	Description
30kVA	Long back-up model	ITA-30k00AL3302P00	For single UPS system, 1 + 1 parallel system and above, the external battery cabinet with large capacity is recommended

Model	Input	Output	Remark
30kVA	Three phase	Three phase	Common input configuration (default), split bypass configuration

1.3 Appearance And Components

1.3.1 Appearance

The UPS appearance is shown in Figure 1-1.



Figure 1-1 Appearance of UPS

1.3.2 Components

Front panel

As shown in Figure 1-2, the UPS front panel provides ventilation holes, operation and display panel, LED indicators and functional keys.



- | | |
|--------------------------------|--------------------|
| 1. Ventilation holes | 2. Functional keys |
| 3. Operation and display panel | 4. LED indicators |

Figure 1-2 UPS front panel

Rear panel

As shown in Figure 1-3, the UPS rear panel provides parallel/LBS ports, dry contact port, I/O terminal block, battery terminal block, Intellislot port, Ethernet port, USB port, RS232 port, REPO port and multi-function port. The SIC card in the Intellislot port is optional, purchase it if required.

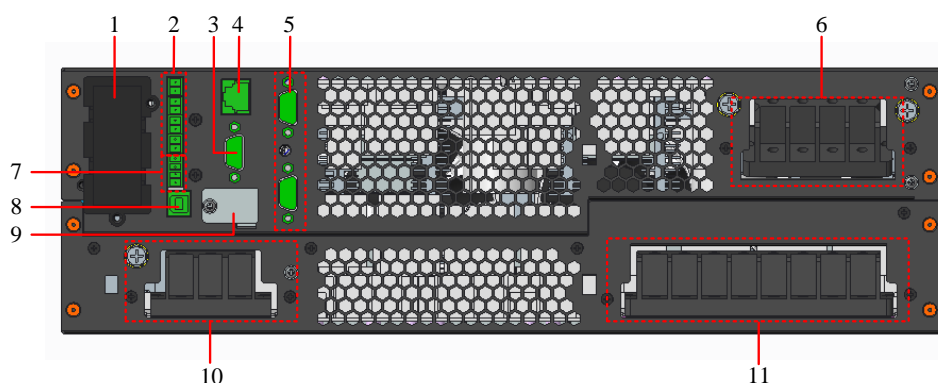

- | | | | |
|-----------------------|------------------------|-------------------|------------------|
| 1. Intellislot port | 2. Dry contact port | 3. RS232 port | 4. Ethernet port |
| 5. Parallel/LBS port | 6. AC output port | 7. REPO port | 8. USB port |
| 9. Multifunction port | 10. Battery input port | 11. AC input port | |

Figure 1-3 UPS rear panel



Non-authorized personnel are prohibited from opening the UPS chassis cover.

1.4 Operating Principle

The operating principle of the UPS is shown in Figure 1-4.

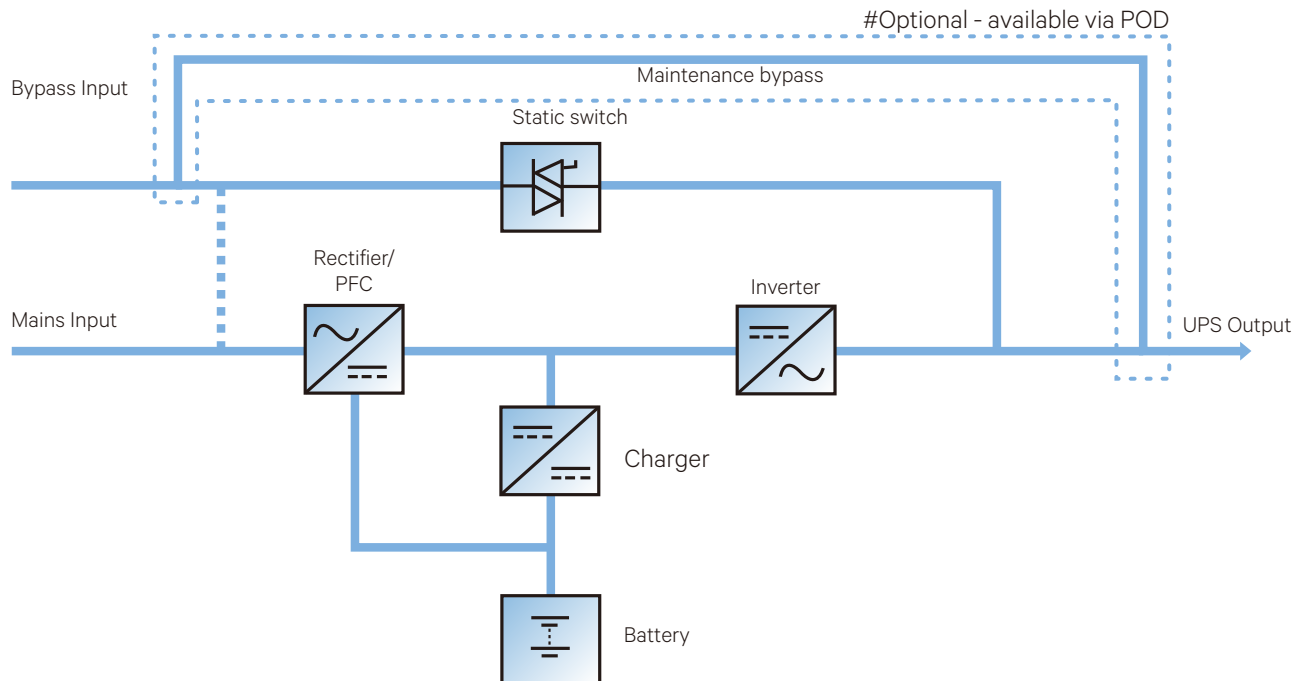

Figure 1-4 UPS operating principle

1. The UPS is composed of mains input (main and bypass), rectifier/PFC, charger, inverter, bypass, battery, DSP controller, and output.
2. When the mains is normal, the rectifier will start, and the charger will charge the battery string. Before turning on the UPS, the output voltage is bypass voltage, and the mains supplies power to the load through the bypass. After turning on the UPS, the electronic transfer switch connects the inverter output to the load, and the mains supplies DC power to the inverter through the rectifier/PFC circuit. The inverter then converts DC power into pure sine wave AC power, and supplies the AC power to the load through the electronic transfer switch.
3. When the mains is outside the UPS input supply tolerance levels, the battery supplies the required power to the load through the rectifier/PFC circuit where the battery voltage is boosted, and then supplies to the Inverter where it converts DC into pure sinewave AC power.
4. After the input mains returns within tolerance levels, the UPS will automatically transfer from Battery mode to Normal mode, the mains supplies DC power to the inverter through the rectifier/PFC circuit, and then the electronic transfer switch supplies AC power to the load.

1.5 UPS State And Operation Mode

For the LED indicators introduced in this section, refer to *4.1.1 LED Indicators*.

The UPS state and operation mode include: Normal mode, Bypass mode, Battery mode, ECO mode, Fault state and Maintenance Bypass mode. The operation schematic diagrams of Normal mode, Bypass mode, Battery mode and Maintenance Bypass mode are shown in Figure 1-5 to Figure 1-8.



Maintenance bypass mode is activated only when the UPS output power distribution unit (POD in short) is selected.

1.5.1 Normal Mode

When the mains input is normal, the load is supplied with voltage-stabilizing and frequency-stabilizing power by the mains after processing of the rectifier and the inverter, and meanwhile, the charger is charging the battery. The operation mode is Normal mode.

In Normal mode, the run indicator (green) is on, the alarm indicator is off, and the buzzer is silence.

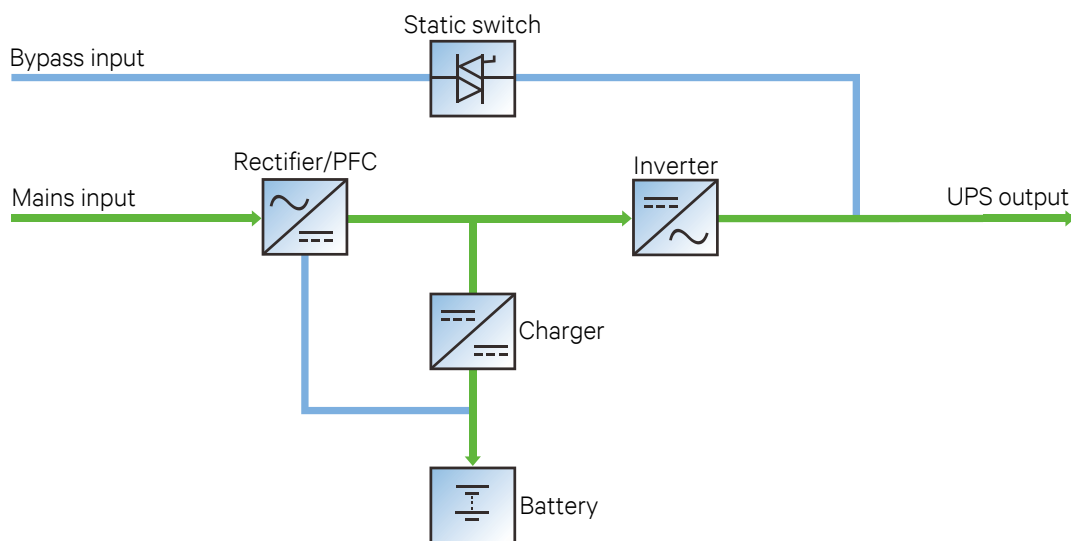

Figure 1-5 Normal mode

1.5.2 Bypass Mode

If the overload overtime, inverter or rectifier failure appears during the UPS operation in Normal mode, the UPS will transfer to Bypass mode, that is, the load is powered by the bypass source, which comes directly from the mains input. If the rectifier is normal, the internal charger will charge the battery.

In Bypass mode, the run indicator (green) is on, alarm indicator (yellow) is on, and the buzzer beeps every seconds. The 'Current' page in LCD will display 'On Bypass'.

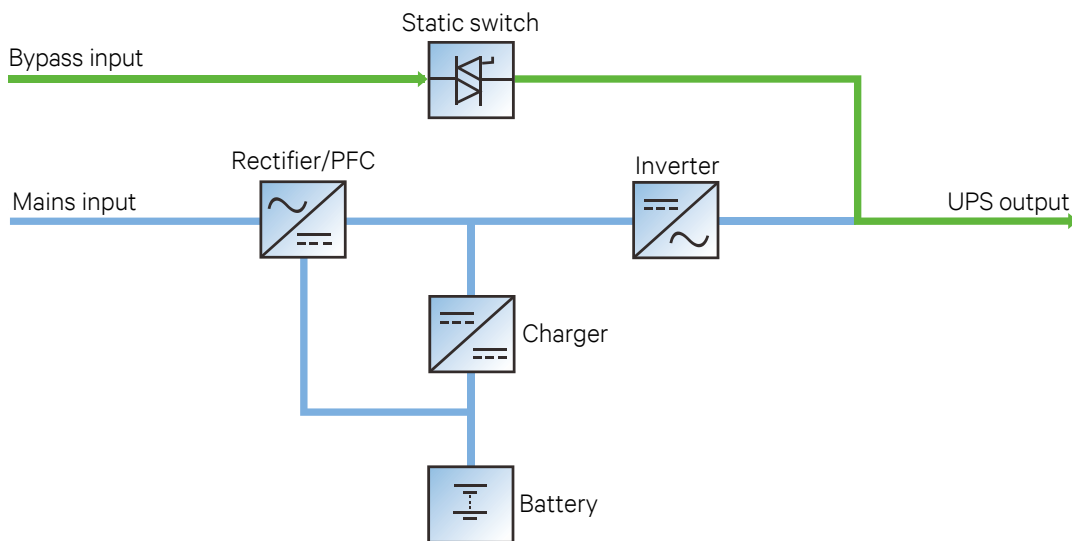

Figure 1-6 Bypass mode



In case of mains failure or mains voltage out of range in Bypass mode, the UPS will shut down and stop the output

1.5.3 Battery Mode

Upon mains failure or voltage out of range, the rectifier and internal charger will stop running, and the battery will supply power to the load through the inverter. In Battery mode, the run indicator (green) is on, alarm indicator (yellow) is on, and the buzzer beeps every seconds. The 'Current' page in LCD will display 'On Battery'.

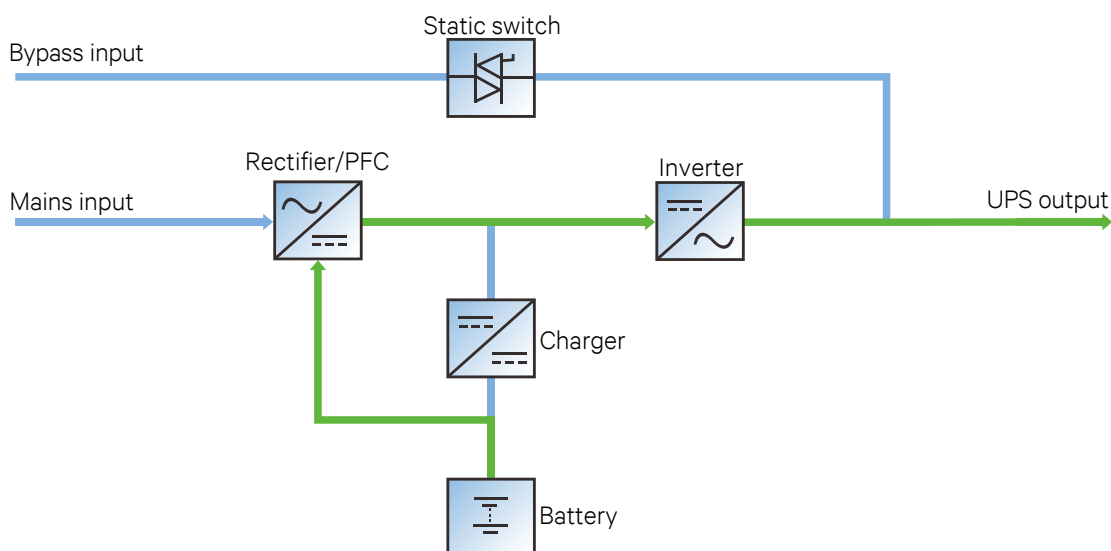

Figure 1-7 Battery mode



1. The battery has been fully charged before delivery. However, some loss of capacity is inevitable during transportation and storage. Therefore, it is important to charge the battery for eight hours before the UPS is first put into operation to ensure it can provide adequate backup time.

2. The Liebert ITA2 UPS supports cold start function, while this function is activated, UPS can be powered using battery mode without availability of input power supply. Therefore, the battery power can also be utilized independently for improving the system availability.

1.5.4 ECO Mode (For Single UPS With External Battery Only)

In ECO mode, the load is powered by bypass when the bypass voltage is normal, and the load is powered by inverter when the bypass voltage is abnormal. ECO mode is an energy-saving operation mode. For power equipment insensitive to power grid quality, you can use the ECO mode for power supply through bypass to reduce the power loss.



1. In ECO mode, if the bypass failure or abnormal bypass voltage appears when the output is not overloaded, the UPS will transfer to Normal mode. However, if the bypass failure or abnormal bypass voltage appears when the output is overloaded, the UPS will not transfer to Normal mode, but shut down the bypass.

2. In ECO mode, the efficiency of the UPS is up to 99%.

1.5.5 Fault State

In Normal mode, the UPS will transfer to Bypass mode if the inverter failure or UPS over-temperature appears. In Battery mode (with no bypass mains), the UPS will shut down and stop the output if the inverter failure or UPS over-temperature appears. In UPS Fault state, the alarm indicator (red) will be solid on, the buzzer will keep beeping, and the corresponding fault information will be displayed on LCD.

1.5.6 Maintenance Bypass Mode (With an Optional POD)

In case when UPS needs to be maintained/repaired online, Load can be transferred to the maintenance bypass using maintenance bypass MCB located on the front panel of the POD. The POD capacity must meet the requirements of total load demand.

Refer to *Liebert® ITA2™ 30kVA UPS Power Output Distribution Unit User Manual* for the detailed introductions.

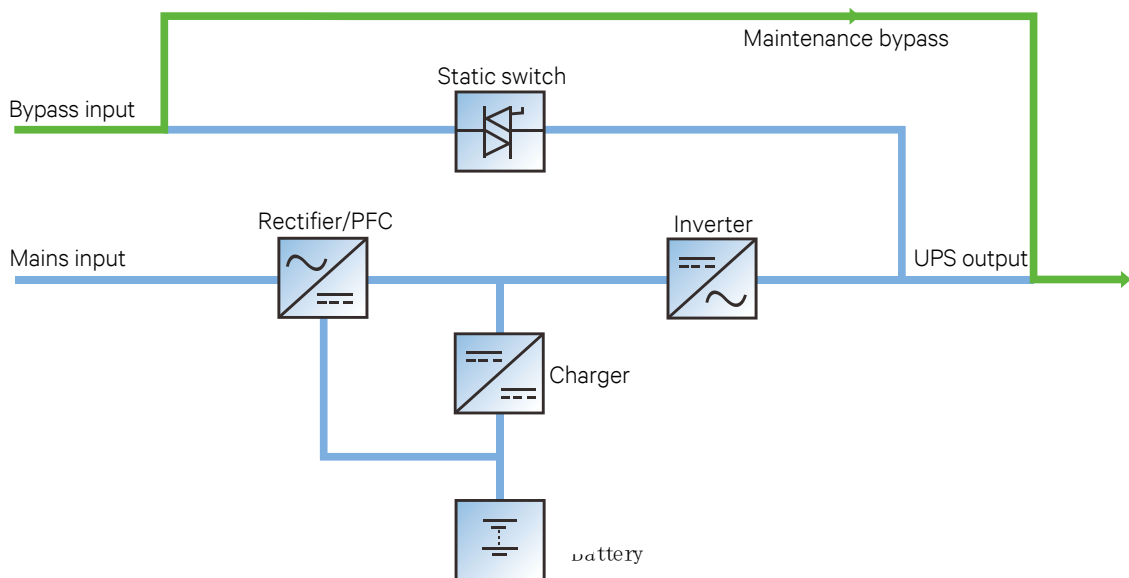

Figure 1-8 Maintenance bypass mode



In the event of UPS malfunctions or abnormal operation, contact your nearest Vertiv branch office or local service center. NEVER attempt to repair the UPS yourself, as this may result in injury to personnel and/or damage to equipment.

1.6 Specifications

The specifications are listed in Table 1-2.

Table 1-2 Specifications

Item		Specifications
		30kVA
Input	Rated voltage	380Vac/400Vac/415Vac (Line voltage)
	Voltage range	176Vac ~ 288Vac, at full load 100Vac ~ 176Vac, linear derating 100Vac, at half load
	Rated frequency	50Hz/60Hz
	Frequency range	40Hz ~ 70Hz
	Power factor	≥0.99, at full load; ≥0.98, at half load
Bypass	Rated voltage	380Vac/400Vac/415Vac (Line voltage)
	Rated frequency	50Hz/60Hz
	Overload capacity	At 25°C: 105% ~ 125%, 10min; 125% ~ 150%, 1min; 150%, 200ms
	Bypass voltage	Upper limit: +10%, +15% or +20%; default: +20% Lower limit: -10%, -20%, -30% or -40%; default: -40%
	Bypass frequency range	±5Hz, ±10Hz
Output	Rated power	30kW
	Voltage	380Vac/400Vac/415Vac (three phase output)
	Frequency synchronization range	Rated frequency±3Hz. Configurable range: ±0.5Hz ~ ±5Hz
	Frequency track rate	0.5Hz/s. Configurable range: 0.2/0.5/1Hz/s (single UPS), 0.2Hz/s (parallel system)
	Rated power factor	1
	Crest factor	3:1
	Voltage harmonic distortion	< 2% (linear load); < 4% (non-linear load)
	Dynamic response recovery time	40ms
	Overload capacity	At 25°C: 105% ~ 125%, 10min; 125% ~ 150%, 1min; 150%, 200ms
	Mains efficiency	up to 96.5%
Battery	Type	Sealed, lead-acid, maintenance-free battery
	Cell No.	32, 34, 36, 38, 40; 32 by default
	Rated voltage	384Vdc ~ 480Vdc
	Charge current	≤ 13A
Transfer time	Mains ↔ Battery	0ms
	Inverter ↔ Bypass	Synchronous transfer: ≤0ms Asynchronous transfer (default): ≤20ms Or 40ms, 60ms, 80ms, 100ms and 200ms are available
Noise		< 60dB
Panel display mode		Colorful LCD
Safety		IEC/EN62040-1
EMC	Conduction emission	IEC/EN62040-2
	Harmonic current	IEC/EN61000-3-12

Item		Specifications
		30kVA
Surge protection		IEC/EN-61000-4-5, endurance level X (6kV) (live line to earth), level 4 (4kV) (during live lines); ANSI C62.41, 6kV/20hms
Protection level		IP20
Ambient condition	Operating temperature	0°C ~ 50°C (0~ 40°C no derating, 0.7 will be derated when above 50°C)
	Storage temperature	-40°C ~ +70°C (battery excluded); -25°C ~ +55°C (battery included)
	Relative humidity	5%RH ~ 95%RH, non-condensing
	Altitude	≤3000m; derating when higher than 3000m
Size	W*D*H (mm)	430*570*130
Weight	Net weight (kg)	23.5
	Gross weight (kg)	41

2 Single UPS Installation And Commissioning

This chapter introduces the installation, cable connection and commissioning of the single UPS.

Each site has its own peculiarity, so this chapter provides general installation procedures and methods for the installation engineer who should conduct the installation according to the actual conditions.



Professional installation

1. The UPS should be installed by a qualified engineer in accordance with the information provided in this section. In the event of any problems, contact your local Vertiv service center immediately.
2. The UPS must NOT be switched ON without the approval of the commissioning engineer.
3. For other equipment which is not introduced in this manual, the detailed information about mechanical installation and electrical installation are delivered with the equipment.



3-phase 5-line for power input

The UPS can be connected to 3-phase 5-line (A, B, C, N, PE) TN, TT and IT AC power distribution system (IEC60364-3).

2.1 Unpacking Inspection

The UPS adopts the wooden box. Unpacking steps are as follows:

1. Remove the side panels and top cover.

Use a hammer or straight screwdriver to straighten the connection hook that connects the side panels to the top cover, as shown in Figure 2-1.



Figure 2-1 Straightening the hook

2. Dismantle the cover plate of the cardboard box, and remove the UPS, as shown in Figure 2-2.

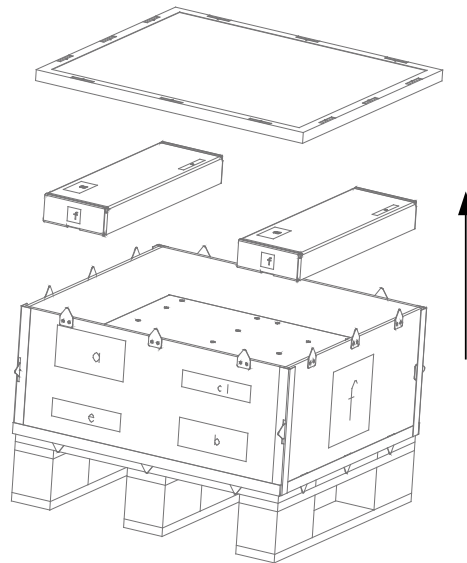

Figure 2-2 Unpacking cardboard box

Then you should check the following items:

1. Visually inspect the UPS appearance for transportation damage. If any problem is found, please notify the carrier immediately.
2. Check the accessories and models against the delivery list. If any problem is found, please notify the dealer immediately.

The battery appearance must be inspected before accepting and using the battery. If there exists any package damage, dirty battery terminal, terminal erosion, rust, or enclosure crack, deformation or liquid leakage, replace it with a new battery. Otherwise, battery capacity reduction, electric leakage or fire may be caused.

2.2 UPS Moving



It is prohibited to move the UPS through the brackets.

The UPS cabinet can be moved by human, or forklift or other similar lifting equipment.

The battery is very heavy. Please use proper method to move and lift the battery, so to prevent any damage to human being or the battery terminal. Severe damage to the battery may cause fire.

2.3 Installation Preparation

2.3.1 Location

To extend the UPS life, the chosen place must offer:

- Convenient wiring
- Adequate operator access area
- Good ventilation to meet the heat dissipation requirements
- No corrosive gas, such as sulfur dioxide and so on
- No excessive moisture or heat source
- No excessive dust
- Compliance with fire-fighting requirements
- Operating temperature compliant with the specifications, see Table 1-2 for details

2.3.2 Environmental Requirement

UPS room

The UPS is designed for indoor installation, which should be installed in a clean and well-ventilated environment, to keep the ambient temperature within the specifications.

The internal fans provide forced air cooling for the UPS. Cooling air enters the UPS through the ventilation holes on the front panel, and exhausts the hot air through the back ventilation holes. Therefore, do not obstruct the ventilation holes. Maintain at least 200mm clearances between the front, rear of the UPS and the wall or adjacent equipment (see Figure 2-3), to avoid obstructing the UPS ventilation and heat dissipation. Otherwise, the UPS internal temperature will rise, which will shorten the UPS life.

If necessary, an indoor exhaust fan should be installed to keep the indoor temperature from rising. An air filter should be used in a dusty environment where the UPS is to be operated.

Space reserved

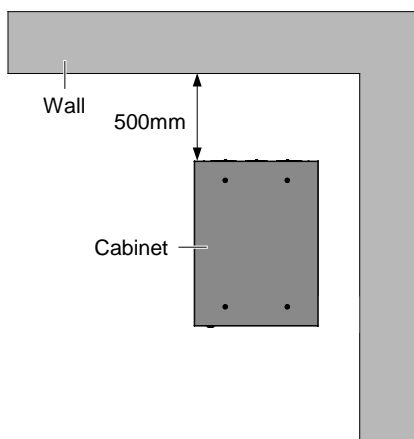

Figure 2-3 Installation clearances (top view of rack installation)



1. The UPS should only be installed on the concrete surface or other non-flammable surfaces.
2. As shown in Figure 2-3, the demonstration of the clearance between the rear panel of the cabinet and the wall is 500mm. The clearance should not be less than 200mm, it needs to be considered according to the actual situation for the sake of maintenance convenience.

Battery room

A small amount of hydrogen and oxygen will be generated at the end of battery charging, therefore, you must ensure that the fresh air ventilation of battery installation environment meets the EN50272-2001 requirements.

The battery ambient temperature should keep constant, for the ambient temperature is the main factor to affect the battery capacity and life. The battery standard operating temperature is 20°C, operation above this temperature will shorten the battery life, and operation below this temperature will reduce the battery capacity. If the battery average temperature in operation rises from 20°C to 30°C, the battery life will be reduced by 50%; if the battery temperature in operation exceeds 40°C, the battery life will be decreased exponentially. In normal situation, the allowable ambient temperature for the battery is between 15°C to 25°C. The battery should be kept away from heat source and air outlet.

When the UPS uses an external battery, you must install a battery protective device (such as fuse or circuit breaker) close to the battery, and use the shortest wiring distance for the connection between the protective device and the battery.

Storage environment

When the UPS does not need to be installed immediately, the UPS must be stored indoors to be protected from the excessive moisture or over-temperature environment. The battery requires dry and low temperature, well-ventilated environment for storage, and the most suitable storage temperature is 20°C ~ 25°C.



Battery hazards

During the battery storage, the battery must be periodically charged according to the battery instructions. When charging the battery, you can connect the UPS to the mains temporarily to charge and activate the battery.

















2.3.3 Installation Tools









1. For the sake of safety, the installation tools under live operation must be insulated.

2. Tools in Table 2-1 are for reference only; please follow the actual requirement for on-site installation and connection.

Table 2-1 Tools

Name	Drawing	Name	Drawing
Electric hand drill		Adjustable wrench	
Slotted screwdriver		Cross head screwdriver	
Stepladder		Forklift	
Drill		Wire cutting plier	
Claw hammer		Diagonal cutting plier	
Insulating shoes		Antistatic gloves	
Electrician knife		Cable tie	
Insulating tape		Insulating gloves	

Name	Drawing	Name	Drawing
Crimping plier		Heat shrinkable tube	
Insulated torque wrench		Torque screwdriver	
Multimeter		Clip-on ammeter	

2.4 External Protective Devices

The circuit breaker or other protective devices must be installed at the external AC input end of the UPS. This section provides the general guidance for qualified installation engineer. The qualified installation engineer should learn about the local wiring regulations and other related information.

2.4.1 Rectifier And Bypass Input

Overcurrent

The appropriate over-current protective device should be installed on the mains input power distribution, and the current capacity of power cable and the system overload requirements should be taken into account in installation (see Table 2-2). For the thermomagnetic circuit breaker, see Table 2-4.

Split-bypass

When the system uses split-bypass, separate protective devices should be installed for the mains and bypass at the mains input power distribution.

Main/Bypass backfeed protection

The UPS has main/bypass back-feed protection function.



1. The same neutral line must be used for the rectifier and bypass input power.
2. For IT power grid system, the 4-pole protective device for 3-phase UPS must be installed at the UPS external I/O power distribution.

Earth leakage current



The earth leakage current fed by the RFI filter in the UPS, ranges from 3.5-100 mA. Since earth leakage current is high which can cause false tripping of the circuit breaker. Therefore, we do not recommend to use the MCB with leakage current protection at upstream.

2.4.2 Battery Input

To facilitate the UPS installation, the battery is generally installed on the specially designed battery rack or in the battery room. The external battery cabinet should provide DC compatible circuit breaker to provide the over-current protection for the UPS and its batteries, the protective device specification is shown in Table 2-4. This circuit breaker shall be located as close as possible to the battery connecting terminal, and the wiring distance of the power and signal cables connected to the UPS shall be minimized.

2.4.3 UPS Output

The protective device must be installed for the UPS output power distribution. The protective device specification is shown in Table 2-4.

2.5 Mechanical Installation

Two installation modes are available: tower installation and rack installation. You can select an appropriate installation mode according to the actual conditions.

2.5.1 Tower Installation

1. Take out the support bases from the accessories, assemble a pair of support bases and a support base extension (accessory) together through the fastenings, as shown in Figure 2-4, and place them onto the flat installation table.

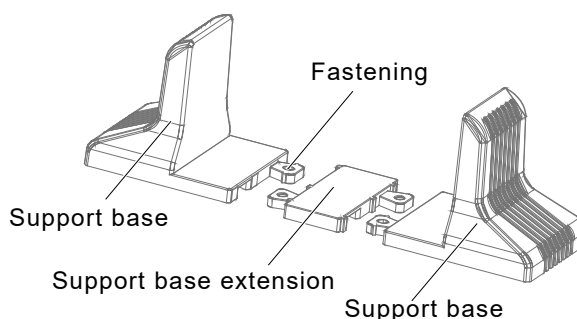

Figure 2-4 Connecting the support base with support base extension

2. Place the UPS on the support bases and support base extensions, as shown in Figure 2-5.

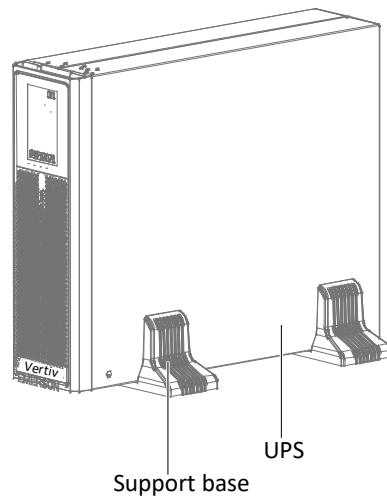

Figure 2-5 UPS Installation complete

2.5.2 Rack Installation

Installation procedures for UPS

1. Use eight M4 × 10 screws to fix two brackets (accessories) respectively on both sides of the UPS front panel, as shown in Figure 2-6.

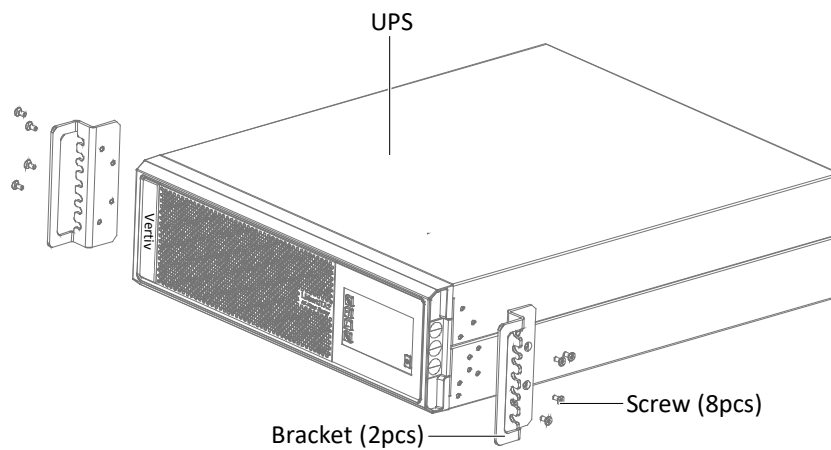

Figure 2-6 Installing brackets



It is prohibited to move the UPS through the brackets.

2. Install the guide rails.

You need to use guide rails when you select Liebert® ITA2™ series UPS & its options, and select the rack installation.

The installation procedures of the guide rails are as follows:

a) Take out the guide rails (one left guide rail and one right guide rail), guide rail screws and panel screws from the package, distinguish the left guide rail and right guide rail according to Figure 2-7, and confirm its retractable function respectively.

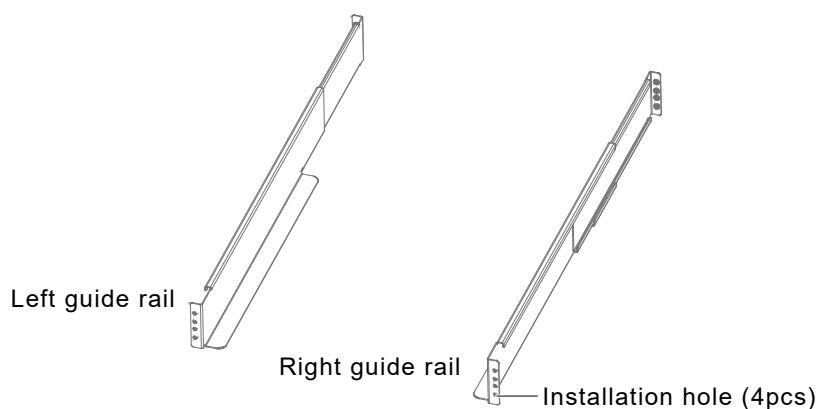

Figure 2-7 Appearance of the guide rail

The guide rail screw is shown in Figure 2-8.



Guide rail screw

Figure 2-8 Appearance of the guide rail screw

b) Adjust the length of the guide rail according to the dimensions of the rack.

c) Align the installation holes of the guide rail with the square holes of the rack, fix the guide rail onto the rack through the guide rail screws (totally eight), each left guide rail and right guide rail need four guide rail screws, as shown in Figure 2-9.

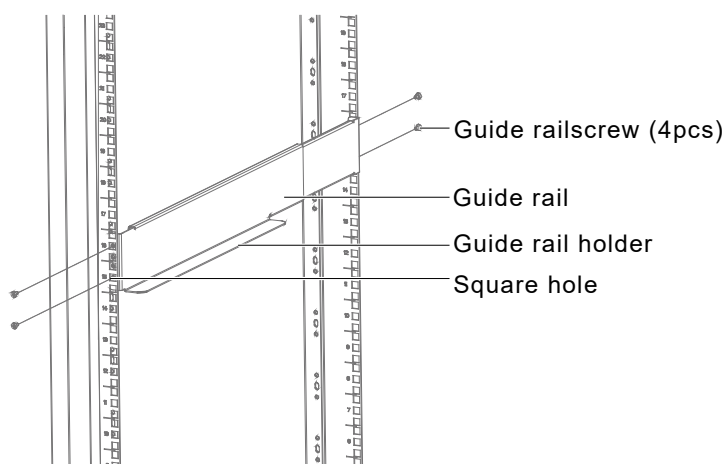

Figure 2-9 Installing the guide rail



1. The guide rail holder must be close to the front of the rack.
2. Any end of one guide rail has four installation holes (see Figure 2-8), do not use the two installation holes in the middle when fixing the guide rail. It is recommended to use the top and bottom installation hole (from top to bottom, installation hole 1 and installation hole 4).

The guide rail installation is finished, as shown in Figure 2-10.

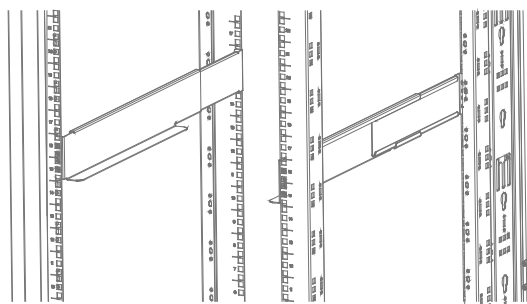

Figure 2-10 Guide rail installation completed

3. Place the UPS on the guide rails in the rack, and push it completely into the rack. Use four M6 × 16 screws to fix the UPS in the rack through the brackets, as shown in Figure 2-11.

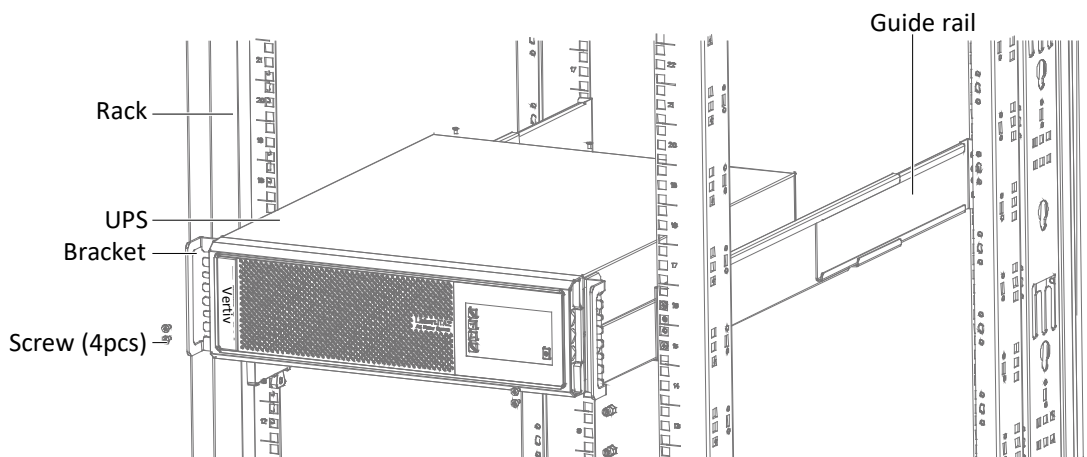

Figure 2-11 Installing the UPS

2.6 Connecting Power Cables

I/O cables and battery cables are required for connection. When connecting the cables, you should follow the local wiring regulations, take the environment situation into account, and refer to *Table 3B of IEC60950-1*.

The max. current in different operating modes is listed in Table 2-2, the recommended min. cable CSA is listed in Table 2-3. Select the appropriate cables according to Table 2-2 and Table 2-3.

Table 2-2 Max. steady state AC and DC current

UPS rated power (kVA)	Rated current (A)						Max. battery discharging current (A)
	Max. input phase current ^{1,2}			Max. output phase current ²			
	220V	230V	240V	220V	230V	240V	
30kVA	62	59	57	45	43	42	86



When the battery cables are selected, the maximum allowable voltage drop is 4Vdc according to the current value shown in this table. Do not ring the cables to avoid increasing the electromagnetic interference (EMI).

1: The input mains current of the rectifier and the bypass.

2: Non-linear load (switch mode power) affects the neutral cable design of the output and the bypass. The neutral cable current may exceed the rated phase current, up to 1.732 times as large as the rated current.

Table 2-3 Single UPS cable CSA (unit: mm², ambient temperature: 25°C)

Model	Input	Output	Bypass	Neutral cable	PE	Battery	Battery PE
30kVA	16	10	10	16	16	25	25

CSA (unit: mm ²)	Terminal type
4	OT4-6
6	OT6-6
10	RNBS8-6
16	RNBS14-6
25	RNBS22-6

The recommended I/O MCB capability of the UPS is listed in Table 2-4; select the MCBs according to your requirements.



The earth leakage current of the UPS can cause false tripping of the input Circuit breaker. Therefore, we do not recommend to use an MCB with leakage current protection at upstream of UPS.

The specified upstream breakers below are required to obtain the conditional short-circuit current rating, I_{cc} at 10kA symmetrical rms. The specified upstream breakers should comply with an IEC 60947 series standard.

Table 2-4 UPS I/O MCB selection

Model	Input interface	Recommended capability of input external MCB	Battery MCB	Output interface	Recommended capability of output external MCB
30kVA	Terminal block	80A/C (mains) 63A/C (bypass)	100A	Terminal block	63A/C



1. The 3-in 3-out bypass MCB is used to connect the bypass input upon split-bypass configuration. The main MCB can be used only upon common input configuration.
2. The battery CB should use the 250Vdc or above.

2.6.1 Connecting I/O Cables

The power cables of the UPS should be connected through the I/O terminal block located on the UPS rear panel. As shown in Figure 2-12.

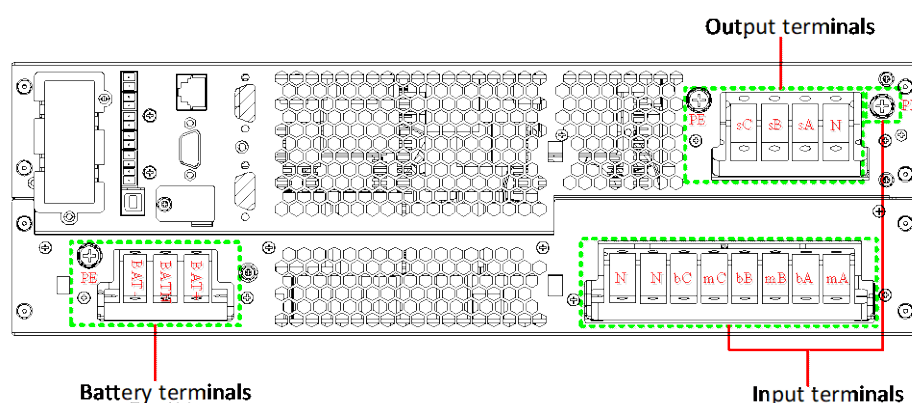

Output terminals - sA, sB, sC; Output PE terminal: PE; Common N:N.
 Input terminals - Mains input terminals: mA, mB, mC; Bypass input terminals: bA, bB, bC; Common N: N; Input PE terminal: PE.
 Battery terminals - BAT+, BAT N, BAT-; Battery PE terminal: PE.
 The shorting copper bar of the 3-in 3-out (common input) has been linked before delivery.

Figure 2-12 Terminals layout of the I/O terminal block



After the power cables connection, the protective cover board of the I/O terminal block must be reinstalled so as to avoid electric shock.

According to user's requirements, the I/O cable connections are divided into two types: 3-in 3-out, common input configuration (factory default), 3-in 3-out, split-bypass configuration.

Table 2-5 Shorting copper bar of 30kVA

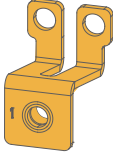
Bypass shorting copper bar	Drawing
1#: 2PIN copper bar	

The I/O cable connection procedures of the self-distribution for the two types are as follows:

3-in 3-out, common input configuration (factory default)

1. Three shorting copper bars (1#) are connected between the input & bypass terminals mA and bA, mB and bB, and mC and bC respectively before delivery.
2. Connect the mains input live wires (L1, L2, L3) to the three shorting copper bars 1# and connect input N line and input PE line respectively to the I/O terminal block (N and PE terminals) of the UPS.
3. Connect the standard output live wires (phase-A, phase-B and phase-C) respectively to the output terminals sA, sB and sC. Connect the output N line and output PE line respectively to the output terminals N and PE. As shown in Figure 2-13.
4. As shown in Figure 2-14, lead the battery positive cable, battery N cable and battery negative cable through the cable hole of the junction box, then respectively connect them to BAT+, BAT N, BAT- and PE, then fasten the fixing screws.

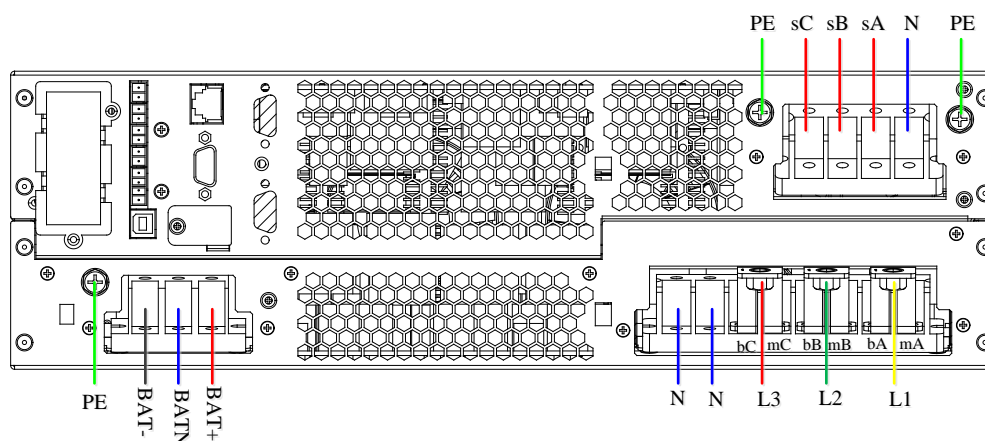

Figure 2-13 Wiring diagram (3-in 3-out, common input configuration)

3-in 3-out, split-bypass configuration

1. Remove the three shorting copper bars 1# installed before delivery.
2. Connect the input live wires (phase-A, phase-B and phase-C), input N line and input PE line respectively to the I/O terminal block (mA, mB, mC, N and PE terminals) of the UPS. Connect the bypass input live wires (phase-A, phase-B, phase-C and N) respectively to the input terminals bA, bB, bC and N.
3. Connect the standard output live wires (phase-A, phase-B and phase-C) respectively to the output terminals sA, sB and sC. Connect the output N line and output PE line respectively to the output terminals N and PE. As shown in Figure 2-14.
4. As shown in Figure 2-14, lead the battery positive cable, battery N cable and battery negative cable through the cable hole of the junction box, then respectively connect them to BAT+, BAT N, BAT- and PE, then fasten the fixing screws.

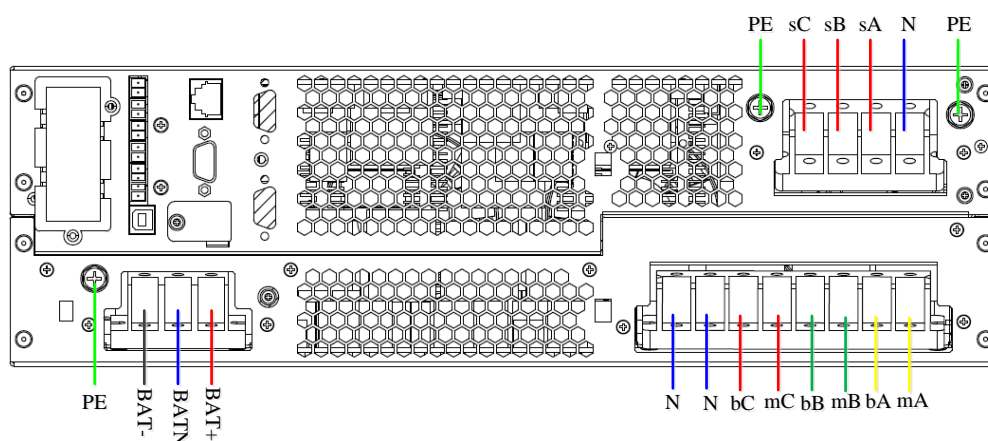

Figure 2-14 Wiring diagram (3-in 3-out, split-bypass configuration)



Before the commissioning engineer's arrival, if the load is not ready for accepting the power, please take good care of the safety insulation at the end of the output cable.

2.6.2 Connecting Battery Cables

Take special care when working with the batteries associated with the UPS. When all the blocks are connected together, the battery string voltage can be up to 432Vdc. This is potentially lethal. Please follow the precautions for high voltage operation. Only qualified personnel are allowed to install and maintain the battery. To ensure safety, the external batteries are to be installed inside a lockable cabinet or in a purpose-designed, dedicated battery room, so that they are only accessible to qualified service personnel.

1. All the battery cabinets or battery racks must be connected together and properly grounded.
2. When multiple batteries are used, they shall be connected in series and then in parallel. Before loading and power-up, it must be detected that the total voltage of the batteries is as

specified. The negative and positive poles of the batteries must be connected to the negative and positive battery terminals of the UPS according to the labels on the battery and UPS. If the battery is reversely connected, explosion and fire may be caused, it may result in battery and UPS damage or even human injury.

3. When connecting the cable between battery terminal and BCB, the BCB terminal shall be connected first.

4. The bending radius of the cable shall be larger than 10D, wherein D is the outer diameter of the cable.

5. When the battery cable is connected, it is prohibited to pull the battery cable or the cable terminal.

6. Do not cross the battery cables during the connection, and do not tie the battery cables together.



1. Before connecting the battery cables, confirm that the actual battery cell number and capacity are consistent with the parameter settings on the LCD menus. Incorrect settings can cause overcharging of the battery.

2. It is prohibited to reverse the polarity of the battery cables.

3. Before replacing the battery module and connecting the battery cables, disconnect the DC battery MCB, power off the UPS completely, and conduct isolation protection on the terminals.

4. It is recommended that the battery cable should not be longer than three meters. Otherwise, the UPS cannot operate normally.

Installing battery insulating plate

The battery terminals need insulating plates to guarantee the sufficient insulation distance between the battery external cables connection, then avoid the faults like arcing, short circuit occur.

Installation steps are as follows:

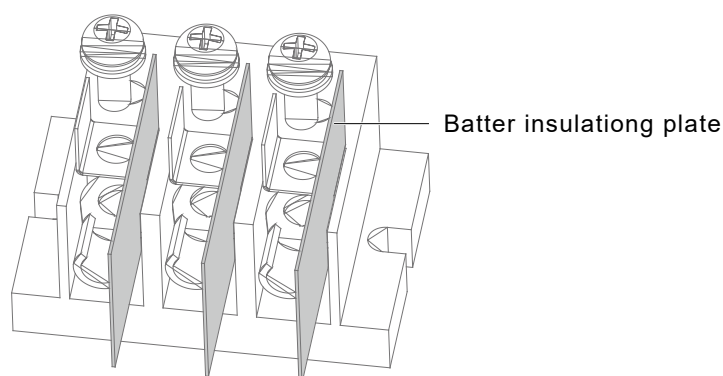

Figure 2-15 Installing battery insulating plates

1. First crimp the user external cable on the battery terminals, Figure 2-15 shows the OT terminals.

2. Crimp the battery insulating plates, and use the screws to fasten the OT terminals and insulating plates together onto the terminal block.



The installation sequence of the OT terminals and insulating plates must be strictly observed, otherwise the user external cables connection will be separated.

Installing battery

1. Before installation, you must inspect the appearance and accessories of the battery, and carefully read this manual and the user manual provided by the battery manufactory.
2. Maintain at least 10mm clearances between the front, rear, side panels of the battery and the wall or adjacent equipment to keep well-ventilated.
3. Maintain some clearances between the top of the battery and the upper baffle to facilitate monitoring and maintenance of the battery.
4. Install the batteries from the bottom to the top to prevent too high center of gravity. Place the battery well to avoid shake and impact.

Connecting external battery string

The default battery number of the UPS is 32-block (16-block for positive and 16-block for negative). The external battery string connection principle diagrams of the self-distribution are shown in Figure 2-16. The required battery backup time (i.e. the time for battery to supply load upon mains failure) is subject to the ampere-hour value of the battery. Sometimes, it is necessary to connect several strings of battery in parallel.

When several strings of battery are paralleled to increase the battery backup time, disconnecting device shall be equipped, so that the maintenance operation on a certain battery string will not affect the normal operation of other battery strings.



1. *As shown in Figure 2-16, one DC battery MCB must be added between the battery strings and the UPS.*
2. *The voltage of the battery string is DC high voltage, the capacity of the MCB and output cables is listed in Table 2-4.*
3. *The battery connecting terminal shall not be subject to any force, such as the pulling force or twisting force of the cable, otherwise, the internal connection of the battery may be damaged. Severe damage to the battery may cause fire.*
4. *The battery shall be firmly and reliably connected. After the connection is completed, the screw connections between all the terminals and the batteries shall be calibrated. The requirements on torque specified in the specifications or user manual provided by the battery manufacturer shall be satisfied. The connections between all the wiring terminals and the batteries shall be inspected and tightened at least once a year. Otherwise it may cause fire!*
5. *Batteries of different types, names or newness shall not be used together. Otherwise, the battery inconsistency will cause frequent over-discharge or under-charge of certain battery. At last, the battery will have premature failure, and the entire string of battery will have insufficient backup time.*

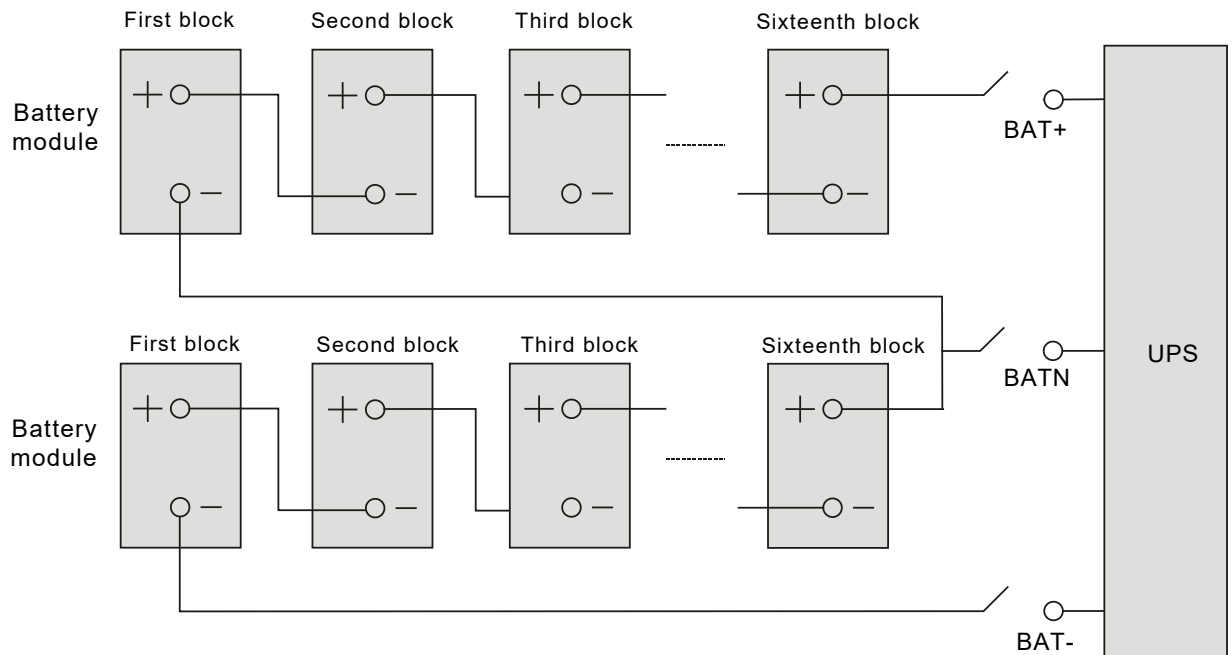

Figure 2-16 Battery string connection principle diagram

2.7 Single UPS Commissioning

2.7.1 Check Before Start-Up

1. Check and confirm that the power distribution mode of the UPS and the POD (if configured) is correct, that the connection of the power cables and signal cables is correct and there is no short circuit.
2. Check that the battery installation and the cable connection are correct, that the positive pole and the negative pole of the battery are correct.
3. Measure and confirm that the mains voltage and frequency are normal.
4. The output terminals of the UPS and the POD (if configured) are energized upon the startup. If the load is connected with the output terminals, make sure that the power to the load is safe.

2.7.2 Start-up Interface

If the system is first start-up, only mains input mode can be used, and the LCD screen will display the start-up interface, see Figure 2-17.

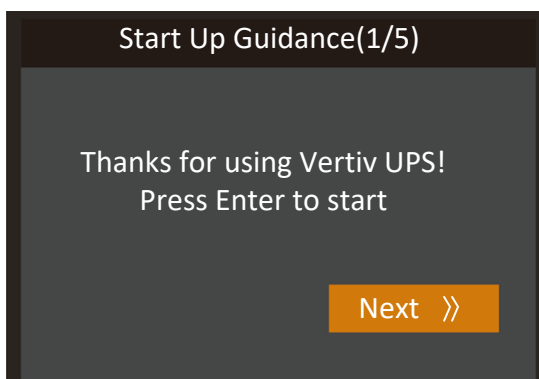

Figure 2-17 Start-up interface

2.7.3 Normal Mode Start-Up



1. Close the external output MCB and input MCB of the UPS one by one. If the single POD is selected to connect with the UPS, close the input MCB, bypass MCB and output MCB of the POD.



After closing the UPS external output MCB or the POD output MCB, the output terminal block of the UPS, output terminal block of the POD and power distribution end of the load will be live, pay attention to personal safety to avoid electric shock. Note whether it is safe to feed power to the load.

2. The rectifier runs in normal state for about 30 seconds, the start-up of the rectifier is finished.

3. Finish and check the parameter settings of the single UPS.

a) At main menu screen, press the  or  key to select 'Settings', and press the  key to enter the interface shown in Figure 2-18.

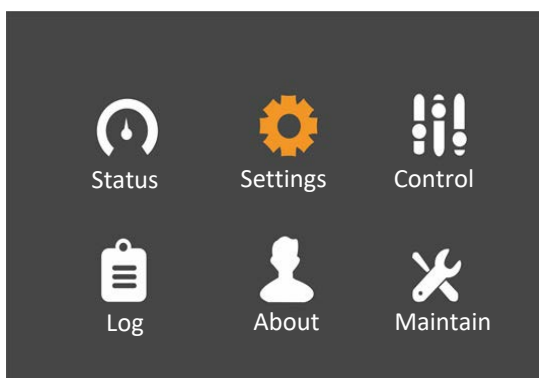



Figure 2-18 Main menu screen

b) Press the  or  key to select and set corresponding parameters (taking 'Output' as an example). As shown in Figure 2-19.

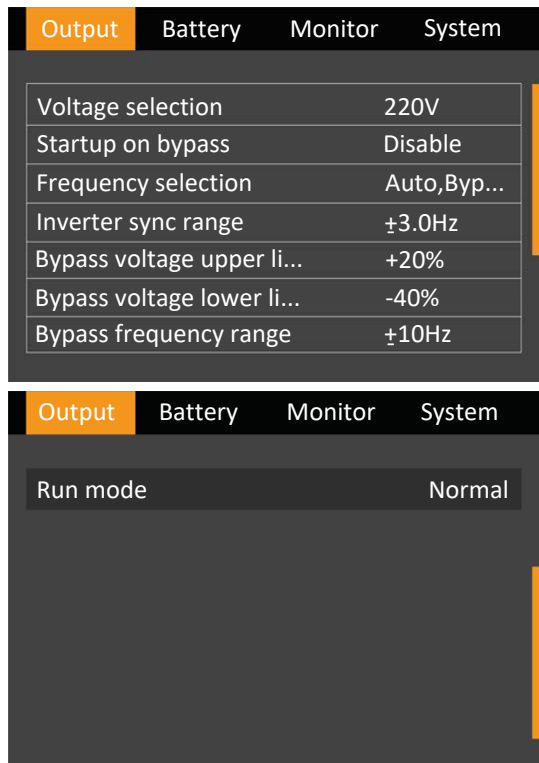

Figure 2-19 Output interface

4. After setting corresponding parameters, press the power button for two seconds, and the LCD prompts a dialogue box shown in Figure 2-20.

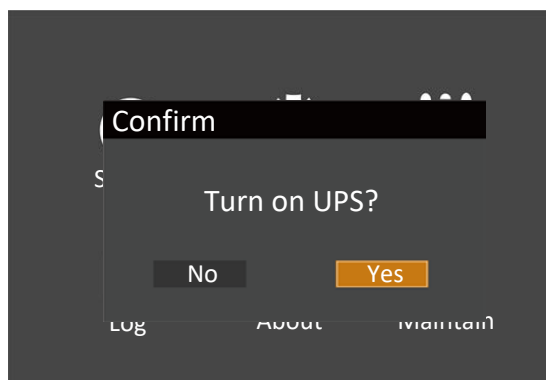

Figure 2-20 Turning on UPS

After selecting 'YES', the run indicator (green) blinks, the inverter starts, and the run indicator turns on.

5. Measure whether the inverter output voltage is normal.

6. If the battery is not connected, the alarm indicator is yellow. If the battery is connected, the alarm indicator turns off.

2.7.4 Battery Mode Start-Up

1. Close the battery MCB, and press the power button on the UPS front panel for two seconds, the LCD displays the startup screen. The alarm indicator will be yellow and the buzzer will continuously beep after the rectifier finishes the startup.
2. Press the power button for two seconds, the LCD prompts a dialogue box shown in Figure 2-21.

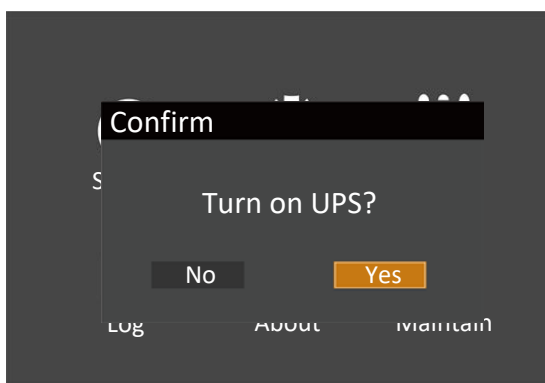

Figure 2-21 Turning on UPS

After selecting 'YES', the inverter starts, and the run indicator (green) is on.

3 Parallel UPS Installation And Commissioning

This chapter introduces the features, requirements, installation and commissioning of the parallel system.

The UPS parallel system provides the user with $N + X$ ($2 \leq N + X \leq 4$, $X=0$ or 1) parallel configuration, N stands for the basic parallel sets, X stands for the redundant sets.

1 + 1 parallel POD (optional) can provide safe and reliable power distribution function for the parallel system. The 1 + 1 parallel system only needs one 1 + 1 parallel POD; if N is not less than two, the external self-distribution will be required for the parallel system.

3.1 Features

1. The software and the hardware of each UPS in parallel system are the same as those of the single UPS. The basic parameters of the parallel system can be set through the LCD (Refer to *3.5.2 Parallel System Parameters Setting* for details), and the detailed parameters can be set through the background software (For service engineers only). For all UPSs of the parallel system, the requirements of the parameter settings are same.
2. The parallel cables form a ring connection (Refer to *3.4.2 Connecting Parallel Cables* for details) to provide reliability and redundancy for the system. The intelligent parallel logic provides the user with maximum flexibility. For example, each UPS in the parallel system can be switched off or on in random order; seamless transfer can be achieved between Normal mode and Bypass mode, and the transfer is automatically recoverable: that is, after the overload is removed, the system will return to the original operation mode automatically.
3. The total load of the parallel system can be queried through the LCD of each UPS.

3.2 Requirements

A UPS system composed of multiple parallel-connected UPSs is equivalent to a large UPS system. Nevertheless, it provides increased system reliability. To ensure equal utilization of all UPSs and compliance with relevant wiring regulations, the following requirements must be met:

1. All single UPSs must have the same capacity. The UPS must be connected to the same bypass source.
2. The bypass input power and the rectifier input power must be connected to the same neutral line input terminal.
3. If a residual current detector (RCD) is required, it must be set correctly and installed before the same neutral line input terminal, or it must monitor the protective earth current of the system. Refer to '*Warning: high leakage current*' of Safety Precautions before Contents.
4. The outputs of all single UPSs must be connected to the same output bus.

5. Since the UPS parallel system is not fitted with any auxiliary contact detection devices for the output MCB or the maintenance bypass MCB of the UPS, removing the single UPS from the parallel system before maintenance and adding the single UPS into the parallel system after maintenance must be conducted strictly following the procedures provided in 5.2 Transfer Procedures Between Operation Modes. Failure to observe this may affect the reliability of the load power supply.

3.3 Mechanical Installation

Taking the rack installation of the 1 + 1 parallel system, the mechanical installation method of the parallel system is as follows:

1. The installation method of 1 + 1 parallel UPS is the same as that of the single UPS. Refer to 2.5 *Mechanical Installation* for details.
2. As shown in Figure 3-1, the UPS should be installed at the bottom; and the 1 + 1 parallel POD should be installed on the top to facilitate the cable connection and operation. The installation method of 1 + 1 parallel POD is the same as that of the UPS.

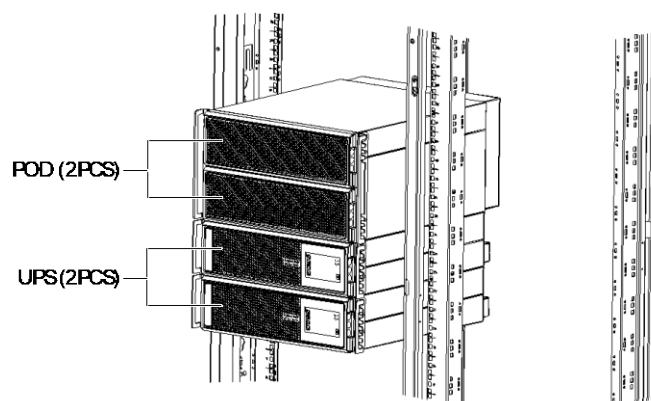

Figure 3-1 1 + 1 parallel system installation

3.4 Connecting Power Cables

Each single UPS of the parallel system needs to configure the MCB and cables respectively, refer to 2.6 *Connecting Power Cables* for the specification. The recommended configurations of the total power cables are listed in Table 3-1 to Table 3-4 for the parallel system.

Table 3-1 Input & output cable CSA for the 30kVA parallel system (unit: mm², ambient temperature: 25°C)

Parallel UPS number	3-in 3-out			
	Single input cable for parallel system	Single output cable for parallel system	Total neutral line for parallel system	Grounding cable for parallel system
2 units	50	50	50	50
3 units	95	95	95	95
4 units	120	120	120	120

3.4.1 Connecting I/O Cables

The power cables of the UPS are connected to the I/O terminal block of the rear panel of the UPS, the layout of the I/O terminal block is shown in 2.6.1 *Connecting I/O Cables*.

Power distribution mode

There are two modes for UPS parallel power distribution: using the 1 + 1 parallel POD (optional) provided by Vertiv, external isolation.

The power distribution mode of the parallel system is the same as that of the single unit, refer to 2.6.1 *Connecting I/O Cables*.

1. Using parallel POD power distribution

It is recommended to use 1 + 1 parallel POD power distribution mode if you need 1 + 1 parallel system, see 8.2 *POD* for details. For the installation and commissioning of different models, refer to *Liebert® ITA2™ 30kVA UPS Power Output Distribution Unit User Manual*.

2. External isolation for the parallel system

When the UPS number of the parallel system is more than two, use external isolation mode.

The block diagram of three UPSs parallel system is shown in Figure 3-2. Refer to *Power distribution mode in 2.6.1 Connecting I/O Cables* for the cable connection of each UPS. Refer to 2.6 *Connecting Power Cables* for the input and output MCB, the battery MCB and the cables when using the external isolation mode.

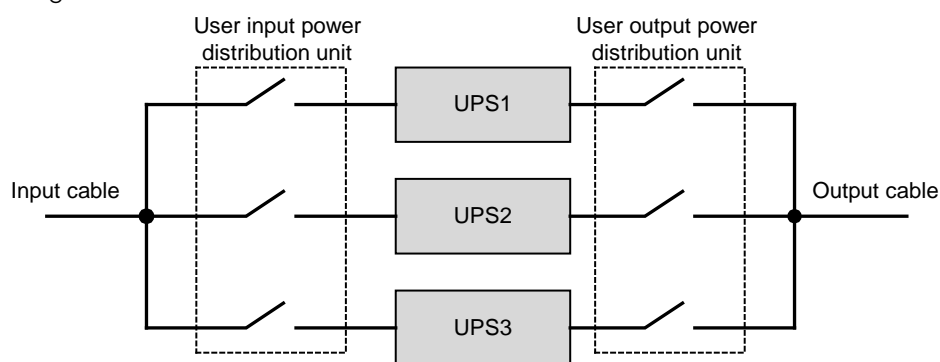

Figure 3-2 Block diagram of three UPSs parallel system



Configure each UPS with external input MCB and external output MCB when carrying out the power distribution for the parallel system, as shown in Figure 3-2.



After connecting power cables, the protective cover of the I/O terminal block must be reinstalled to avoid electric shock.

3.4.2 Connecting Parallel Cables

The parallel system provides parallel cable option. The parallel cables form a ring connection through the parallel ports on the rear panel of the UPS. The cable connection schematic diagram of 3 + 1 parallel system is shown in Figure 3-3.

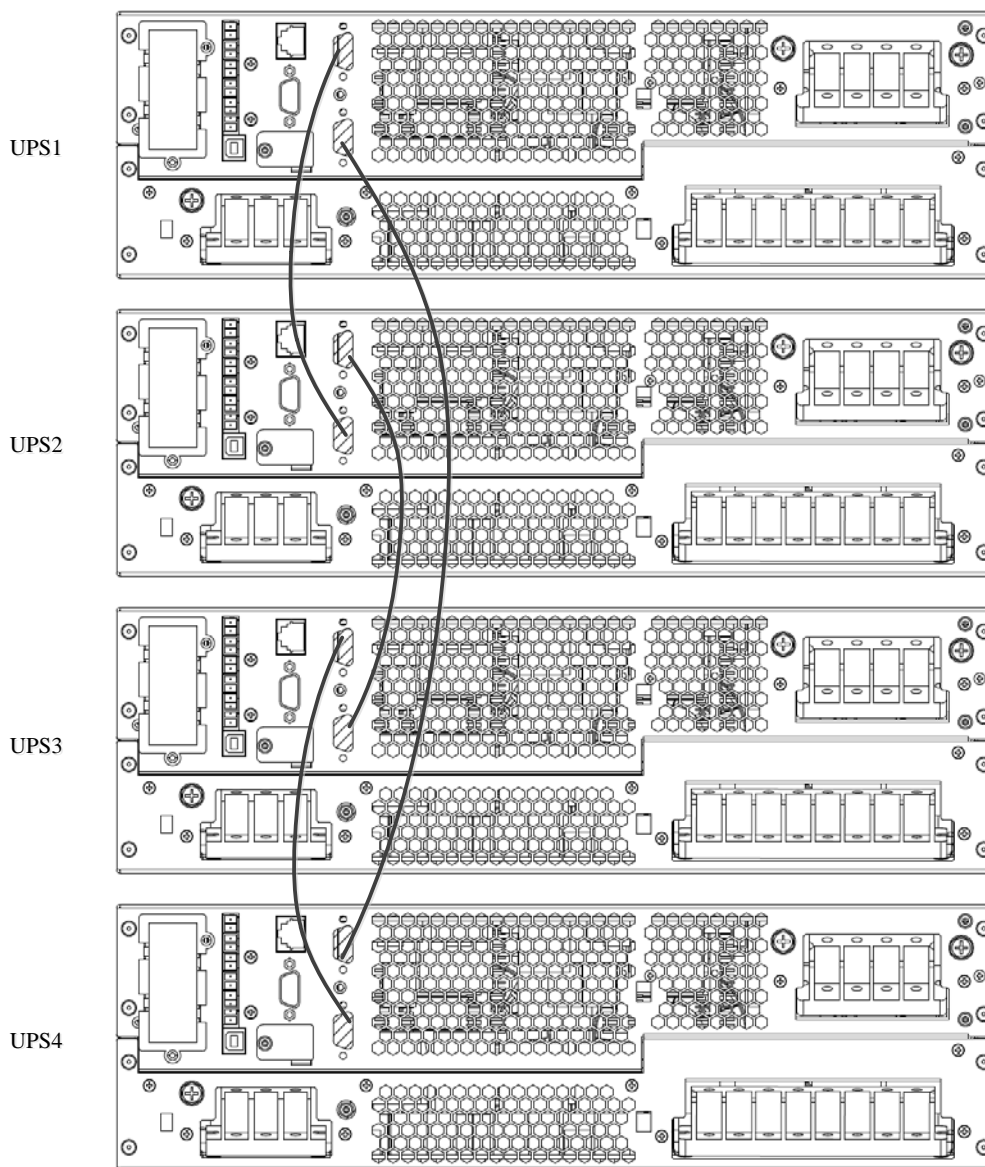

Figure 3-3 Cable connection schematic diagram of 3 + 1 parallel system



1. The Vertiv parallel cables must be used for the parallel system.
2. If the parallel communication fault occurs during the parallel commissioning or operation, just shut off the system and check whether the connection of the parallel cables are correct.
3. During parallel system operation, do not unplug the parallel cables to avoid system damage risk.

3.4.3 Connecting Battery Cables

In the parallel system, the UPS can support either Distributed battery System (Independent battery systems on each UPS unit) or Centralized battery system (Shared battery system by UPS units).



Each UPS should be equipped with an independent battery MCB. Refer to Table 2-4 for selection of the battery MCB.

In Distributed Battery System

When each UPS of the parallel system uses the independent battery string, the battery cables connection of each UPS in the parallel system is the same as that of the single UPS, refer to 2.6.2 *Connecting Battery Cables* for the installation method. The schematic diagram of battery strings in 1 + 1 parallel system with independent battery strings is shown in Figure 3-4. Refer to 2.6 *Connecting Power Cables to configure an MCB*.



*Ensure that the LCD settings are correct when using the battery strings independently for the parallel system, refer to 3.5.2 *Parallel System Parameters Settings* for details.*

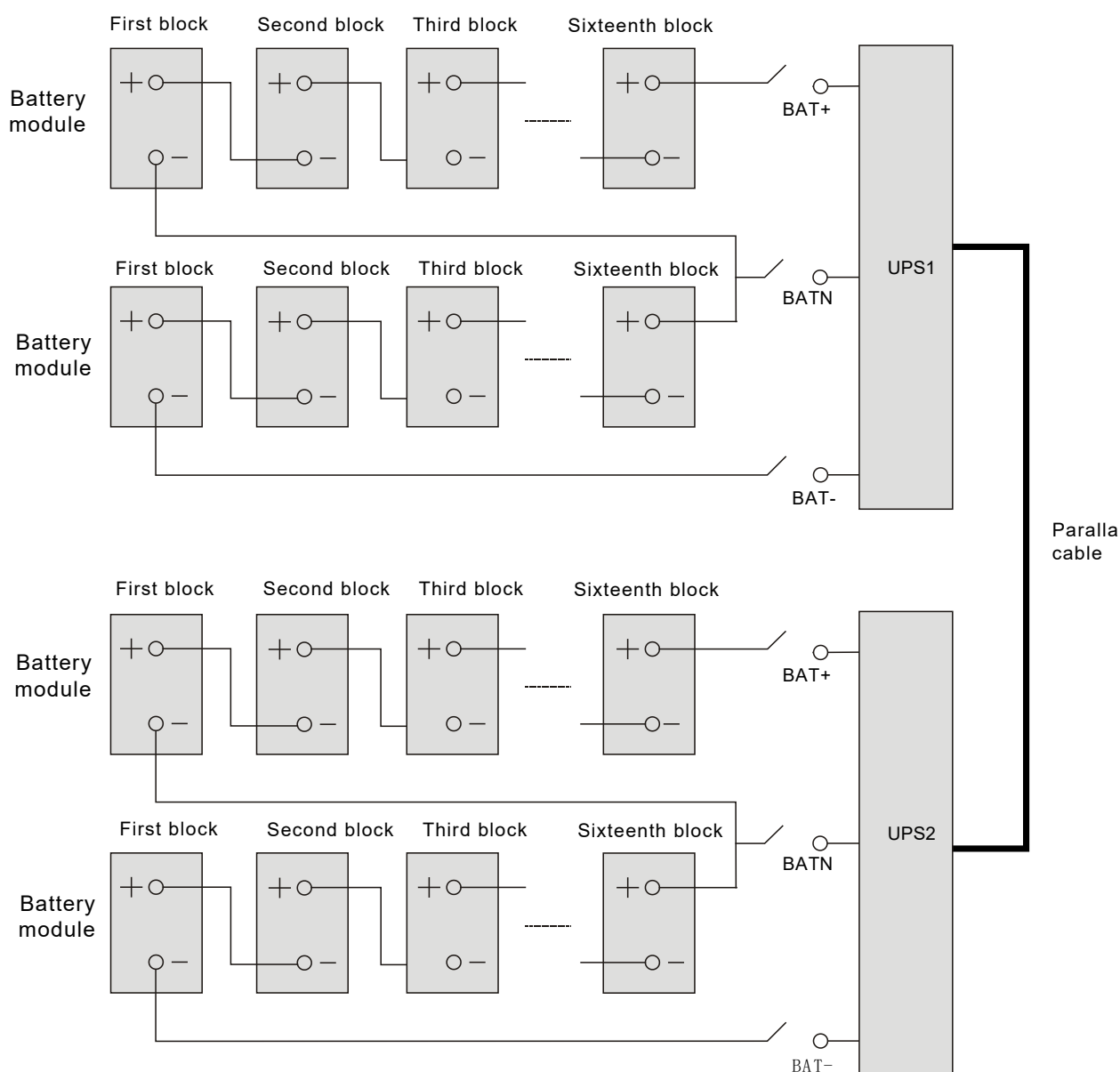

Figure 3-4 Connection principle diagram upon using battery strings independently

Centralized Battery System

Using the centralized battery arrangement in the parallel system can save user's investment in equipment.



1. To ensure the abundant backup time of the battery, it is recommended to use the external battery cabinet with larger capacity.
2. The UPS shares the battery system, make sure that in each of the UPS enable common battery function. Refer to 3.6.5 Settings Parameter of LBS.

Wiring

Power off the parallel system completely, disconnect the battery MCBs of all single UPSs, and then use battery cables (refer to 2.6 *Connecting Power Cables* for the cables and the MCBs) to connect '+', 'N', '-' and 'PE' terminals of the battery strings respectively to 'BAT+', 'BAT-', 'BAT N' and 'PE' terminals of the corresponding I/O terminal block of the UPS in the parallel system through each battery MCB, as shown in Figure 3-5.

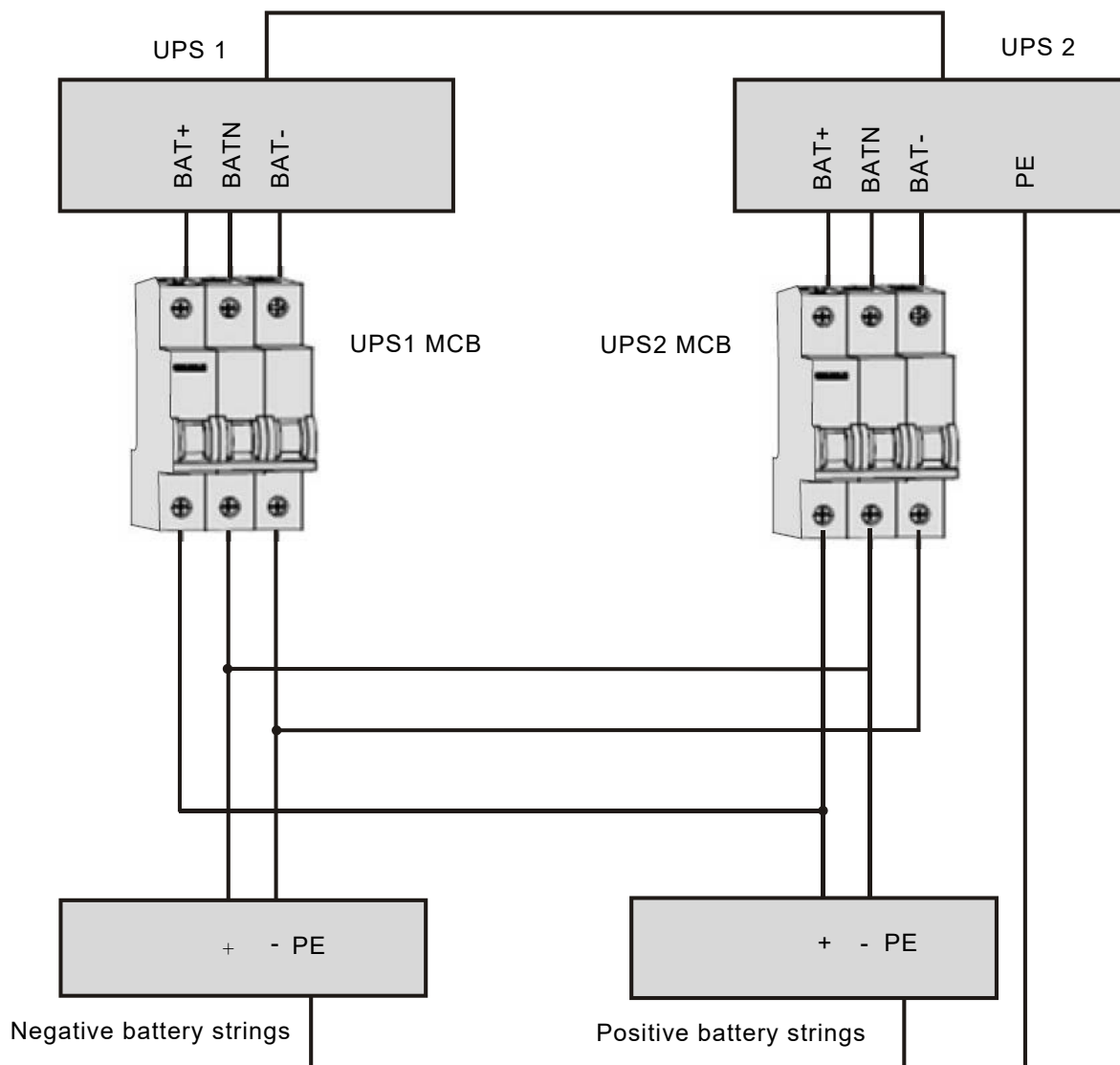

Figure 3-5 Connection diagram of shared battery string in 1 + 1 parallel system

Refer to Figure 3-6 to configure the positive battery string and negative battery string.

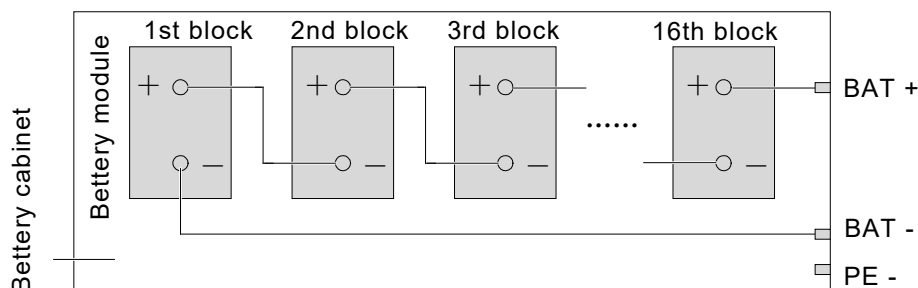

Figure 3-6 Internal connection diagram for positive battery string and negative battery string

Close the battery MCB of each UPS.

3.5 Commissioning Parallel System

3.5.1 Check Before Start-Up

1. Check and confirm that power distribution mode of the UPS and the 1 + 1 parallel POD (if configured) is correct; that connections of the power cables and the signal cables are correct and there is no short circuit.
2. Check that the battery installation and cable connection is correct and there is no short circuit, and that the positive pole and negative pole of the battery are correct. Especially when each UPS of the parallel system shares the battery strings, check these items carefully.
3. Check all the working status of the parallel system, ensure that the phase sequence of the main, bypass and output of each UPS is correct and consistent, that the connection of the parallel cable is reliable, and that the user load is not connected during power-on.
4. Measure and confirm that the mains voltage and frequency are normal.
5. The output terminals of the UPS and the 1 + 1 parallel POD (if configured) are energized upon the start-up. If the load is connected with the output terminals, make sure that the power to the load is safe.



The output terminals of the UPS and the POD (if configured) will be live upon start-up. When bypass of the single UPS in the parallel system is not consistent, the system fault may occur, check and confirm the bypass before power-on.

3.5.2 Parallel System Parameters Setting

The parallel parameters for all the UPSs in the parallel system should be set. As shown in Figure 3-7.

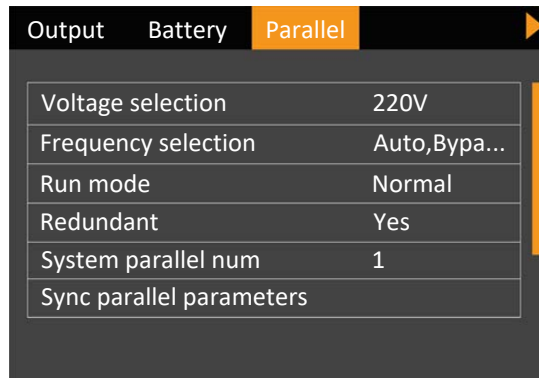

Figure 3-7 Settings for parallel parameters

The user can change these settings according to actual needs, refer to *Appendix 1 LCD Parameters Setting* for details. After the change, press the last item 'Sync parallel parameters' to validate the setting.

3.5.3 Power-On Commissioning For Parallel System

1. Set the parallel parameters of each UPS in the parallel system, then commission the inverter.

The specific commissioning procedures are as follows:

a) Make sure that the output MCBs of all UPSs in the parallel system are open, and then close the external input MCB of each UPS in the parallel system, the UPS is powered on at the same time. If 1 + 1 parallel POD is configured, close the corresponding input MCB and bypass MCB. At the same time, close the corresponding output MCB of the other UPS which is being tested, and make sure that the corresponding output MCB of the other UPS is open.



After the UPS external output MCB or POD output MCB is closed, the UPS output terminal block, POD output terminal block and load will be live, pay attention to personnel safety to avoid electric shock. Note whether it is safe to feed power to load.

b) The LCD displays the self-check screen, and the alarm indicator (red) and run indicator (green) are ON at the same time for about five seconds.

c) After the rectifier has been in normal operation state for about 30 seconds, the rectifier start-up is finished.

d) Refer to *3.5.2 Parallel System Parameters Setting* for the parallel parameters setting for each UPS. Note whether there is an alarm of 'Parallel comm. Fail', if yes, clear the fault according to Table 4-5. Carry out the following procedures if the UPS is running normally.

e) Press the power button of one UPS for 2 seconds, if 1 + 1 parallel POD is configured, press power button of the UPS which is being tested in the parallel system, then press Enter key to start the UPS. The run indicator (green) will blink, after 20 seconds, the inverter will start, and the run indicator will turn ON, if 1 + 1 parallel POD is configured, the other UPS will display no redundancy in parallel, ignore the prompt at the moment.

f) If the battery is not connected, the alarm indicator will be solid ON, and the buzzer will beep every seconds. If the battery is connected, the alarm indicator will turn OFF.

g) If the UPS is working normally, press the power button for two seconds to turn OFF the inverter.

h) Repeat the preceding step a) ~ step g) to power on and commission the inverter of other UPSs respectively.



Carry out the parallel commissioning after each UPS is working normally.

2. After confirming that the inverter of each UPS is normal, commission the parallel system, the specific procedures are as follows:

a) Close the external output MCB and input MCB of each UPS, and all UPSs are powered on at the same time. After the start of the rectifier is finished, press the power button of one UPS for two seconds, the run indicator (green) will be on. Measure whether the inverter output voltage is normal. If the 1 + 1 parallel POD is configured, close the corresponding input MCB, bypass MCB and output MCB of the POD.

b) Start the inverter of the second UPS, check whether there is an alarm on the LCD, and confirm that the UPS parallel works normally.

c) Follow the methods to start inverter of the third or the fourth UPS to connect UPS into the parallel system.



1. During the parallel power-on, confirm that the external output MCB of each UPS has been closed, and that all the inverter output of the UPSs are connected parallelly.

2. During the parallel power-on, confirm that the system is working normally, and then feed power to the load, to avoid load power failure.

3. If the user needs to add one UPS in the parallel system, follow the commissioning procedures below:

a) Check and confirm that the power distribution mode, each power cable and signal cable of the added UPS are well connected without short circuit. Check that the battery installation and cables connection are correct without short circuit, and that the positive and negative are correct.

b) Repeat steps a) to h) in Part 1 to complete the single unit commissioning of the added UPS. Then completely power off the UPS.

c) Ensure that the connection of power cable and signal cable is reliable.

d) Close the external input switch of the added UPS. After the system power-on, find any online UPS, and enter the interface shown in Figure 3-7. Set the system parallel No. from 'N' to 'N+1', then click the 'Sync parallel parameters'.

e) Close the external output switch of the added UPS once again, normally start the inverter after the rectifier start-up. Then check that the LCD has no alarm, and that the UPS parallel system works normally.



1. For 1+1 parallel system, when one UPS is faulty and needs to be replaced on line, the above operation steps are available too. The difference is no need to change parallel No., just click the 'Sync parallel parameters' for the online UPS.

2. Clicking the 'Sync parallel parameters' to achieve the synchronization of the items in parallel settings interface, and the parameters will affect the parallel system. The user should manually set other parameters according to actual needs.

3. When parallel system has output, 'Sync parallel parameters' function can only be achieved via the UPS with output, otherwise this function is invalid.

4. When adding a single unit in the parallel system, first ensure the parallel cables connection is correct, then power on the single unit.

3.6 Installation And Commissioning For Dual Bus System

3.6.1 Introduction

The dual bus system consists of two independent UPS systems; each UPS system consists of one or two parallel-connected single UPSs, or more parallel-connected single UPSs.

The dual bus system has high reliability, which is suitable for the load with many input terminals. For single UPS input load, you can add a static trigger switch (STS, optional) to start the standard Load Bus Synchronization (LBS) system.

Place the UPSs side by side, and connect the UPSs as follows:

The dual bus system adopts the LBS system to realize the output synchronization of the two independent (or parallel) UPS systems. One is the master system, and the other is the slave system. The operation mode of the dual bus system contains master system and/or slave system running in Normal mode or Bypass mode. The schematic diagram of the LBS system built by two UPSs is shown in Figure 3-8.

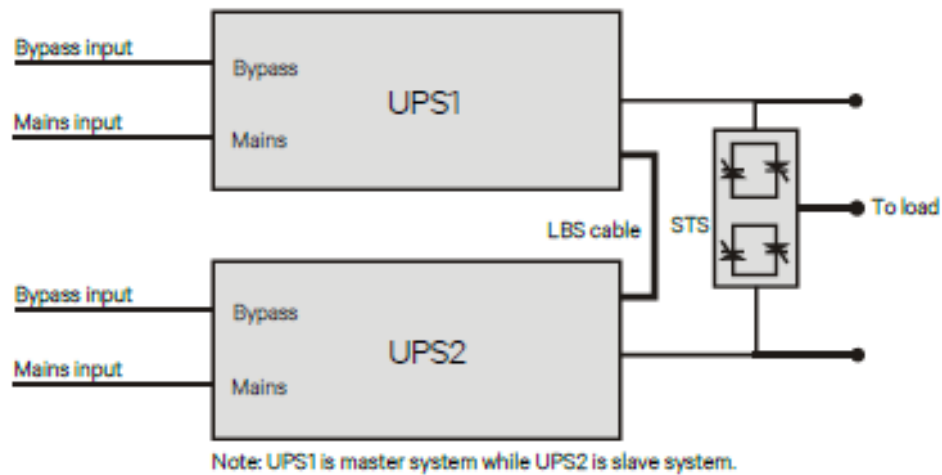

Figure 3-8 LBS system schematic diagram



Refer to 3.5 Commissioning Parallel System respectively for the settings of the parallel system.

3.6.2 Installing External Protective Device

See 2.4 External Protective Device for details of installation and type selection.

3.6.3 Connecting Power Cables

In dual bus system, refer to 2.6 Connecting Power Cables and 3.4 Connecting Power Cables to select the power cables for single UPS and parallel system respectively. The bypass input power and main input power must use the input terminal of the same neutral line. If the input terminal has leakage current, the leakage current protective device should be installed before the input terminal.

3.6.4 Connecting LBS Cables



1. The appearance of the LBS port is the same as the parallel port (see Figure 1-3).
2. For the dual bus system formed by the parallel UPS, it is recommended to prepare two LBS cables used to connect any two parallel/LBS ports of the two parallel system, which is used for reliable connection.

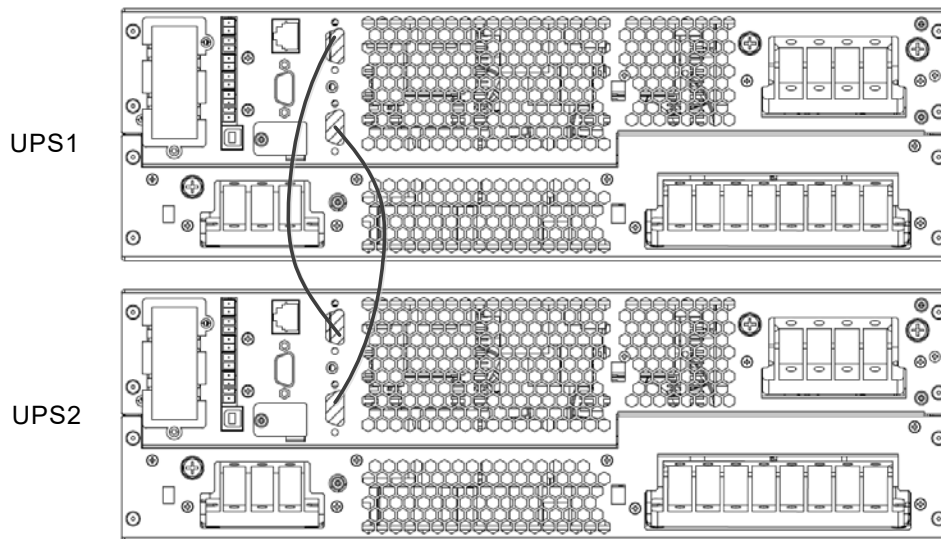

Figure 3-9 LBS cable connection

3.6.5 Setting Parameters Of LBS

The LBS parameters setting interface is shown in Figure 3-10.

Procedures for setting LBS parameters:

Through the 'Settings' -> 'System' -> 'LBS', you can set the LBS according to actual needs.

There are three items of LBS for selection: Disable, Slave, Master.

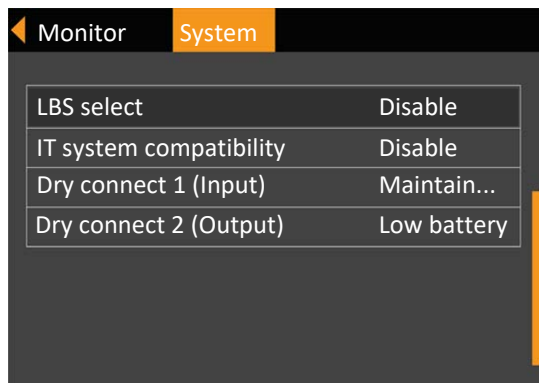

Figure 3-10 LBS parameters setting interface

The LBS is the load synchronous system, which is used to implement the output voltage phase synchronization of the two sets of UPS system. Two sets of UPS system can be two single UPS or two sets of UPS parallel system.

You can manually set the 'Master' and 'Slave' through the LCD.

The UPS which is set to LBS master can send synchronization signal to LBS slave according to the own inverter voltage phase. After the slave receives the synchronization signal sent by the master, the slave will adjust its inverter voltage phase so as to realize the inverter voltage phase is synchronized with the master.

Through the above to realize the inverter voltage phase synchronization of two sets of UPS system, and realize the reliable transfer between the two sets of UPS output voltage and STS, then provide the reliable uninterrupted power supply to the load.

4.1.2 LED Indicators

The LED indicators consist of the run indicator and alarm indicator. Table 4-1 provides a description of the these indicators.

Table 4-1 Description of LED indicators

Indicator	Color	State	Meaning
Run indicator	Green	On	UPS has output
		Blinking	Inverter is starting
		Off	UPS has no output, inverter is starting
Alarm indicator	Yellow	On	Alarm occurs
	Red	On	Fault occurs
	/	Off	No alarm, no fault

4.1.3 Audible Alarm (Buzzer)

The UPS operation is accompanied with the following two different kinds of audible alarms shown in Table 4-2.





Table 4-2 Description of audible alarm

Sound	Meaning
Continuous beep	Sound is generated when the UPS fault appears, such as fuse or hardware failure
One beep every 0.5 second	Sound is generated when the UPS critical alarm appears, such as Inverter overload
One beep every second	Sound is generated when the UPS critical alarm appears, such as battery low voltage
One beep every 3.3 second	Sound is generated when the UPS general alarm appears

4.1.4 LCD And Functional Keys

The operation and display panel include five functional keys, the respective functions are described in Table 4-3.

Table 4-3 Description of control buttons

Functional key	Silkprint	Description
Confirm		Used to confirm or enter
Up		Used to page up, turn left or add value, etc.
Down		Used to page down, turn right or reduce value, etc.
Escape		Used to back, escape, cancel or forbid operation
Power		Used to power on, power off or transfer to Byapss mode

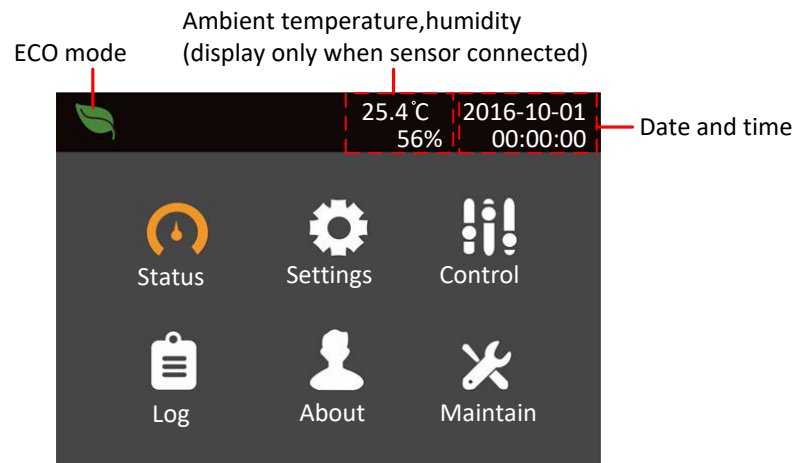

Figure 4-2 LCD screen

LCD provides you with the user-friendly interface and the 320 × 240 dot matrix image display. The user-friendly and menu-driven LCD allows you to easily browse through the UPS input, output, parameters of the load and the battery, learn about the current UPS status and alarm message, perform functional settings and control operation. The LCD also stores historical alarm records that can be retrieved for reference and diagnosis.

4.1.5 Initial Start-up Guidance

When the UPS is the initial start-up, the interface shown in Figure 4-3 will appear to guide the user to set basic parameters of the UPS.

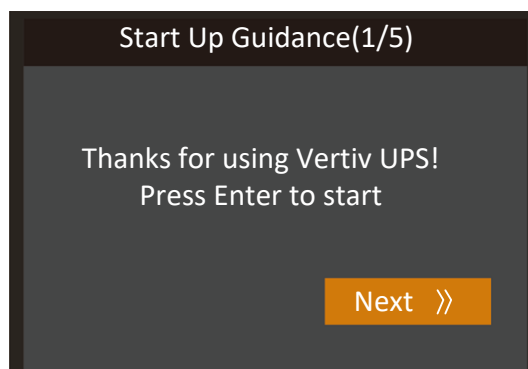

Figure 4-3 Initial start-up guidance (1)

Welcome page

Click **Next** to start the guidance.

Language, date and time page

At this page, you can set the language, date and time you need.

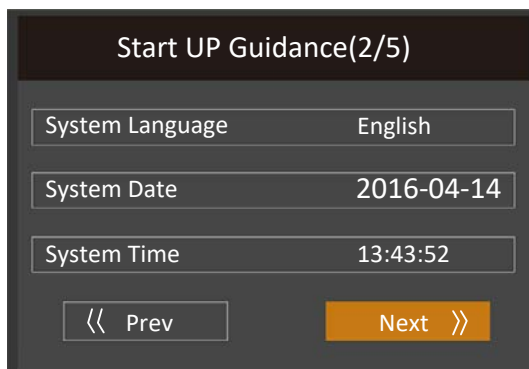

Figure 4-4 Initial start-up guidance (2)

Battery parameter page

At this page, you can set the battery cell number and total Ah.

For 30kVA model, the 'Battery series' are 32, 34, 36, 38 and 40 selectable. See right diagram in Figure 4-5.

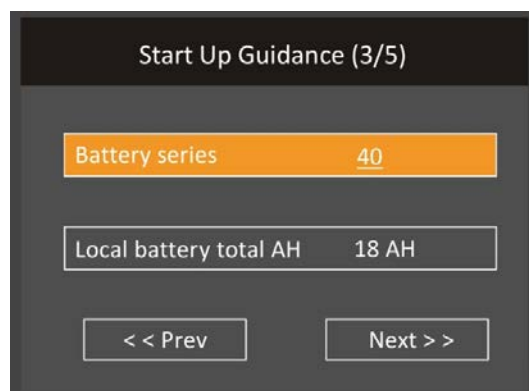

Figure 4-5 Initial start-up guidance (3)

Output page

As shown in Figure 4-6, you can set output voltage, output frequency.

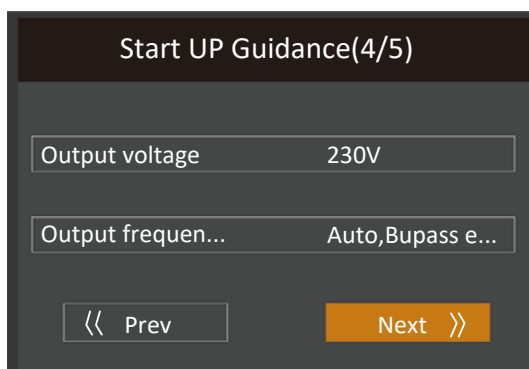

Figure 4-6 Initial start-up guidance (4)

Finish page

After the start-up, the user can operate the UPS normally,

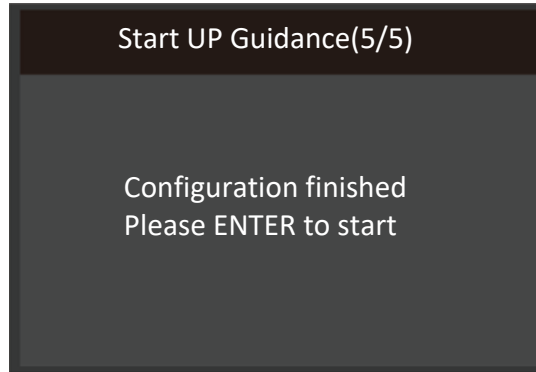

Figure 4-7 Initial start-up guidance (5)

4.2 LCD Menu Structure

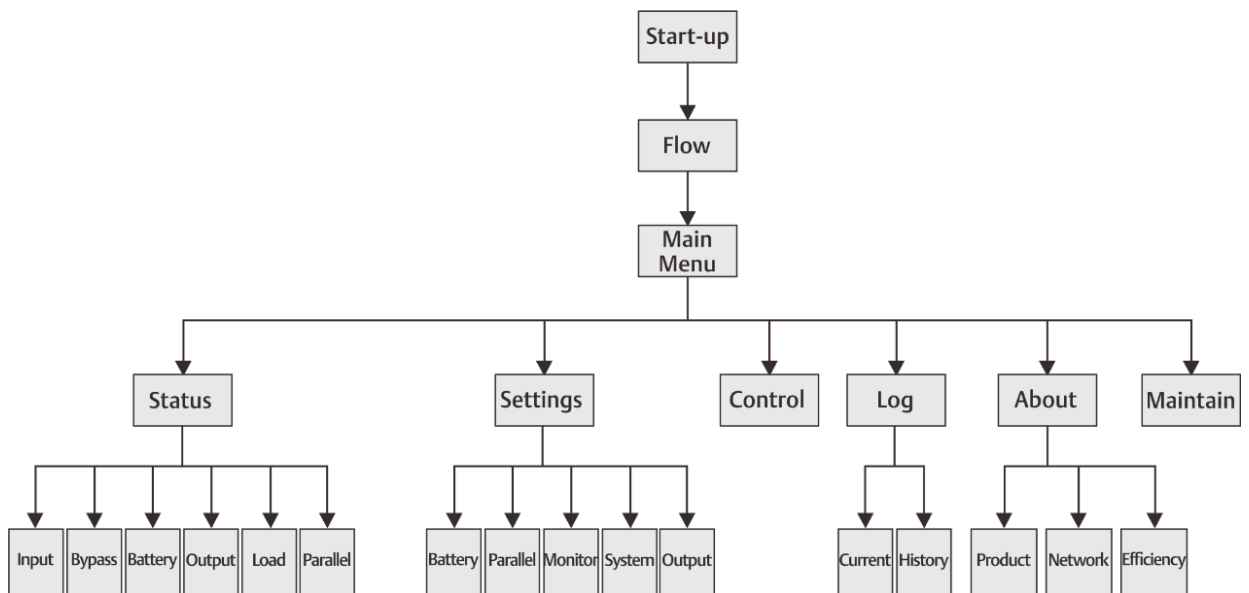

Figure 4-8 LCD menu structure

4.3 LCD Screen Types

4.3.1 Start Screen

Upon UPS start-up, the UPS executes the system self-test, and the start screen will appear and remain for about 10 seconds, as shown in Figure 4-9.



Figure 4-9 Start screen

4.3.2 Flow Screen

After the self-test of the UPS, the flow screen shown in Figure 4-10 will appear.

The flow screen is the total status view of the UPS, includes input, bypass, rectifier, battery, inverter and output, etc.. The working modes with color display while the invalid modes with gray display.

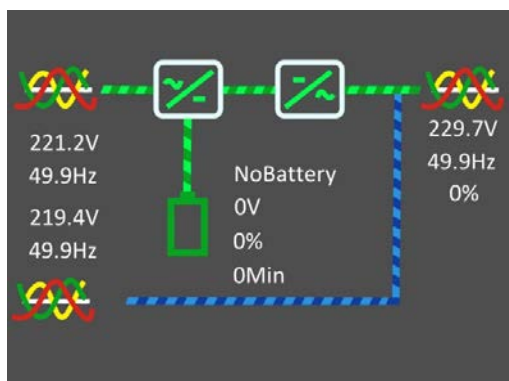

Figure 4-10 Flow screen

At the flow page, press the  key to enter the primary screen.

4.3.3 Main Menu Screen

The main menu screen is composed of six icons: Status, Settings, Control, Log, About, Maintain. As shown in Figure 4-11.

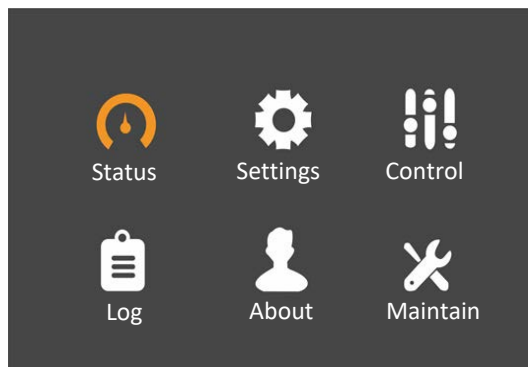

Figure 4-11 Main menu screen

At main menu screen, press the **Esc** key to back to the flow screen. Press the **▲** or **▼** key to switch the cursor to select the submenu you need, then press the **Enter** key to confirm it.

4.3.4 Submenu Screen

The submenu screen contains the UPS parameters and item settings.

After entering the submenu screen, if there is a tab control, just move the cursor to the tab.

At this time, you can press the **▲** or **▼** key to switch the tab. Press the **Enter** key to move the cursor to a certain item.

After entering the submenu screen, if there is no tab control, then the cursor will stop at a certain item.

Press the **Esc** key to back to the previous screen.

For details about the submenu screen, see following pages.

Status page

The Status page contains the Input, Bypass, Battery, Output and Load.

See below:

Input	Bypass	Battery	Output
L-N voltage(V)	242.8	244.1	243.2
L-N current(A)	0.2	0.2	0.2
Frequency(Hz)	59.98	59.98	59.98
L-L voltage(V)	420.4	422.7	421.5
Power factor	0.60	0.60	0.60
Energy(kWh)	204		

Input	Bypass	Battery	Output
L-N voltage(V)	220.5	222.1	221.6
Frequency(Hz)	50.02	50.02	49.99
L-L voltage(V)	382.9	384.9	382.9

Input	Bypass	Battery	Output
Battery status		210.3	210.5
Battery voltage(V)		0.0	0.0
Battery current(A)		0.00	0.00
Backup time(Minut...)		0.0	
Remaining capacit...		0	
External battery c...		0	

Input	Bypass	Battery	Output
L-N voltage(V)	229.7	230.6	230.0
L-N voltage(A)	0.0	0.0	0.0
Frequency(Hz)	50.02	50.02	49.99
L-L voltage(V)	382.9	384.9	382.9

Load			
Sout(kVA)	0.00	0.00	0.00
Pout(kW)	0.00	0.00	0.00
Power factor	0.00	0.00	0.00
Load percent(%)	0.0	0.0	0.0

Settings page

The Settings page contains the Output, Battery, Parallel, Monitor, System, and Outlet. For details about the parameters setting, refer to *Appendix 1 LCD Parameters Setting*.

See below:



The screenshots show the following settings:

Main Menu: Status, Settings, Control, Log, About, Maintain.

Output Settings:

Voltage selection	220V
Startup on bypass	Disable
Frequency selection	Auto, Byp...
Inverter sync range	±3.0Hz
Bypass voltage upper li...	+20%
Bypass voltage lower li...	-40%
Bypass frequency range	±10Hz

Battery Settings:

Shared battery	Disable
Local battery total AH	36AH
Low battery time	2 min
Battery replaced time	2000-01-0...
Battery test interval	Disable
Battery test weekday	Wednesday
Battery test time	00:00:00

Parallel Settings:

Battery series	32
Dischg proctct time	4320 min
Equal charge enable	No
Temp compensation	Disable
Replace battery	

System Settings:

Voltage selection	220V
Frequency selection	Auto, Bypa...
Run mode	Normal
Redundant	Yes
System parallel num	1
Sync parallel parameters	

Monitor System	
Language	English
Date	2018-06-22
Time	15:20:08
Audible alarm	Enable
Card slot protocol	YDN23
UPS Comm. Address	1
Control port protocol	Sensor

Monitor System	
Modbus address	1
Change settings password	

Monitor System	
Auto restart	Disable
Auto restart delay	0 sec
Guaranteed shutdown	Disable
Remote control	Enable
Remote power on delay	0 sec
Remote shutdown delay	0 sec
Redundant	Yes

Monitor System	
Auto restart	Disable
Auto restart delay	0 sec
Guaranteed shutdown	Disable
Remote control	Enable
Remote power on delay	0 sec
Remote shutdown delay	0 sec
Redundant	Yes

Control page

The Control page contains the Turn ON/OFF/to BYPASS, and Manual battery test, etc.. See below:

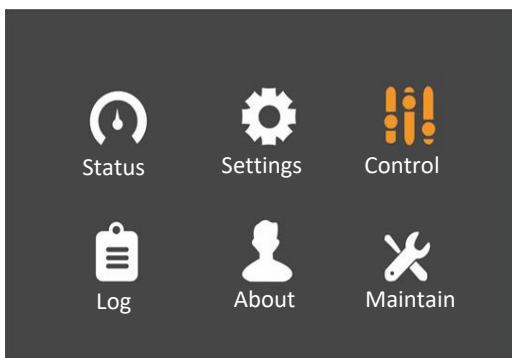

Turn on/off/to bypass	
Mute/Unmute audible alarm	
Start/Stop battery manual test	
Clear faults	
<input type="checkbox"/> Power on time	2000-01-01 00:00:00
<input type="checkbox"/> power off time	2000-01-01 00:00:00

Log page

The Log page contains the Current and History. See below:

The screenshot shows the Log page interface. On the left, there are six navigation icons: Status (gauge), Settings (gear), Control (three vertical bars), Log (clipboard), About (person), and Maintain (wrench). On the right, there are two panels. The top panel is titled 'Current' and shows two log entries:

Event ID	Description	Time	Location
01	No battery	2000-01-01 03:50:54	ND03
02	UPS has no output	2000-01-01 03:50:35	NE08

The bottom panel is titled 'History' and shows three log entries:

Event ID	Description	Time	Location
01	Input abnormal	2016-10-01 00:00:00	NA03
02	No battery	2016-10-01 00:00:00	ND03
03	Bypass abnormal	2016-10-01 00:00:00	NC00

About page

The About page contains the Product, Network, and Efficiency. See below:

The screenshot shows the About page interface. On the left, there are six navigation icons: Status (gauge), Settings (gear), Control (three vertical bars), Log (clipboard), About (person), and Maintain (wrench). On the right, there are three panels. The top panel is titled 'Product' and shows the following information:

Field	Value
Product type	ITA-30k00AL33...
Serial number	21012019262184...
Time since startup	00Day 01Hour 2...
Boot FW version	V110
Monitor FW version	V000A003D006
Inverter FW version	V000A005D001
Rectifier FW version	V000A005

The middle panel is titled 'Network' and shows the following information:

Field	Value
Connection status	Disconnected
IPv4 address	192.168.1.10
Subnet mask	255.255.255.0
Gateway address	192.168.1.1
MAC address	00:00:00:00:00:00
SNMP NMS address	192.168.1.100

The bottom panel is titled 'Efficiency' and shows a line graph of Efficiency (%) versus Load Rate (%). The graph shows a curve that starts at approximately 94.0% efficiency at 0% load, rises to a peak of about 96.5% at 50% load, and then gradually declines to about 95.5% at 100% load.

Load Rate (%)	Efficiency (%)
0	94.0
25	95.5
50	96.5
75	96.0
100	95.5

Maintain page



The Maintain page needs correct password and for Vertiv service engineer operation only.

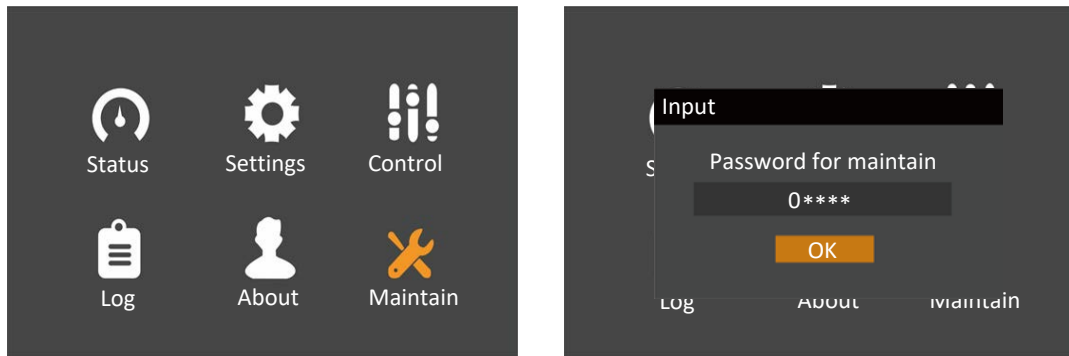

4.3.5 Default Screen

During the UPS operation, if there is no alarm within two minutes, the default screen shown in Figure 4-12 will appear. At the default screen, if there is an alarm or a fault, or the user press any key, the Flow screen will appear again.



Figure 4-12 Default screen

4.4 Prompt Window

A prompt window is displayed during the operation of the system to alert you to certain conditions and/or to require your confirmation of a command or other operation. Table 4-4 lists the prompts and meanings.

Table 4-4 Prompts and meanings

Prompt	Meaning
System setting is different, please check	When the parallel parameters are different, the prompt will appear
Cannot set this online, please shut down output	If the user wants to change some important settings under condition of output (output voltage, output frequency, output phase No.), the prompt will appear
Incorrect password, please input again	The prompt will appear when the user incorrectly input the Settings password
Operation failed, condition is not met	The prompt will appear when the user wants to execute a certain operation but the condition is not met
Password changed OK	The prompt will appear when the user successfully change the Settings password
Fail to change password, please try again	The prompt will appear when the user tries to change the Settings password but input two different new passwords
The time cannot be earlier than system time	The prompt will appear when the user set the time of 'Turn on delay' or 'Turn off delay' is earlier than the current system time
Turn on failed, condition is not met	When users press the power button (or execute the command of 'Turn on/Turn off/to Bypass' under 'Control' page), the prompt will appear

4.5 UPS Alarm Message List

Table 4-5 gives all UPS alarm messages based on the 'Current' and 'History' menus.

Table 4-5 UPS alarm message list

Alarm message	Description
Communication fail	Internal communication is abnormal, please check the communication cables are connected correctly or not
Rectifier fault	The rectifier is faulty and off
DC/DC fault	The discharger is faulty, because the bus voltage exceeds the setting range when discharger starts or soft starts
DC bus abnormal	The inverter is off when DC bus voltage is faulty. The load will transfer to bypass if the bypass is available
Charger fault	The charger output voltage is abnormal, and the charger is off
Aux. power fault	The auxiliary power output voltage exceeds the normal range
Input backfeed	Battery mode. The mains relay short circuit, and the difference between mains and battery voltage is less than the setting range
Inverter fault	The inverter is off when the inverter output voltage and current exceed the setting range. If bypass is available, the UPS will transfer to bypass mode, otherwise the system will power off
Output short	Check that the output cables are not shorted
Bypass backfeed	Battery mode. The bypass relay is shorted or the SCR is damaged
Output off, voltage is not zero	When there is no output, the system detects that the output has a voltage

Alarm message	Description
Inverter relay welded	The inveter relay is shorted
Parallel No. abnormal	The parallel online number is different from the setting number. Please check that the parallel number at 'Settings' page is the same as the actual online number, and that the parallel cables are normal
Parallel comm fault	The local UPS and its online frequency configuration is different or the parallel address is conflicted. Please check that the parallel system paramerte setting is the same as the local parameter setting
Parallel cable connection abnormal	Detect the parallel cables are loosened
Input neutral lost	The AC input mains N line is not detected. Please check that the input N line is opened or loosened
Input ground lost	Check that the PE line is well connected, and the alarm can be cleared on line
Input phase reversed	The mains AC input phase is reversed. Normally, phase B lags phase A of 120 degrees, and phase C lags phase B of 120 degrees. Check that the UPS mains input phase sequence is correct. If not, just modify it
Input abnormal	The retifier and charger are off due to the mains voltage and frequency exceeding normal renage. Check that the rectifier input phase voltage and frequency exceed the normal range or that the mains has power-off
Rectifier overload	The output power is larger than the rectifier overload point. Check that the input volatge meets the output load, mains input 176V ~ 100V, the load 100% ~ 50% linear derating
Battery reversed	The battery positive and negative are reversed. Please reconnect the battery and check the battery cables connection
Battery low pre-warning	This alarm occurs when the battery reaches the EOD. After the pre-warning, the battery capacity allows two minutes discharge at full load. The user can set the time ranging from 2min ~ 30min, (2 min by default). Please shut down the load timely
Battery voltage abnormal	When battery is connected, the system checks that the battery voltage exceeds the normal setting range. Check that the battery terminal voltage exceeds the normal range
No battery	Check the battery and battery cables connection
Battery series not qualified	The actual connected battery cells are different from the setting cells. Please change to the same
Battery aged	The battery capacity is less than 25% of the initial capacity. Battery replacement is recommended
Battery test fail	The battery low voltage is detected when the battery has manual or peroidal self-test. Battery replacement is recommended
Battery overtemp	Battery ambient temperature too high. Check that the battery ambient temperature is higher than setting value 40 ~ 60°C (default: 50°C)
Battery cabinet not connected	The battery cabinet is not connected to the system
Fan fault	At least one fan is faulty. Check that the fan is blocked or the cables connection is loosened
System overtemp	Internal heat sink temperature too high, and the inverter is off. Only each module heat sink temperature decreased to the setting value can you silence the alarm. The system can automatically start after overtemperature fault is solved. If overtemperature, please check: 1. Ambient temperature too high or not 2. Dust is blocked or not 3. Fan fault or not

Alarm message	Description
Inverter overload	Inverter load capacity is larger than the rated value, overload delay time is up, inverter shuts down. If bypass is available, the system will transfer to the bypass mode, otherwise the output is failure. Check that the actual inverter load capacity, if overloaded, just reduce the load capacity, and the system will transfer to the inverter mode after five minutes with alarm cleared
Bypass phase reversed	The bypass voltage phase sequence is reversed. Normally, phase B lags phase A of 120 degrees, and phase C lags phase B of 120 degrees. Check that the UPS bypass input phase sequence is correct. If not, just modify it
Bypass overcurrent	The bypass current exceeds the rated value. Overload delay time is up, inverter shuts down
Parallel bypass cable connection abnormal	The bypass phase number is different from the output phase number under 'Monitor'. Please check that the bypass cables connection is the same as the configured phase number
Byapss abnormal	Maybe caused by bypass voltage and frequency outside of range, bypass power-off and incorrect bypass cables connection. 1. Check that the bypass voltage and frequency are within the setting range. 2. Check the bypass cables connection
Bypass abnormal in ECO mode	The ECO mode is available, and the bypass voltage and frequency are outside of the setting range. Check that the bypass input voltage and frequency are within the setting range
Input neutral-ground abnormal	The output and enclosure are shorted. Check whether the output cables connection and the enclosure are shorted or not
Output pending	Remote shutdown is enabled, and the system will be off
Output voltage abnormal	The internal output disconnect. Check output fuse and relays
Output disabled	The system is in standby state, and the dry cntact shutdown is enabled. Check whether the shutdown dry contact is enabled or not
Version incompatible	The version between monitoring board and DSP board is incompatible
Input neutral-ground abnormal	Short circuit between bus and enclosure or between battery and enclosure. Check whether the bus and battery cables connection are shorted with the enclosure or not
On maintenance bypass	The dry contact in maintenance bypass state is activated
Battery mode	The UPS is on battery, and the inverter starts
Bypass mode	The UPS is on bypass
System overload	The parallel system load capacity is larger than the max. load capacity outputed by parallel sets. Confirm the parallel system load capacity, if overloaded, just reduce it
Loss of redundancy	After the parallel redundancy is enabled, the system load capacity is larger than the rated load of (online set minus one)
Load sharing abnormal	Load sharing is abnormal in parallel system
System parallel settings async	Check that parallel setting parameters of each unit are the same
Local parallel settings async	Check that the Settings page is the same between this local unit and other units
LBS abnormal	Check whether the LBS cables are nromal, the system is in stand-by state, or system on bypass and the bypass unable to trace
REPO	Shutdown caused by the REPO terminal Normally Closed contact open
Bypass phase reversed	During parallel connection, the bypass phase sequence is not the same. Check the parallel bypass cables connection

Alarm message	Description
System battery low pre-warning	In parallel system, all the devices powered by the battery inverter have battery low voltage pre-warning
Battery test started	The battery periodical self-test and manual self-test started
Battery test stopped	The battery periodical self-test or manual self-test finished
EOD turn off	The inverter is off due to EOD. Check the mains power-off state and recover the mains in time
Guaranteed shutdown	Under forced EOD mode, the battery discharging finished, then system shuts down
Shutdown due to overtemp	During the UPS operation, the system checks that the heat sink temperature exceeds the setting range. If overtemperature, please check: 1. Ambient temperature too high or not 2. Dust is blocked or not 3. Fan fault or not
Remote shutdown	Dry contact activated at any mode shutdown
Remote power-on	Remotely power on
Remote shut-off	Remotely power off
Load off due to shutdown on battery	Shutdown in battery mode
Output off due to bypass abnormal	The bypass is abnormal, and the bypass is in standby state from working state. Check that the bypass input is normal
Battery to utility transition	The UPS is powered by the mains instead of the battery
Manual power-on	Set power-on via LCD panel
Manual shutdown	Set shutdown via LCD panel
Operating on inverter	The UPS output state is on inverter
Battery series set to 32 (32~40)	The battery cells changed
Restore factory defaults	Under UPS standby state, set 'Restore Factory Defaults' function via the Maintain page
UPS is out of service	The UPS is out of service
System parallel settings start sync	Manually set the 'Sync parallel parameters' command to activate the event
Local settings sync OK	Local parameters are successfully synchronized
System settings sync OK	All the parameters are successfully synchronized
Load off due to output short	The inverter short circuit or the bypass short circuit. Please check it
Output off due to overload & bypass abnormal	The output is off due to output overload and bypass abnormal. Please check it
Parallel No. abnormal	The parallel online number and the configured number are different. Please check that the parallel number under Setting page is the same as the actual online number, and that the parallel cables are normal
Bypass disabled	In Settings->Output->Frequency selection, 'Auto, BypDisa; 50Hz, BypDisa; 60Hz, BypDisa' is set, the LCD will generate BypDisa alarm

Alarm message	Description
On intelligent sleep mode	After the intelligent sleep mode is enabled, the system has N sets of inverter start-up. When the system meets the sleep requirement (Condition of entering sleep mode: Shared large battery string (If no large battery string, the sleep mode will cause the battery charging failure, host sleep enable, inverter side no fault or alarm, rectifier side no fault or alarm, with battery but large battery no charging need, rectifier not on battery mode, wait for 1h after exiting the former sleep, not master and the local unit ID number except sleep module has no start-up command within 5 minutes). When the N minus 2 units' rated load is larger than the existing system rated load capacity, the unit with the largest ID number starts to enter sleep mode (inverter off), at this time, the N minus 1 units are working in inverter mode. The N minus 3 units are larger than the current system rated load capacity, and the unit with the largest ID number keeps sleep mode
Battery EOD	Battery end of discharge
Faults cleared	Press the 'Clear faults' button under 'Control', then the system will record this event
Manual shut off	After the user shuts the UPS output, then the system will record this event
System warning	In parallel system, the alarm occurs when UPS's self-adapting output frequency is inconsistent. Solution: Power on again
System fault	The alarm occurs when model identification is incorrect. Solution: Contact service manager



If the alarm is caused through setting the software value by Vertiv authorized engineer, and when you wish to change the setting values, please get in touch with the Vertiv local customer service center.

5 UPS Operation Instructions

This chapter gives a detailed description of the UPS operation procedures.

During the operation, the buzzer alarm may appear, at this point, you can press the  key for three seconds to silence the audible alarm.



Hazardous mains and/or battery voltage exists behind the protective cover

1. No user accessible parts are located behind the protective covers that require a tool for removal.
2. Only qualified service personnel are authorized to remove such covers.
3. If maintenance for rack is needed, notice that the neutral line is live.

5.1 UPS Start-Up

The start-up procedures can be performed after the installation is completed, the system has been commissioned by authorized engineer and the external input MCBs are closed.



This procedure results in mains voltage being applied to the UPS output terminals. Confirm that the load power is safe, if there is a load to be connected with the UPS output terminal. Ensure that the load is isolated with the UPS output terminal, if the load is not ready for accepting the power.

The start-up mode of the single UPS includes normal mode start-up and battery mode start-up; refer to 2.7.3 Normal Mode Start-Up and 2.7.4 Battery Mode Start-Up for details.

5.2 Transfer Procedures Between Operation Modes



The Inverter operation mode include Normal mode (mains inverter) and Battery mode (battery inverter).

5.2.1 Transfer From Normal Mode To Battery Mode

In case of mains failure, the UPS will transfer to Battery mode. If you wish to transfer the UPS from Battery mode to Normal mode, wait few seconds for mains input recovery. After about Ten seconds, the rectifier will automatically restarts and the inverter restores the power.

5.2.2 Transfer From Inverter Mode To Bypass Mode

In standby mode, press and hold the power button. If the rectifier and inverter are normal, the interface shown in Figure 5-1 will appear, select 'YES' to turn on the UPS.

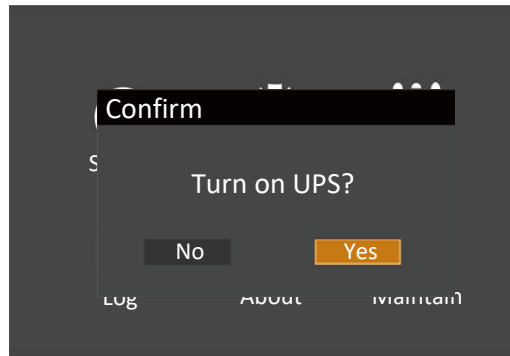

Figure 5-1 Turning on UPS

In Inverter mode, press and hold the power button. If the bypass is normal, the interface shown in Figure 5-2 is displayed. Select 'To the Bypass' and click OK to transfer the UPS to Bypass mode; select 'Turn off UPS' and click OK to turn off the UPS.

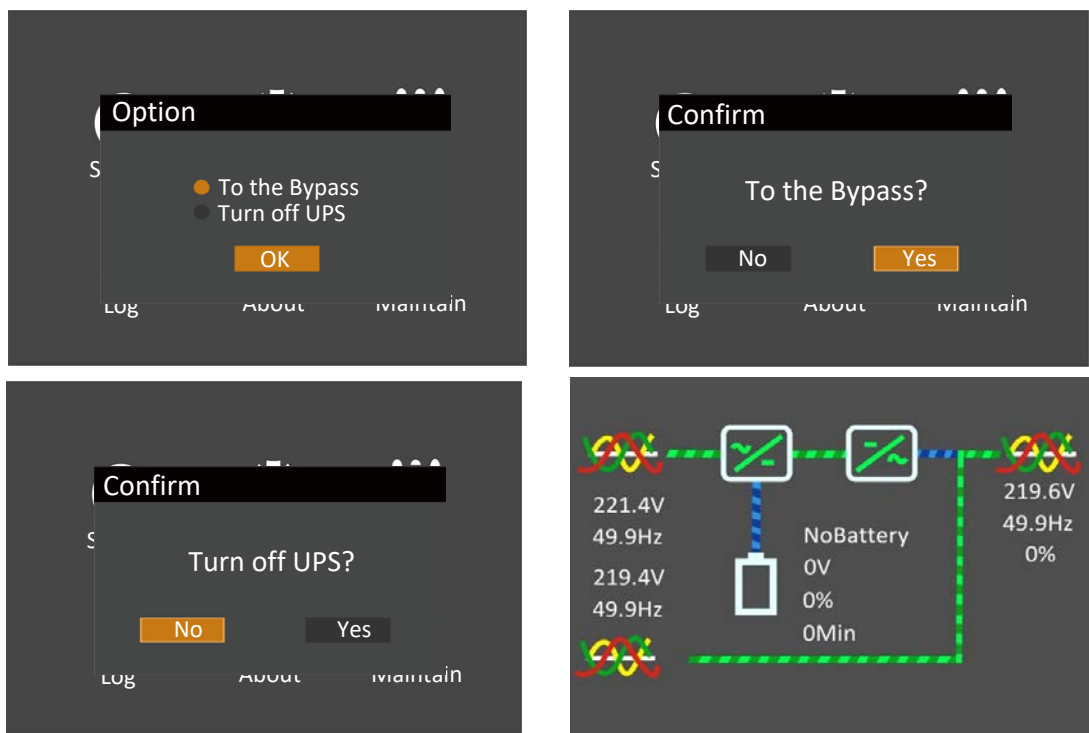

Figure 5-2 Bypass normal interface

In Inverter mode, press and hold the power button. If the bypass is abnormal, then the interface shown in Figure 5-3 will appear, select 'YES' to shut down the UPS output.

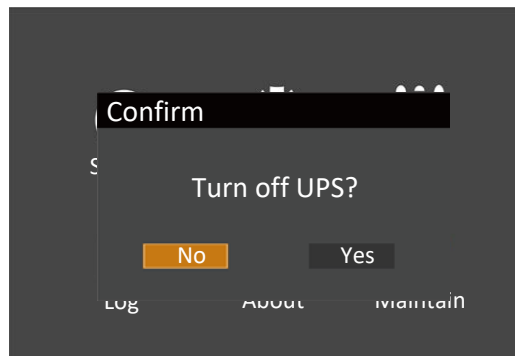

Figure 5-3 Bypass abnormal interface



In Bypass mode, the load is directly fed by the mains power instead of the pure AC power from the inverter.

For the detailed information of the Normal mode, Bypass mode, Battery and Maintenance Bypass mode, please refer to 1.5 UPS State And Operation Mode.

5.2.3 Transfer From Bypass Mode To Inverter Mode

In Bypass mode, press and hold the power button.

If the ECO mode is not turned on, the interface shown in Figure 5-4 is displayed.

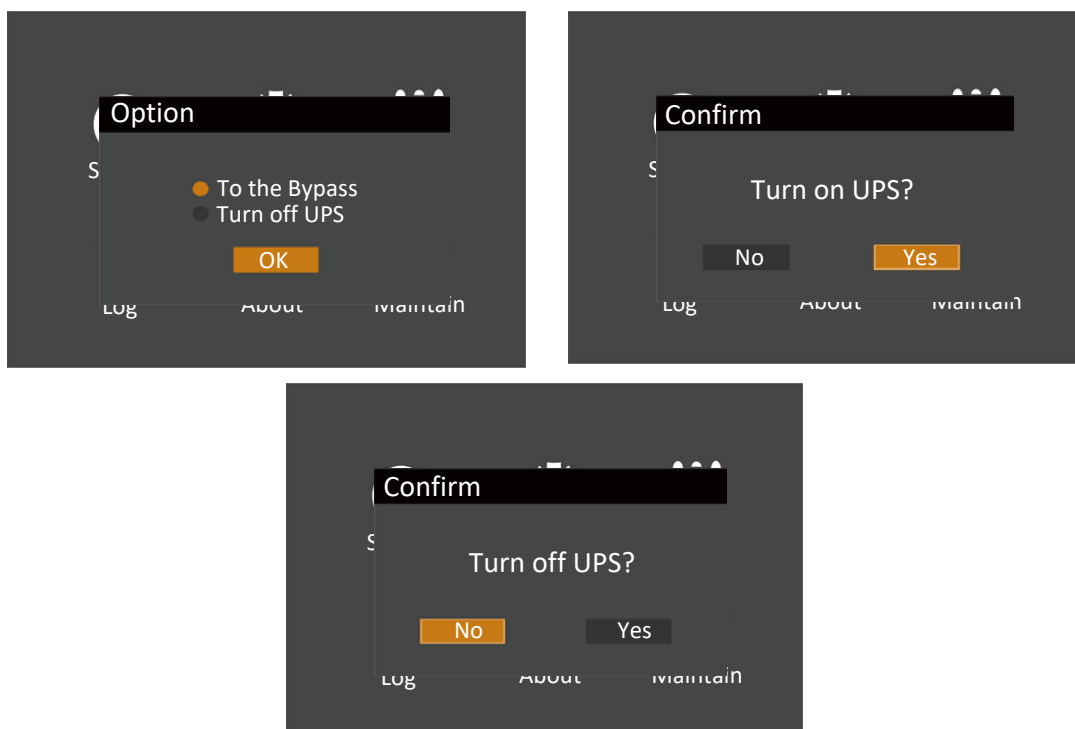

Figure 5-4 ECO mode not turned on

Select 'Turn on UPS' and click OK to transfer to the Inverter mode, see Figure 5-5.

Select 'Turn off UPS' and click OK to shut down the UPS output.

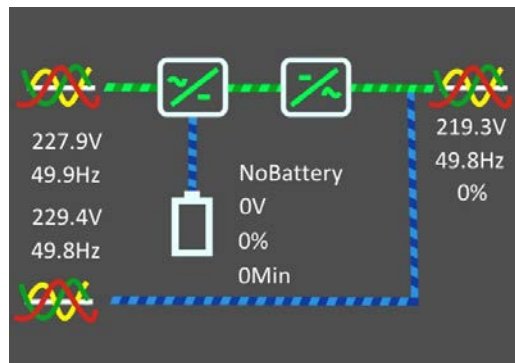

Figure 5-5 Bypass to inverter mode

If the ECO turned on, the interface shown in Figure 5-6 will appear. Select 'YES' to shut down the UPS output.

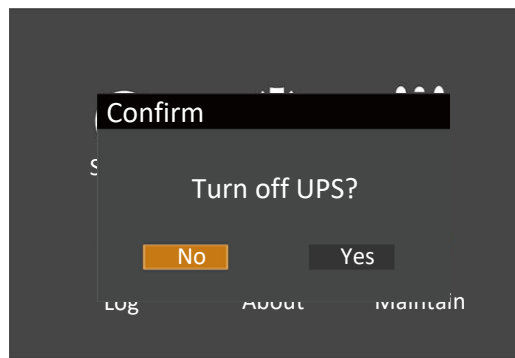

Figure 5-6 ECO turned on interface

5.2.4 Transfer From Inverter Mode To Maintenance Bypass Mode

When the UPS is running in Normal mode, you can use this procedure to make the load transfer from inverter output to maintenance bypass.



1. Before performing this procedure, you should check the LCD information first, and make sure the bypass is normal and synchronizes with the inverter. Otherwise, it may result in the load power interruption for a while.
2. To perform this function, user should select either a single POD or configure the MCB in maintenance bypass.

1. Through the LCD settings page, change the Dry connect 3 to 'Maintain mode'. See Figure 5-7.

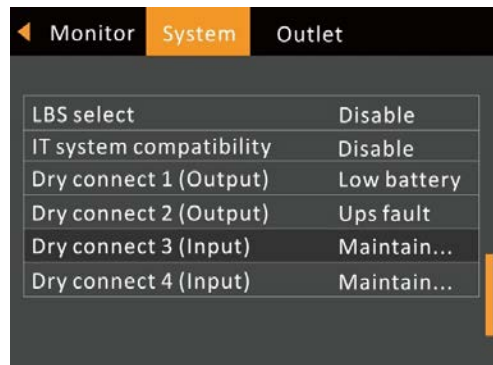

Figure 5-7 Changing dry contact 3 to 'Maintain mode'

2. Use the maintenance bypass signal cable (accessory of POD) to connect Dry Contact Port 3 of the UPS with interlock port on the POD. See Figure 5-8.

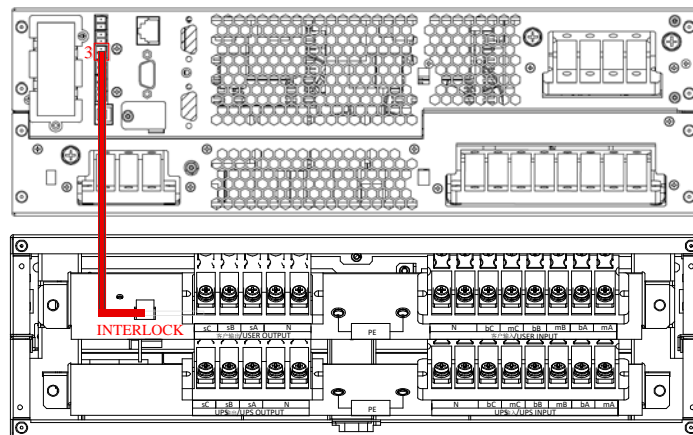

Figure 5-8 Ports connection

3. Remove the fixing screws of the baffle of the maintenance bypass switch, then rotate the baffle upwards till it is completely fixed, finally fasten the fixing screws.

At this time, the system Interlock function is activated, the UPS will transfer to internal bypass mode, and you should confirm that the UPS has been transferred to internal bypass mode.

4. After the confirmation, close the maintenance bypass switch.

5. Open the input MCB, maintenance bypass MCB and output MCB on the front panel of the POD. Perform the maintenance operation after the UPS complete shutdown.



Dry contact port 4 can achieve the same function as dry contact port 3 via the above steps.

5.2.5 Transfer From Maintenance Bypass Mode To Inverter Mode

After UPS maintenance, you can use this procedure to transfer the load from the maintenance bypass to the inverter.



If the user configures the maintenance bypass switch, the UPS must be manually transferred to the bypass mode after UPS maintenance and then close the output switch. Failure to observe this may cause damage to the equipment..

1. Confirm that the baffle of the maintenance bypass switch has been rotated upwards and firmly.
2. Close the mains input MCB and bypass input MCB on the front panel of the POD. At this time, the UPS will power on again and operate at bypass mode.
3. Confirm that the UPS has worked in Bypass mode, then close the output MCB on the front panel of the POD.
4. Open the maintenance bypass MCB on the front panel of the POD. Rotate the baffle of the maintenance bypass switch to its original position, then fasten the fixing screws.
5. Press the power button on the operation and display panel of the UPS, and the UPS transfers to Inverter mode.

5.2.6 Adding A Single Unit In Parallel System

Refer to *3.5 Commissioning Parallel System* for details.

5.3 UPS Complete Shutdown

For the UPS system with POD, if you need to shut down the UPS completely and make no effect on the use of the load during the UPS power-off, transfer the UPS from Inverter mode to Maintenance Bypass mode according to the procedures in *5.2.4 Transferring From Inverter Mode To Maintenance Bypass Mode*. If the power to the load is not needed, open the input MCB, maintenance bypass MCB and output MCB to shut down the UPS completely. For the system has been transferred to maintenance bypass system, just open the maintenance bypass MCB directly, as shown in Figure 5-9.

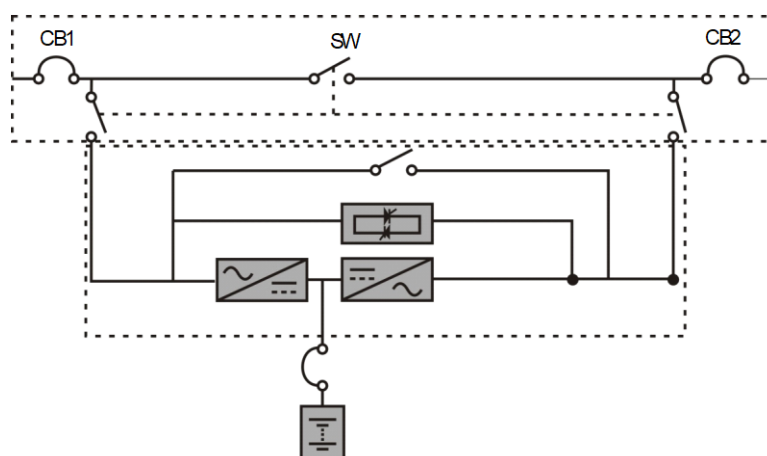

Figure 5-9 Configuration of the UPS with external maintenance bypass

For UPS system which the distribute power is accomplished by the user, if you need to isolate the UPS from AC power, disconnect the external input MCB. (If the main and bypass are independently powered, close the two input MCBs).



Cut off the maintenance power, in order to prevent the physical injury.

5.4 REPO

Located at rear of the UPS, the REPO port is designed to switch off the UPS in emergency conditions (such as fire, flood). The system will turn off the rectifier, inverter and stop powering the load immediately (inverter and bypass output included), and the battery stops charging or discharging. Just unplug the terminal connecting to the REPO if you need emergency power-off.

If the mains input is present, the UPS control circuit will remain active; however, the output is closed. To remove all mains power from the UPS, the external main input MCB should be disconnected.

5.5 Auto Restart

When the mains power failure, the UPS draws power from the battery to supply the load until the batteries are depleted, then the UPS will shut down.

The UPS will automatically restart and recover output power supply:



- After the mains power is restored.
- The UPS Auto Restart function is enabled.
- After the Auto Restart is delayed (default: 0s). During the Auto Restart delay, the UPS will charge the battery to provide a safety margin for equipment shutdown if input power fails again.

If the Auto Restart function is disabled, you can restart the UPS manually by pressing the power button.

5.6 Language Selection

The LCD menus are available in two languages: Chinese, English.

Procedures for selecting the language:

1. At the main menu screen, press the  or  key to switch the cursor to select 'Settings', then press the  key to confirm it. See Figure 5-10.

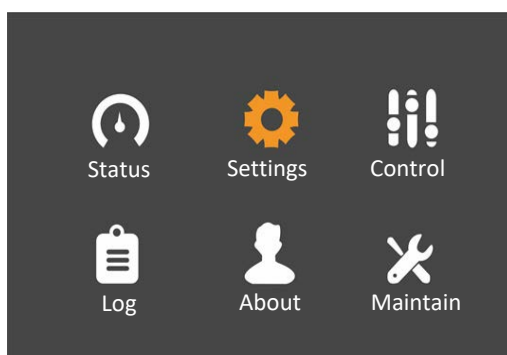



Figure 5-10 Main menu

2. Press the  key to move the cursor to 'Monitor', see Figure 5-11.

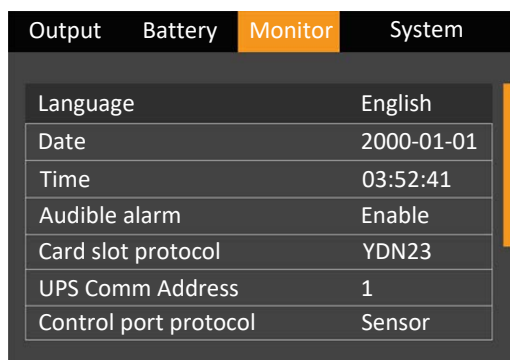





Figure 5-11 Monitor interface

3. Press the  key to highlight the language, see Figure 5-12.

Output	Battery	Monitor	System
Language	English		
Date	2000-01-01		
Time	03:52:41		
Audible alarm	Enable		
Card slot protocol	YDN23		
UPS Comm Address	1		
Control port protocol	Sensor		

Figure 5-12 Language selection

4. Press the  or  key to select the language you need, then press the  key to confirm it. At this time, the LCD contents will be the language selected by you. See Figure 5-13.

Output	Battery	Monitor	System
Language	English		
Date	2018-12-14		
Time	15:49:34		
Display orientation	Auto-rot...		
Audible alarm	Enable		
Intellislot	YDN23		
UPS Comm.Address	1		

Figure 5-13 Changing Language

5. Press the  key for several times to back to the main menu screen.

5.7 Changing Current Date And Time

Procedures for changing the system date and time:

1. At the main menu screen, press the or key to switch the cursor to select 'Settings', then press the key to confirm it. See Figure 5-14.

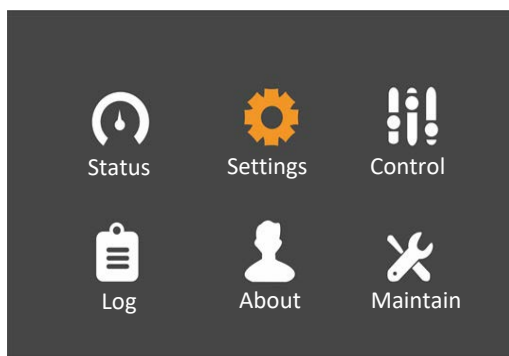

Figure 5-14 Main menu screen

2. Press the key to move the cursor to 'Monitor', see Figure 5-15.

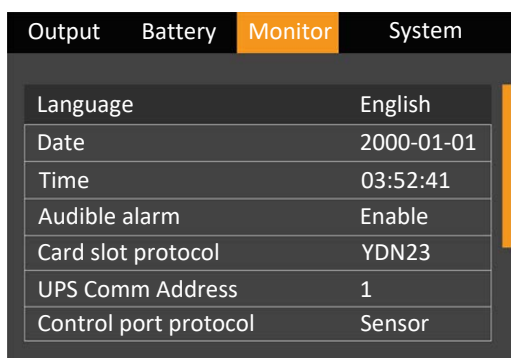

Figure 5-15 Monitor interface

3. Press the key, and press the or key to highlight the date and time, see Figure 5-16.

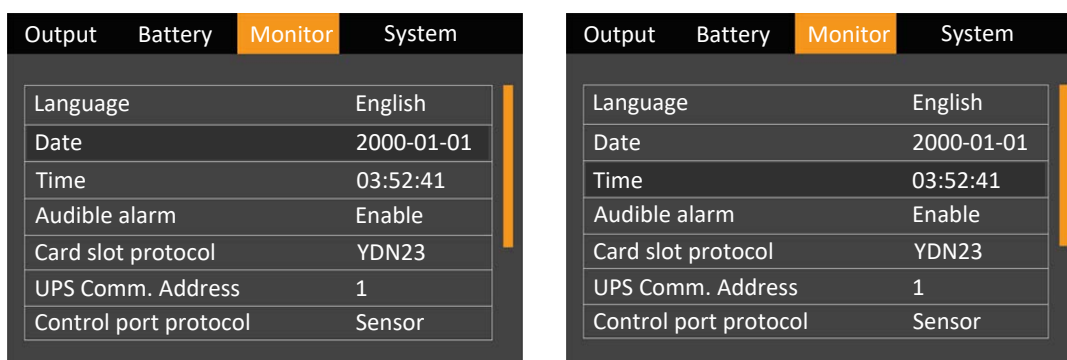

Figure 5-16 Selection of date and time

4. Press the **Enter** key, move the cursor and press the **▲** or **▼** key to change the date and time you need. See Figure 5-17.

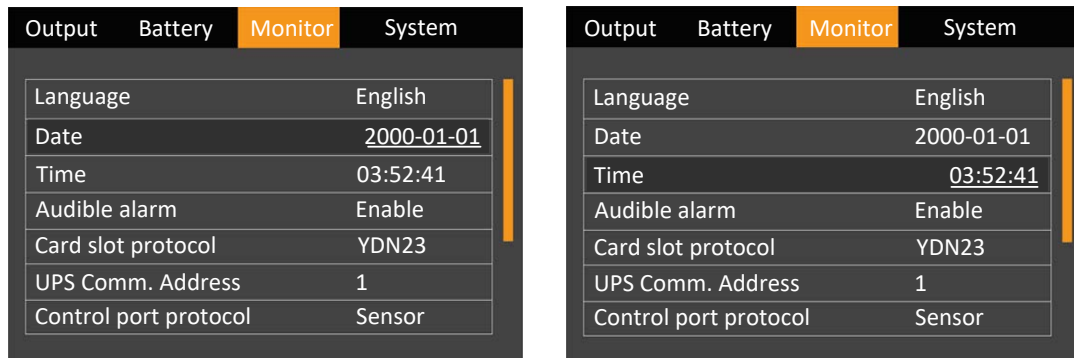

Figure 5-17 Changing date and time

5. Press the **Enter** key to confirm it, and then press the **Esc** key several times to back to the main menu screen.

5.8 Setting Password

1. After powering on the UPS, at the main menu screen, press the **▲** or **▼** key to move the cursor to select 'Settings'. See Figure 5-18.

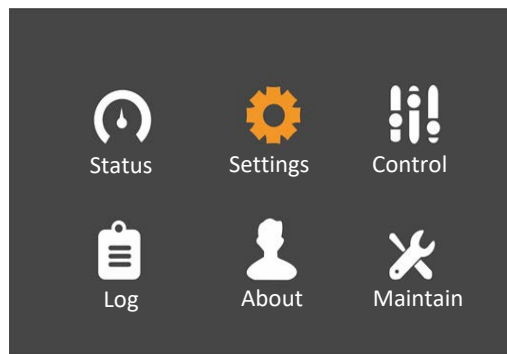

Figure 5-18 Main menu

2. Press the **Enter** key, the interface shown in Figure 5-19 will appear.

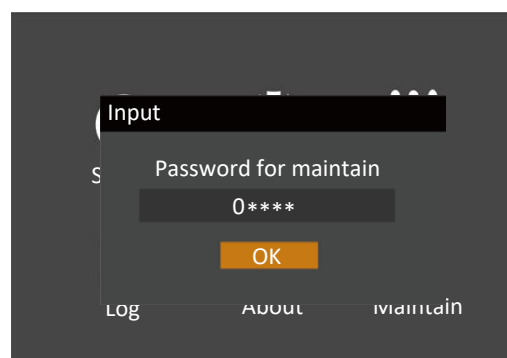



Figure 5-19 Inputting password

The user can observe the following procedures to change password:

1. Press the  key to move the cursor to the 'Monitor', see Figure 5-20.

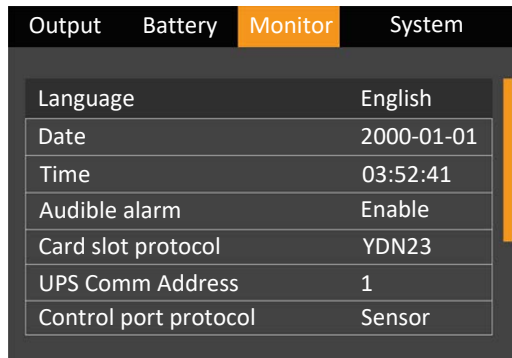



Figure 5-20 Monitor interface

2. Press the  key, then press the  key to select the 'Change settings password', see Figure 5-21.

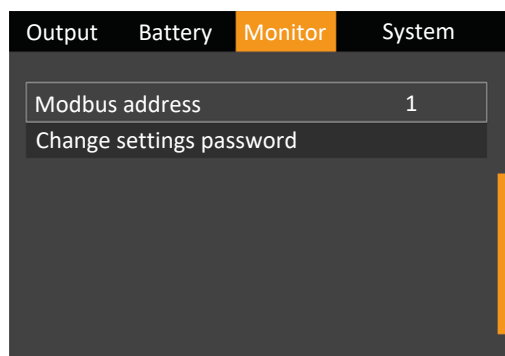



Figure 5-21 Changing settings password

3. Press the  key, the interface shown in Figure 5-22 will appear.

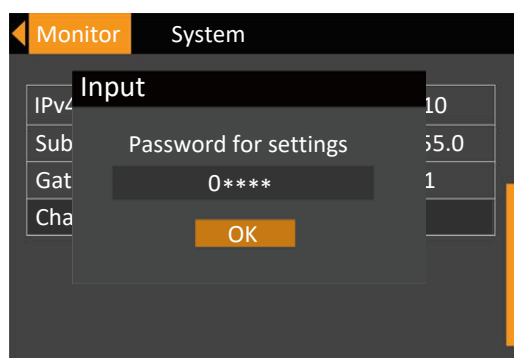

Figure 5-22 Password for settings

4. Input the existing password, press the key to confirm it, then the system requires to input a new password. See Figure 5-23.

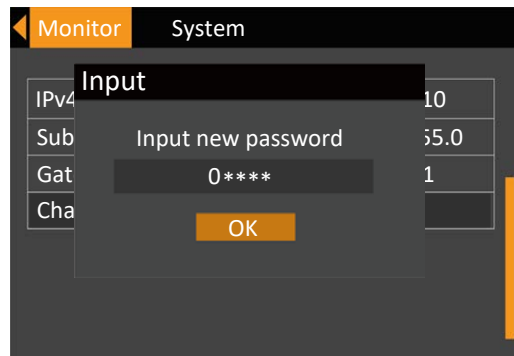

Figure 5-23 Inputting new password

5. After inputting the new password, press the key to confirm it, then the system requires to confirm the new password, see Figure 5-24.

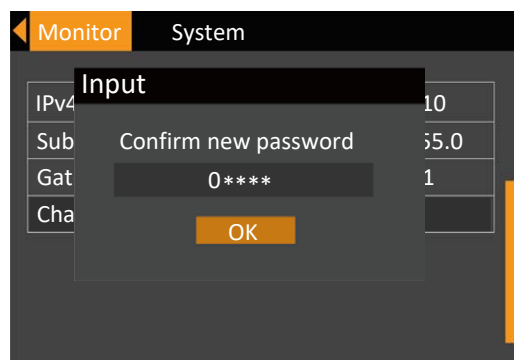

Figure 5-24 Confirming new password

6. After the confirmation, press the key and the system prompts that the password changing is successful, see Figure 5-25.

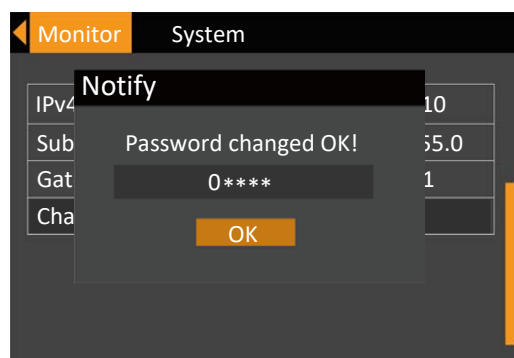

Figure 5-25 Password changed OK

7. Press the key for several times to back to the main menu screen.



Only through the correct password (default: 11111) verification can you conduct the parameters of the UPS.

6 Communication

This chapter briefly introduces the UPS communication.

The communication ports include: intelligent card port, dry contact port, built-in port, 232 port, control port and USB port.



It is recommended to make the signal cable length be less than 3m and keep away from the power cable.

6.1 Installing Intelligent Card

6.1.1 Intelligent Card Port

UPS provides an intelligent card port (see Figure 6-1), which is used to install the communication device options, including SIC card, RDU-SIC card, UNITY card, 485 card. The intelligent card port and USB port can be used at the same time.

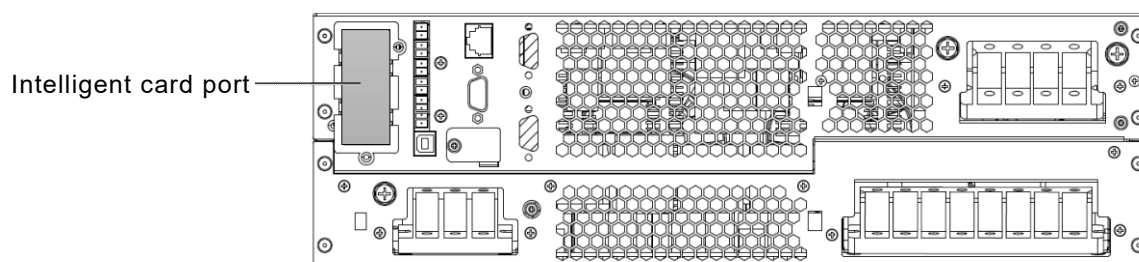

Figure 6-1 Intelligent card installation (rear view)

6.1.2 Intelligent Card Option

SIC card

SIC card is a network management card, which makes the intelligent devices (such as UPS, air conditioner, static transfer system (STS), server power management system (SPM), and so on) produced by Vertiv have network communication capability. The SIC card can also be used with the Network Shutdown designed by Vertiv to provide safe automatic shutdown function for the computer, in which the Network Shutdown has been installed, to protect data and reduce loss.

Refer to *the corresponding user manual* for the installation and operation guide.

RDU-SIC card

The RDU-SIC card is a network management card. It can make the intelligent equipment (such as UPS, PDU and so on) developed by Vertiv have the capacity of network communication. The SIC card can also connect to the environment monitoring equipment, including IRM series or 1-Wire series temperature sensor, temperature & humidity sensor or dry contact signal input & detecting sensors. In case of an intelligent equipment alarm, it notifies the user by multiple ways: recording, sending a Trap message, sending an E-Mail or sending an SMS.

The RDU-SIC card provides four approaches to monitor the intelligent equipment and equipment room environment:

- Web browser. Monitor your intelligent equipment and equipment room environment through the Web server function provided by the SIC card
- Network management system (NMS). Monitor your intelligent equipment and equipment room environment through the SNMP agent function provided by the SIC card
- RDU-Manager. RDU-Manager is a piece of management software for equipment room. You can use RDU-Manager to monitor your intelligent equipment and equipment room environment through the TCP/IP interface provided by the SIC card
- Centralized management software (Nform). Monitor your intelligent equipment through the Velocity Server service function provided by the SIC card

The SIC card can also work with the Network Shutdown computer safe shutdown program developed by Vertiv to provide automatic safe shutdown function for your computer installed with Network Shutdown, so as to prevent data loss.

Refer to *the corresponding user manual* for the installation and operation guide.

IS-UNITY-DP card



It is recommended to use the shielded cables to enhance the EMC.

The IS-UNITY-DP card should be used together with Liebert® ITA2 UPS provided by Vertiv.

For further description of the IS-UNITY-DP card, refer to *Liebert IntelliSlot™ Unity Card User Manual-Web, SNMP, Modbus, BACnet, YDN23*.

RELAY card

Provide the dry contacts alarm information, including: batteries, bypass, low battery, the alarm, fault and UPS signal, which is used to communicate with remote monitoring system or with Liebert MultiLink® software used together. Regardless of the current mode of operation, the card can also accept input signals to shut down the UPS.

Please refer to *the corresponding user manual* for installation and operation information.

6.2 Connection Cables For Dry Contact Port

The UPS provides five dry contact ports. The silkprints of the five dry contact ports are 1 ~ 12. The pin layout of each dry contact port is shown in Figure 6-2, and the port description is shown in Table 6-1.

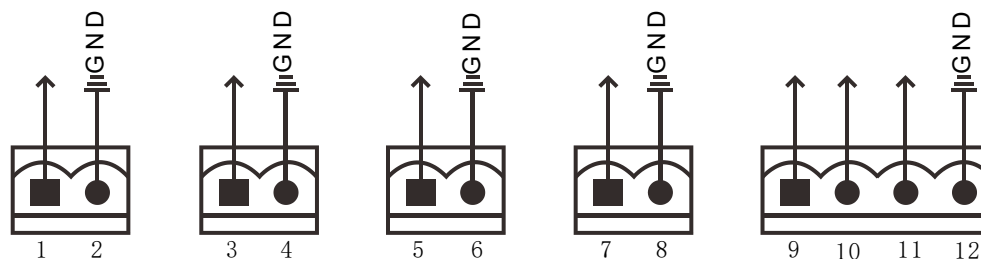

Figure 6-2 Pin layout of dry contact ports

Table 6-1 Description of the dry contact ports

Silkprint	Port name	Pin NO.	Pin name	Meaning
1	Output port1	1	LOW_BATTER/ON_BATTERY /ON_BYPASS/UPS_FAULT	Default: LOW_BATTER, can be set via the LCD settings page. When the system has as alarm, short Pin 1 and Pin 2
		2	GND	GND
2	Output port 2	3	LOW_BATTER/ON_BATTERY /ON_BYPASS/UPS_FAULT	Default: UPS_FAULT, can be set via the LCD settings page. When the system has as alarm, short Pin 3 and Pin 4
		4	GND	GND
3	Input port 1	5	Battery mode shutdown/Any mode shutdown (Remote Comms Shutdown)/ Maintain mode	Default: Maintain mode, can be set via the LCD settings page. When Pin 5 and Pin 6 are shorted, the function is valid
		6	GND	GND

Silkprint	Port name	Pin NO.	Pin name	Meaning
4	Input port 2	7	Battery mode shutdown/Any mode shutdown (Remote Comms Shutdown)/ Maintain mode	Default: Maintain mode, can be set via the LCD settings page. When Pin 7 and Pin 8 are shorted, the function is valid
		8	GND	GND
5	REPO input port*	9	+5V	REPO power supply, 5Vdc 100mA
		10	REPO Coil -NC	NC, ECO activated when Pin 9 and Pin 10 opened
		11	REPO Coil -NO	Trigger REPO when Pin 11 and Pin 12 closed
		12	GND	REPO ground



The I/O dry contact port capacity: 125Vdc, 0.5A; 30Vdc, 1A.

Pin11 and Pin12 reserves the corresponding terminals for configuring the REPO function. The REPO device also needs the shielded cable to connect to the Normally Open remote REPO switch between the two terminals. If not necessary, you should disconnect Pin9 and Pin10. Pin9 and Pin10 have been shorted before delivery.



The EPO action of the UPS will close the rectifier, inverter and static bypass, but it cannot disconnect the UPS mains input inside. If you want to disconnect the UPS completely, just disconnect the upstream input MCB when generating the EPO.

In emergency conditions, close the REPO switch (prepared by users) to shut down the rectifier and inverter, and the UPS is powered off. In normal condition, the REPO switch cannot cut off the UPS input power. If a switch of electronic control tripping function is adopted at the UPS input, the REPO switch can help the switch trip and thus cut off the UPS input power. The position of the REPO switch is shown in Figure 1-3, and the REPO cable connection is shown in Figure 6-3.

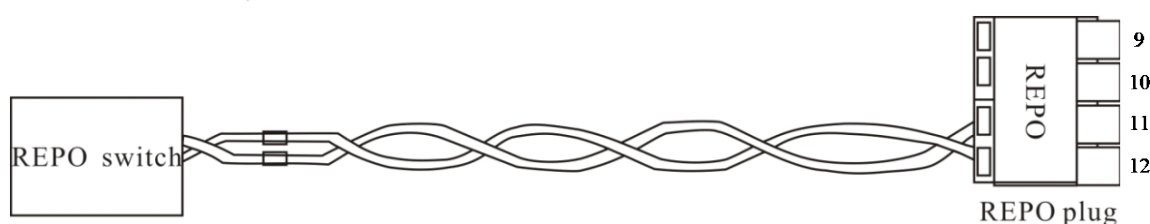

Figure 6-3 REPO cable connection

The cable connection procedures are as follows:

1. Loosen the '11' and '12' connection terminals of the REPO port.
2. Insert the two ends of the copper core cables with the insulation leather peeled into the '11' and '12' connection terminals of the REPO port, and press down the terminals. The REPO cable is complete. Ensure that the REPO cable is firmly connected to avoid no action or wrong action of the REPO caused by accidental dropping or infirm contact.

3. For parallel UPSs, when connecting the REPO cable, users should parallel connect '11' of the REPO port with one end of the electronic switch, and parallel connect '12' with the other end of the electronic switch.

When the REPO switch at the user end closes, the UPS will generate an alarm and cut off the output immediately, and the UPS will not return to the normal operation state automatically. At this point, you must change the REPO switch state, and power on the UPS manually.



1. It is recommended to use $0.82\text{mm}^2 \sim 0.33\text{mm}^2$ (signal cable of 18AWG ~ 33AWG) copper core cable.

2. If the switch you have configured is of electronic control tripping function, when the REPO signal takes action, you need to close the switch before restart the UPS.

6.3 Connecting USB Communication Cables

The methods to connect the USB communication cable are as follows:

Insert one end of the USB communication cable to the USB port (see Figure 1-3) on the rear panel of the UPS, and connect the other end to the USB port of the computer.

After the connection, you need to install the USB drive program in the installation disk.

6.4 Connecting Serial Port Communication Cables

The methods to connect the serial port communication cable are as follows:

Insert one end of the DB9 serial port communication cable to the DB9 serial port (see port 5 in Figure 1-3) on the rear panel of the UPS, and connect the other end to the DB9 port of the computer.

The pin function of DB9 is listed below:

Pin No.	Function
2	Send data
3	Receive data
5	Common terminal

6.5 Connecting Control Port

The control port adopts the standard RJ45 port, which supports the Modbus/Jbus port and connects the Vertiv temperature/temperature & humidity sensor.

The user can select Modbus/Jbus protocol function or sensor function via the 'Settings' on the LCD.

6.6 Connecting Built-in Ethernet Port

The built-in Ethernet port supports the HTTP protocol. The user can connect one end of the network cable to the Ethernet port of the UPS, and connect the other end to the built-in Ethernet port of the computer. The user can remotely access the UPS via the IE, Chrome and Firefox, so as to monitor the UPS in real time.

Connect network cables: Connect one end of the network cable to the Ethernet port of the UPS, and connect the other end to the built-in Ethernet port (or the switch port, Router port) of the computer.

Set network parameters: The user should change the parameters (IP address, subnet mask, gateway address) of the computer or the UPS, so as to make the computer communicate the UPS well.

To change the network parameters of the UPS, operate them via the 'Settings'->'Monitor', as shown in Figure 6-4.

Webpage monitoring function

Open the browser (like IE), input the IPv4 address at the address bar to the login interface. After inputting the correct user name and password (default name: user, password: 111111), you can monitor the UPS working status.

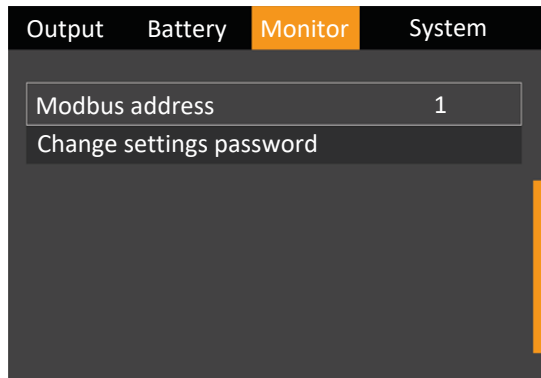

Figure 6-4 Changing UPS network parameters

Browser support

To obtain the best user experience, it is recommended to use the Internet Explorer (IE9 or above), or the Chrome, FireFox (latest version required)

Screen resolution

The display with resolution of 1024*768 or above is recommended.

7 Maintenance

This chapter focuses on the UPS maintenance, including the fan maintenance, battery maintenance, UPS cleaning, UPS state check, UPS function check.



Never attempt to carry out maintenance on the UPS while it is on line. Ensure that the UPS has been switched off completely when performing any internal maintenance operations on it.

7.1 Fan Maintenance



In order to avoid injury or damaging the device, wait until the fan is completely stationary before in-serting fingers or any tools into it.

The UPS fans are expected to run for 20000 hours ~ 40000 hours continuously. The higher the ambient temperature, the shorter the fan life is.

During the UPS operation, please verify the fan status once every half year by confirming that air blows out from the ventilation holes on the rear panel.

7.2 Battery Maintenance



*1. Never reverse-connect the battery connections, otherwise the fire will occur.
2. Never attempt to open batteries since they contain electrolyte which is potentially harmful to personnel. In the event of accidental with electrolyte, wash the affected area with abundant, clean water, and seek medical assistance immediately.*

The internal battery of the UPS is sealed, lead-acid, maintenance-free battery. The battery life depends on the ambient temperature, charge and discharge times. High ambient temperature and deep discharge shortens the battery life.

To ensure the battery life, it is required to:

- Keep the ambient temperature ranging from 15°C to 25°C
- Prevent small current discharge. Continuous battery operation time exceeding 24 hours is strictly prohibited
- Charge the battery for at least 12 hours, if the battery hasn't been charged for three months at specified ambient temperature, or two months at high ambient temperature



1. Check regularly the screws at the battery connection parts, fasten it immediately if not tight.
2. Make sure that the safety equipment are complete and that the function is normal, especially that the settings of the battery management parameters are normal.
3. Measure and record the internal temperature of the battery room.
4. Check whether the battery ports are damaged or hot, and whether the chassis and the covers are damaged.

If liquid leakage and damage to the battery are found, place the battery in the anti-vitriol tank, and deal with it according to the local regulations.

The waste lead-acid battery is dangerous waste material. It is one of the national emphases to control the waste battery pollution. Its storage, transportation, usage and disposal must follow the national and local law and other criterions about the dangerous waste material and the waste battery pollution prevention.

According to the related regulations, recycle the waste lead-acid battery, and other disposal methods are prohibited. Throwing away randomly the waste lead-acid battery and other improper disposal methods can result in serious environment pollution, which will be investigated the legal responsibility.

As the provider of the lead-acid battery, Vertiv has built perfect service network and recycle system for the waste battery to assist users to deal with the waste battery by law. Contact Vertiv or the nearest service center for the detailed information of the recycle system about the waste battery.

Vertiv is not liable for the environment results caused by failure to comply with the notices in this section or to use the waste battery recycle system provided by Vertiv.

7.3 Cleaning UPS

To ensure free airflow inside the UPS: Clean the UPS periodically, especially the ventilation holes. If necessary, clean the UPS with a vacuum cleaner. Confirm that the ventilation holes are unobstructed.

7.4 Checking UPS State

It is recommended to check the UPS operation status once every half year.

Check the following items:

1. Check if the UPS is faulty: Is the alarm indicator on? Are there any active UPS alarms?
2. Check if the UPS is operating in Bypass mode Under normal conditions, the UPS operates in Normal mode; if you find that it is operating in Bypass mode, determine the reason (operator intervention, overload, internal fault, etc.)

3. Check if the battery is discharging: If the AC mains supply is within normal limits, the battery should not be discharged; if you find that it is operating in Battery mode, determine the reason (mains failure, battery test, operator intervention, etc.).

7.5 Checking UPS Functions



UPS functions check procedures may cause power interruption to load!

It is recommended to check the UPS functions once every half year.

Backup the load data before conducting the UPS functions check. Procedures are as follows:

1. Press the power button to check if the buzzer beeps, indicators are ON and the LCD display is normal.
2. Press the ESC key to check again if the indicators are ON, the LCD display is normal and the UPS has been transferred to the inverter mode.

8 Options

This chapter introduces the options of the UPS.

8.1 Option List

See Table 8-1 for the option list.

Table 8-1 Option list

Option name	Model	Remark
POD	ITA-30k00POD01	Single POD (with maintenance bypass)
	ITA-30k00POD02	1 + 1 POD (1with maintenance bypass); 2+0 parallel system not available
Communication cables	ITA-20k00AL3A02C0 OL1	UPS parallel communication cables (1m)
	ITA-20k00AL3A02CL3	UPS parallel communication cables (3m)
Guide rail	GXT4-RMKIT1832	Guide rail for rack installation
Dual bus assembly	ITA-20k00AL3A02C0 OL2	LBS cables (1m)
	ITA-30k00AL3302CL1	LBS cables (5m)
	ITA-30k00AL3302CL2	LBS cables (10m)
Communication options	RDU-SIC	RDU SIC card is used for the Intellislot series UPS
	UF-SNMP810	SIC card is used for Intellislot series UPS
	IS-UNITY-DP	UNITY card is used for Intellislot series UPS
	IS-RELAY	RELAY card is used for Intellislot series UPS
Sensor	IRM-S01T	Intelligent temperature sensor
	IRM-S02TH	Intelligent temperature/humidity sensor

8.2 POD

POD (option of the UPS) can provide safe and reliable power distribution function. The descriptions of the POD are listed in Table 8-2.

Table 8-2 POD

Type	Name	Description
ITA-30k00POD01	Single POD (with maintenance bypass)	(W × D × H): 435mm × 500mm × 130mm
ITA-30k00POD02	1 + 1 POD (with maintenance bypass)	(W × D × H): 430mm × 500mm × 261mm

For the installation and commissioning of the POD, refer to *Liebert® ITA2™ 30kVA UPS Power Distribution Unit User Manual*.

Remove the plastic panel to reveal the POD front panel; remove the rear baffle plate to reveal the POD rear panel. The front panel and rear panel of the single POD are shown in Figure 8-1. The front panel and rear panel of the 1 + 1 parallel POD are shown in Figure 8-2.

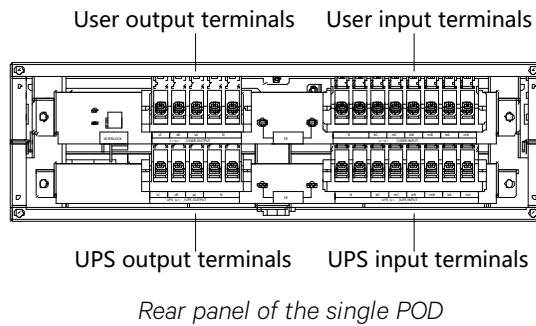
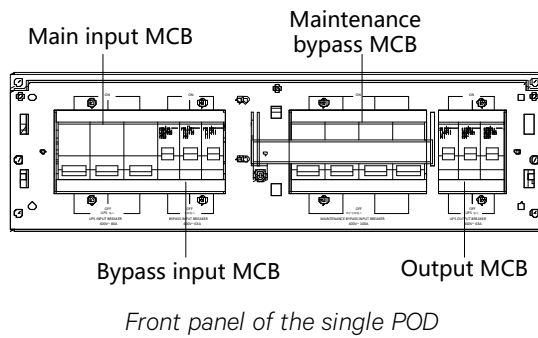

Figure 8-1 Front panel and rear panel of the single POD

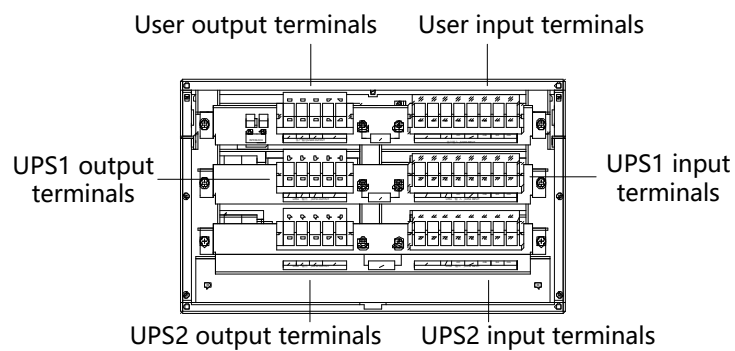
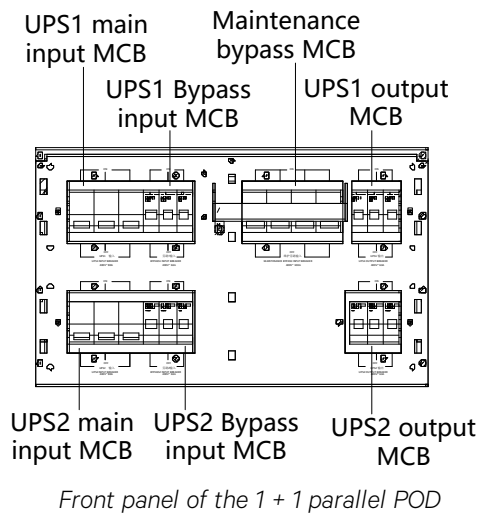



Figure 8-2 Front panel and rear panel of the 1 + 1 parallel POD

8.3 Communication Cables

Communication cable is compulsory in parallel system. See Table 8-3 for cable description. Refer to 3.4.2 *Connecting Parallel Cables* for the methods to connect the parallel cables.

Table 8-3 Description of the communication cable

Type	Name	Description	Appearance
ITA-20k00A L3A02COOL 1	Parallel communication cable	For N + 1 parallel system, N + 1 communication cables (1m) are needed. For example, two communication cables are needed in 1 + 1 parallel system; three communication cables are needed in 2 + 1 parallel system; four communication cables are needed in 3 + 1 parallel system	
ITA-20k00A L3A02CL3	Parallel communication cable	For N + 1 parallel system, N + 1 communication cables (3m) are needed. For example, two communication cables are needed in 1 + 1 parallel system; three communication cables are needed in 2 + 1 parallel system; four communication cables are needed in 3 + 1 parallel system	

8.4 Guide Rail

The guide rail is used in rack installation of UPS, POD (optional). The detailed description is listed in Table 8-4.

Table 8-4 Description of the guide rail

Type	Name	Description	Appearance
GXT4-RMKI T1832	Guide rail for rack installation	A set of guide rail includes a left guide rail and a right guide rail, and its bearing is 50kg. Use the guide rail in the rack installation. It is applicable to the various server cabinet, UPS, and POD	

For the rack mode installation procedure, refer to 2.5.2 *Rack Installation*.

8.5 Dual Bus Parts

The LBS cables are compulsory in dual bus system. See Table 8-5 for the dual bus parts.



Table 8-5 Dual bus parts



Type	Name	Description	Appearance
ITA-20k00A L3A02C00L 2	LBS cable	Be used to form LBS system (1m). Two LBS cables are recommended	
ITA-30k00A L3302CL1	LBS cable	Be used to form LBS system (5m). Two LBS cables are recommended	
ITA-30k00A L3302CL2	LBS cable	Be used to form LBS system (10m). Two LBS cables are recommended	

8.6 Communication Options And Temperature/Humidity Sensor

The communication options and the monitoring options are listed in Table 8-6.

Table 8-6 Communication options and the monitoring optios

Name	Type	Description	Appearance
SIC card	UF-SNMP810	Remote monitor UPS through TCP/IP protocol and Internet; Support remote safe shutdown; Provide an extended net port, cascade-connect up to eight temperature humidity sensors	
RDU SIC card	RDU-SIC	Be used to connect UPS to RDU-SIC monitoring unit, or connect to the cascade-communication in parallel system	
UNITY card	IS-UNTIY-DP	Unity card adopts Ethernet network to monitor and manage various operating parameters, alarms and notifications about power, distribution and cooling equipment. The card also communicates with the building management system and the network management system	

Name	Type	Description	Appearance
Relay acrd	IS-RELAY	<p>1. It can be connected to remote 4-route relay switch signal output: Low battery, On bypass, On battery, UPS fault. Each dry contact output includes a normally open and normally closed interface for user selection.</p> <p>2. The realy card can receive 3-route switch signal input, two of which control UPS startup and shutdown functions, and the third one is reserved</p>	
Intelligent Temperature sensor	IRM-S01T	With LCD screen, connects the SIC card or the multifunction port	
Temperature humidity sensor	RDU-A-S02TH	With LCD screen, connects the SIC card or the multifunction port	



When using the SIC card to connect to the temperature sensor as battery temperature compensation, connect to the COM1 port of the SIC card, and set DIP switch of the temperature sensor to '1'. For the installation and setting of the SIC card, refer to RDU-SIC Card User Manual.

Appendix 1 LCD Parameters Setting

Menu	Item	Setting range	Default setting	
System	Auto restart	Disable, Enable	Enable	
	Auto restart delay	0 ~ 999 seconds	0	
	Guaranteed shutdown	Disable, Enable	Disable	
	Remote control	Disable, Enable	Enable	
	Remote power on delay	0 ~ 999 seconds	0	
	Remote shutdown delay	0 ~ 999 seconds	0	
	LBS select	Disable, Master, Slave	Disable	
	IT system compatibility	Disable, Enable	Disable	
	Dry contact 1 (Output)	Low battery, On bypass, On battery, UPS fault	Low battery	
	Dry contact 2 (Output)	Low battery, On bypass, On battery, UPS fault	UPS fault	
	Dry contact 3 (Input)	Battery mode shutdown, Any mode shutdown, Maintain mode	Maintain mode	
	Dry contact 4 (Input)	Battery mode shutdown, Any mode shutdown, Maintain mode	Maintain mode	
Output	Voltage selection	220V, 230V, 240V	220V	
	Startup on bypass	Disable, Enable	Disable	
	Frequency selection	Auto, BypEna; Auto, BypDisa; 50Hz, BypDisa; 60Hz, BypDisa	Auto, BypEna	
	Inverter sync range	±0.5Hz, ±1.0Hz, ±2.0Hz, ±3.0Hz, ±4.0Hz, ±5.0Hz	±3.0Hz	
	Bypass voltage upper limit	+10%, +15%, +20%	+20%	
	Bypass voltage lower limit	-10%, -20%, -30%, -40%	-40%	
	Bypass frequency range	±5Hz, ±10Hz	±10Hz	
	Run mode	Normal, ECO mode	Normal	
	ECO voltage range	±5%, ±10%, ±15%	±10%	Appear only when the 'Run mode' is set to 'ECO mode'
	ECO frequency range	±1Hz, ±2Hz, ±3Hz	±3Hz	
	ECO requalification time	5, 15, 30 (min)	5	
Parallel	Voltage selection	220V, 230V, 240V	220V	
	Frequency selection	Auto, BypEna; Auto, BypDisa; 50Hz, BypDisa; 60Hz, BypDisa	Auto, BypEna	
	Run mode	Normal, ECO mode	Normal	
	Redundant	NO, YES	YES	
	System parallel No.	1 ~ 4	1	
	Sync parallel parameters	Button	Button	
Battery	Shared battery	Disable, Enable	Disable	
	Local/Parallel battery total Ah	7 ~ 3000Ah	18Ah	
	Low battery time	2 ~ 30 (min)	2	
	Battery test interval	Disable, 8 weeks, 12 weeks, 16 weeks, 20 weeks, 26 weeks	Disable	

Menu	Item	Setting range	Default setting
	Battery test weekday	Sunday, Monday, Tuesday, Wednesday, Thursday, Friday, Saturday	Wednesday
	Battery test time	MM:SS	00:00
	Battery series	32, 34, 36, 38, 40	32
	Discharge protect time	1 ~ 4320 (min)	4320
	Equal charge enable	NO, YES	NO
	Temperature compensation	Disable, Enable	Disable
	Replace battery	Button	Button
Monitor	Language	English, Chinese	English
	Date	YYYY-MM-DD	2000-01-01
	Time	HH:MM:SS	00:00:00
	Display orientation	Auto-rotate, Horizontal, Vertical	Auto-rotate
	Audible alarm	Enable, Disable	Enable
	Intellislot	Velocity, YDN23	Velocity
	UPS comm address	1 ~ 255	1
	Control port protocol	Modbus, Sensor	Sensor
	Modbus address	1~128	1
	IPv4 address	ddd.ddd.ddd.ddd ('d' is a decimal number)	192.168.1.10
	Subnet mask		255.255.255.0
	Gateway address		192.168.1.1
	SNMP NMS address		192.168.1.100
Change settings password	The password is numeric only and can be set from 0 to 9. The password length is 6	111111	

Appendix 2 Glossary

AC	Alternating current
CB	Circuit breaker
CSA	Cross sectional area
DC	Direct current
DIP	Dual in-line package
DSP	Digital signal processor
EMC	Electromagnetic compatibility
EMI	Electromagnetic interference
EOD	End-of-discharge
EPO	Emergency power off
I/O	Input/output
LBS	Load bus synchronizer
LCD	Liquid crystal display
LED	Light-emitting diode
MCB	Miniature circuit breaker
NMS	Network management system
PE	Protective earth
RCCB	Residual current circuit breaker
RCD	Residual current detector
REPO	Remote emergency power off
RFI	Radio frequency interference
SCR	Silicon-controlled rectifier
SNMP	Simple network monitoring protocol
STS	Static transfer switch
UPS	Uninterruptible power system

Appendix 3 Hazardous Substances And Content

Parts	Hazardous substances					
	Plumbum	Hydrargyru	Cadmium	Chrome ⁶⁺	PBB	PBDE
	(Pb)	(Hg)	(Cd)	(Cr (VI))	(PBB)	(PBDE)
Cables	×	○	○	○	○	○
<p>This table is made following the regulation of SJ/T 11364.</p> <p>○: Means the content of the hazardous substances in all the average quality materials of the parts is within the limits specified in GB/T 26572</p> <p>×: Means the content of the hazardous substances in at least one of the average quality materials of the parts is outside the limits specified in GB/T 26572</p>						
Applicable scope: Liebert® ITA2™ 30kVA UPS						



Vertiv.com | Asia-Pacific

© 2019 Vertiv Co. All rights reserved. Vertiv and the Vertiv logo are trademarks or registered trademarks of Vertiv Co. All other names and logos referred to are trade names, trademarks or registered trademarks of their respective owners. While every precaution has been taken to ensure accuracy and completeness herein, Vertiv Co. assumes no responsibility, and disclaims all liability, for damages resulting from use of this information or for any errors or omissions. Specifications are subject to change without notice.