



# Liebert<sup>®</sup> LDMF Distribution Monitoring

**User Manual**

The information contained in this document is subject to change without notice and may not be suitable for all applications. While every precaution has been taken to ensure the accuracy and completeness of this document, Vertiv assumes no responsibility and disclaims all liability for damages result from use of this information or for any errors or omissions.

Refer to local regulations and building codes relating to the application, installation, and operation of this product. The consulting engineer, installer, and/or end user is responsible for compliance with all applicable laws and regulations relation to the application, installation, and operation of this product.

The products covered by this instruction manual are manufactured and/or sold by Vertiv. This document is the property of Vertiv and contains confidential and proprietary information owned by Vertiv. Any copying, use, or disclosure of it without the written permission of Vertiv is strictly prohibited.

Names of companies and products are trademarks or registered trademarks of the respective companies. Any questions regarding usage of trademark names should be directed to the original manufacturer.

### **Technical Support Site**

If you encounter any installation or operational issues with your product, check the pertinent section of this manual to see if the issue can be resolved by following outlined procedures.

Visit <https://www.vertiv.com/en-us/support/> for additional assistance.

# TABLE OF CONTENTS

<b>1 Important and Safety Instructions</b> .....	<b>1</b>
1.1 Electromagnetic Compatibility .....	1
<b>2 Product Overview</b> .....	<b>3</b>
<b>3 Major Components</b> .....	<b>5</b>
3.1 PM4 Monitor Board (PMB) .....	5
3.2 PM4 Interface Board (PIB) .....	5
3.3 PM4 Large Interface Board (PLIB) .....	7
3.4 Branch Circuit Monitoring Sensor Module (BSM) .....	7
3.5 Power Supply with EMI Filter .....	8
3.6 Human-Machine Interface Display Assembly (Optional) .....	9
3.6.1 Legacy Display Assembly .....	10
3.6.2 Current Display Assembly .....	10
3.7 PM4 Adapter Board .....	10
<b>4 Installation</b> .....	<b>13</b>
4.1 Installing a BSM (CT Module Assembly) .....	13
4.1.1 Connecting Panelboards A and B .....	14
4.2 Installing a Solid-Core Current Transformer .....	15
4.3 Installing a Current Transformer on the PIB Interface Board .....	16
4.4 Connecting a Current Transformer to the PM4 Large Interface Board (PLIB) .....	19
<b>5 Operation</b> .....	<b>23</b>
5.1 Alarms .....	24
5.2 Communication .....	25
5.2.1 LDMF Setup Port Connection .....	25
5.2.2 Modbus Connection .....	25
5.3 Downloading the Software .....	26
5.4 Using the Monitor Tool (Used Only for Startup and Diagnostics) .....	27
5.4.1 Starting the Monitor Tool .....	27
5.4.2 Monitor Menu Options .....	28
5.4.3 Panel Status and Real-Time Clock .....	28
5.4.4 Main Breaker Status .....	29
5.4.5 Breaker Status .....	29
5.4.6 Mode Buttons .....	30
5.5 Using the Configuration Tool .....	31
5.5.1 Starting the Configuration Program .....	31
5.5.2 Main Configuration Window Overview .....	32
5.5.3 Load a Configuration File from Disk .....	35
5.5.4 Install Configuration Changes in the Unit .....	35
5.5.5 Save the Configuration File to Disk .....	36

- 5.5.6 Select Panel to View ..... 37
- 5.5.7 Select Breakers to View ..... 38
- 5.5.8 Edit the Vertiv™ Liebert® LDMF Unit Properties ..... 38
- 5.5.9 Edit the Panel Properties or Set a Password ..... 39
- 5.5.10 Edit the Breaker Properties ..... 39
- 5.5.11 Add a Circuit Breaker ..... 41
- 5.5.12 Adding a Subfeed Breaker ..... 43
- 5.5.13 Delete a Circuit Breaker Subfeed Breaker ..... 45
- 5.6 Upgrading the Firmware ..... 46
- 5.7 Display Controls (Legacy HMI) ..... 52
  - 5.7.1 Controls and Indicators ..... 52
  - 5.7.2 Vertiv™ Liebert® LDMF Parameter Screens ..... 53
  - 5.7.3 Vertiv™ Liebert® LDMF Alarms ..... 54
  - 5.7.4 Vertiv™ Liebert® LDMF Screens ..... 56
- 5.8 Display and Controls (Current HMI) ..... 60
  - 5.8.1 Touchscreen Control Panel and User Interface ..... 60
  - 5.8.2 Restrict Physical Access with Barriers or Set Login Codes ..... 63
  - 5.8.3 Choose a Theme ..... 65
  - 5.8.4 Setting Display Properties ..... 66
  - 5.8.5 Change the Time Zone ..... 67
  - 5.8.6 Changing Date, Time and Measurement Formats ..... 67
  - 5.8.7 Change the Measurement System ..... 67
  - 5.8.8 Log In to the Touchscreen Control Panel ..... 68
  - 5.8.9 Context Menu Controls ..... 70
  - 5.8.10 Context Menu Commands for Administrators ..... 71
  - 5.8.11 View or Change Network Settings ..... 72
  - 5.8.12 View System Status ..... 73
  - 5.8.13 View Component Status with One-Line Diagram Links ..... 74
  - 5.8.14 Reset and Silence Faults and Events ..... 78
- 6 Specifications ..... 81**
- 7 Troubleshooting or Frequently Asked Questions ..... 83**
- 8 Glossary of Abbreviations ..... 85**

# 1 Important and Safety Instructions



**WARNING!** As with all types of electrical equipment, dangerous voltages exist within the equipment where the Vertiv™ Liebert® LDMF Distribution Monitor components are installed. For maximum safety, ensure power is removed and circuit breakers/disconnects are tagged/locked out per all applicable national, state and local electrical codes prior to working inside equipment.

The area around the equipment must be free of any debris or standing water. All power and control wiring must be installed by a qualified electrician in accordance with the NEC and all applicable national, state and local codes.

**ONLY** qualified service personnel should perform maintenance and/or service on the Liebert® LDMF system. When performing maintenance and/or service on any component, verify test equipment is insulated and has been inspected prior to use.

To avoid damage to the circuit boards, personnel handling these components should be wearing an electrostatic discharge strap or other approved protective device.

When replacing or installing a solid core Current Transformer (CT), power must be removed from equipment to prevent damage to the CT and/or circuit board. If the CT is a split-core design, follow proper electrical safety procedures and ensure the CT wires are connected to the applicable burdening circuit before attaching the CT around the conductor.

These safety precautions are to be used in conjunction with NEC and local/state electrical code.

## 1.1 Electromagnetic Compatibility

The Liebert® LDMF as a functional component of a power distribution and supply product complies with the limits for a Class A Digital Device, pursuant to Part 15 of FCC rules. Operation is subject to the following two conditions:

- This device must not cause harmful interference, and
- This device must accept any interference received, including interference that may cause undesired operation.

Operating this device in a residential area is likely to cause harmful interference that users must correct at their own expense.

Liebert® LDMF as a functional component of a power distribution and supply product complies with the requirements of EMC Directive 2004/108/EC and the published technical standards. Continued compliance requires installation in accordance with these instructions and use of accessories approved by Vertiv.

This page intentionally left blank

## 2 Product Overview

The Vertiv™ Liebert® LDMF monitors the main panelboard circuit breaker and individual panelboard branch circuit breakers. The measurements are used to report the voltage, current and alarm conditions for each breaker. The Liebert® LDMF utilizes branch circuit sensor modules and individual current transformers (CT) to monitor current. In addition, the Liebert® LDMF monitors options like subfeed and output circuit breakers and provides a full array of power parameters and alarms.

The Liebert® LDMF is available as an option for the Vertiv™ Liebert® PPC, Vertiv™ Liebert® FDC, Vertiv™ Liebert® FPC, Vertiv™ Liebert® RX and Vertiv™ Liebert® RDC.

The Liebert LDMF system can communicate with a Building Management System (BMS) and Vertiv™ Liebert® SiteScan™ Web via optional Vertiv™ Liebert® IntelliSlot™ cards or Vertiv™ Liebert® SiteLink interface. The Liebert® LDMF consists of a monitor board, interface board, optional local display and, Branch Sensor Modules (BSM).

The Liebert® LDMF is capable of receiving input from current branch sensor modules. BSM contains 100 A Current Transformers (CTs) encapsulated in an epoxy-filled plastic enclosure designed to be mounted next to the panelboard. Sensor modules are designed to work 3/4 in. or 1 in. spaced panelboards. If a sensor module CT fails, connections are provided for up to six replacement CTs. The optional CTs can be attached directly to the load cable feeding the failed CT.

Higher-rated CTs may be used for monitoring optional subfeed circuit breakers. For subfeed breakers, such as main panelboard breakers, the Liebert® LDMF monitors not only the 3-phase current but also the ground and neutral current. These subfeed circuit breakers are in addition to the panelboard circuit breakers that can be monitored through the BSM. The Liebert® LDMF can accommodate 18 individual large current transformers.

If your Liebert power center is supplied with a Square D™ I-Line™ panelboard, the Liebert® LDMF can monitor it as well as its output breakers. A PM4 Large Interface Board (PLIB) replaces the panelboard PM4 Interface Board (PIB) and can monitor up to 42 CTs. Each PLIB can monitor eight four-wire or five-wire I-Line and/or subfeed breakers including ground and neutral current. There are two (2) PLIBs per monitor board that can monitor up to 16 five-wire I-Line and/or subfeed breakers.

The Liebert® LDMF system includes three Liebert® IntelliSlot™ ports for remote communication. Optional Liebert® IntelliSlot™ cards can provide the following remote communications:

- IS-WEBS card for SNMP/WEB with RJ-45 connection to Ethernet LAN.
- IS-485S card for Modbus 485, 2-wire connection.
- IS-IPBMS card for Modbus IP, with RJ-45 connection to Ethernet LAN.
- IS-UNITY-DP card for HTTP/HTTPS, Vertiv Protocol, e-mail, SMS, SNMP v1/v2c/v3, BACnet IP/MSTP and Modbus TCP/RTU output using a serial RS-485 two-wire connection.

In addition to Liebert® LDMF remote communications, an optional local display offers easy-to-use viewing of electrical data for various branch breakers as well as alarm details such as the type and source of each alarm.

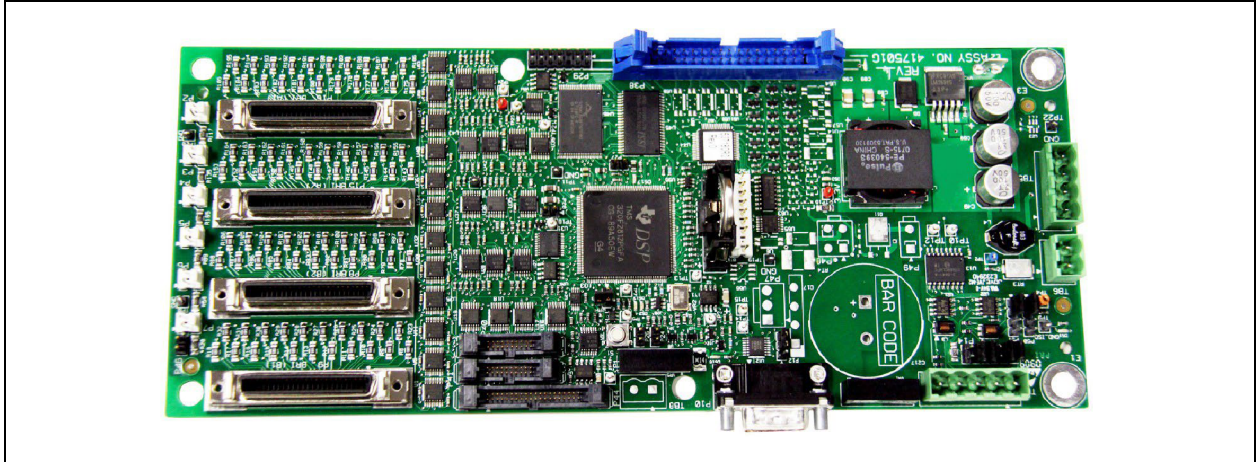
This page intentionally left blank



## 3 Major Components

### 3.1 PM4 Monitor Board (PMB)

Figure 3.1 PM4 Monitor Board (PMB)



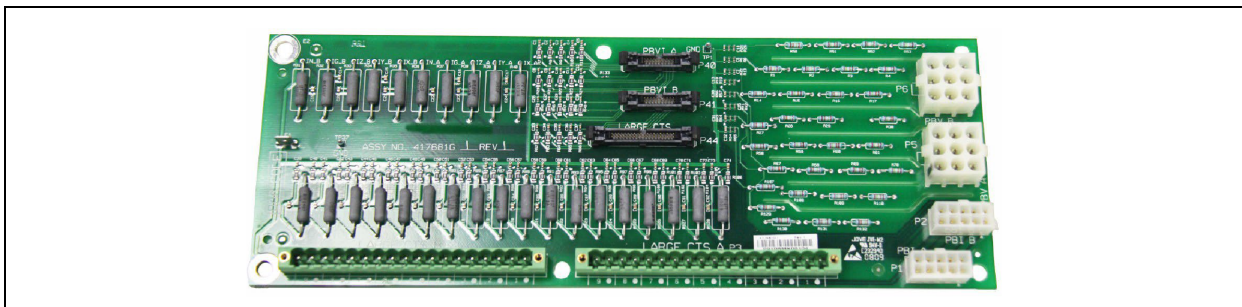
The PM4 Monitor Board (PMB) is the main processing and storage circuit board. The PMB contains the non-volatile memory where the configuration file is stored. The CT Module Assemblies will connect directly to the PMB via the 4 ribbon cables connectors. The PMB is a DSP-based logic controller with internal flash memory to store breaker configuration, alarms and energy data. The on-board battery supplies power to the real-time clock. All the electrical parameters are accumulated on the PMB for processing to Liebert Velocity protocol for remote monitoring and the HMI interface for the local display. Kilowatt-hours (kWh) data is accumulated on this board for the panelboard mains, subfeeds and each branch circuit breaker. A remote command can be used to reset the accumulated energy data.

Additional PMB Capabilities:

- Six (6) auxiliary CT connectors, which allow for replacing a failed CT.
- A DB9 serial port on the outside panel is available for local configuration.

### 3.2 PM4 Interface Board (PIB)

Figure 3.2 PM4 Interface Board (PIB)



The Vertiv™ Liebert® LDMF PM4 Interface Board (PIB) provides connections for the voltage and currents of the panelboard main circuit breaker as well as the CT current for any installed large branches or subfeed breakers (maximum of 18 CTs).

For the large branches or subfeed breakers, the nine CTs on the A side of the board are normally associated with the A-side voltages for power calculations. The B-side CTs are normally associated with the B-side voltages. A cross-configuration tool allows changing that association for subfeeds.

The 18 large branch CT inputs can also be used to monitor up to three subfeed circuit breakers. This is configured using the configuration tool (See [Using the Configuration Tool](#) on page 31). The CTs from the B side of the PIB are cross-configured to the A side so that the three subfeeds appear within the A-side panelboard register space. The 18 large branch breakers require CT's with 1 A secondary.



**WARNING! Before connecting a large CT to the PIB, note the CT MUST have a 1 A secondary. Connecting anything other than a 1 A secondary CT will damage the PIB and the CT.**

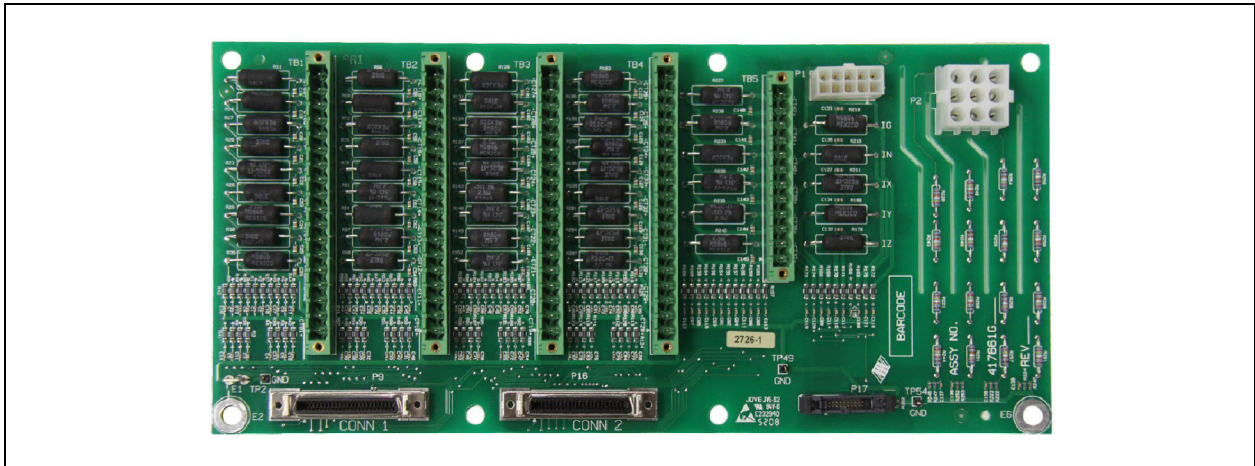
**To ensure the proper current ratio and accuracy, the CTs should be purchased through Vertiv. See [Table 3.1](#) below for details. Contact your local Vertiv representative or call Vertiv Support at 800-543-2378.**

**Table 3.1 CT Matrix for the Vertiv™ Liebert® LDMF**

Part Number	Description	Phase CT	Ground CT	Neutral CT
539217G1-L	3-pole 0-100 A subfeed breaker 5 W CT kit	200:1	100:1	200:1
539217G2-L	3-pole 125-225 A subfeed breaker 5 W CT kit	500:1	100:1	500:1
539217G3-L	3-pole 250-400 A subfeed breaker 5 W CT kit	1000:1	100:1	1000:1
539217G12-L	3-pole 125-225 A subfeed breaker 4 W CT kit	500:1	—	500:1
539217G13-L	3-pole 250-400 A subfeed breaker 4 W CT kit	1000:1	—	1000:1
539217G4-L	3-pole 0-100 A I-line breaker 3 W CT kit 47 in. frame	200:1	—	—
539217G5-L	3-pole 125-225 A I-line breaker 3 W CT kit 47 in. frame	500:1	—	—
539217G6-L	3-pole 250-400 A I-line breaker 3 W CT kit 47 in. frame	1000:1	—	—
539217G7-L	1-pole 0-100 A branch breaker CT kit	200:1	—	—

### 3.3 PM4 Large Interface Board (PLIB)

Figure 3.3 PM4 Large Interface Board (PLIB)



The PM4 Large Interface Board (PLIB) provides voltage and current attenuation for Square-D I-Line panelboards. There are 42 CT locations on each LIB for a total capacity of eight 4-wire (3 phases and neutral) or 5-wire (3 phases, neutral and ground) breakers.



**WARNING!** Before connecting a large CT to the PLIB, note the CT **MUST** have a 1 A secondary. Connecting anything other than a 1 A secondary CT will damage the PLIB and the CT. To ensure the proper current ratio and accuracy, the CTs should be purchased through Vertiv. See **Table 3.1** on the previous page for details. Contact your local Vertiv representative or call Vertiv Support at 800-543-2378. Two PLIBs are supplied for a total maximum monitoring capacity of sixteen 5-wire I-Line and/or subfeed breakers.

### 3.4 Branch Circuit Monitoring Sensor Module (BSM)

The Branch Circuit Monitoring Sensor Module (BSM)—more commonly referred to as the CT Module—contain 21, 27 or 36 individual Current Transformers filled inside an epoxy enclosure. Each load circuit is passed through one of the openings for branch circuit current monitoring. The signals leave the CT module via a ribbon cable which is connected directly to the PM4 Monitor Board (PMB) for attenuation and processing.

There are two BSM designs depending on the manufacturer of the panelboard installed:

- Utilize 1 in. spacing between circuits.
- Utilize 3/4 in. spacing between circuits.

Figure 3.4 Branch Circuit Monitoring Sensor Module (BSM)

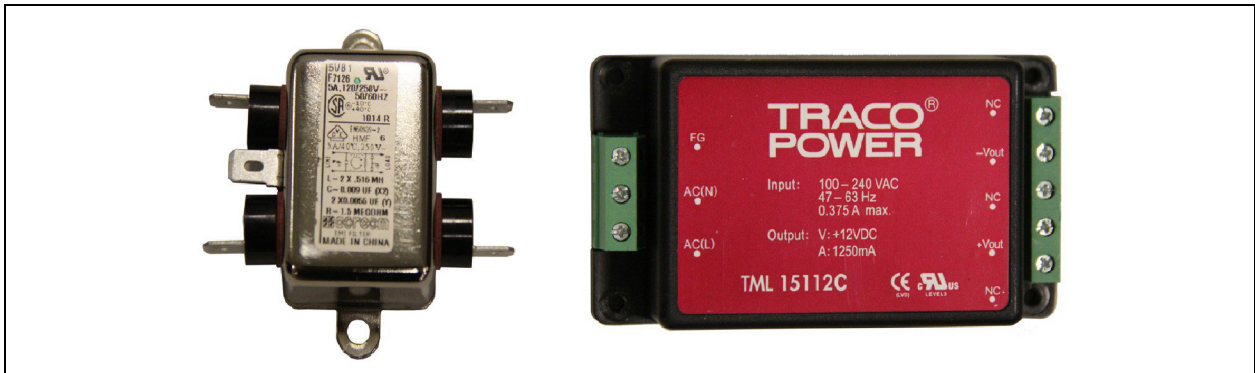


**NOTE:** The diameter of each CT hole is 0.433 in. (11 mm). Wire diameter and thickness of insulation must be taken into account before wiring each branch circuit. Using wire that is too large may prevent the conductor from fitting through the CT hole. Do not attempt to alter the diameter of the CT opening.

For larger panelboards, the CT Module is designed to interlock to maintain alignment between the breaker poles and the CT Modules.

### 3.5 Power Supply with EMI Filter

Figure 3.5 Power Supply with EMI Filter

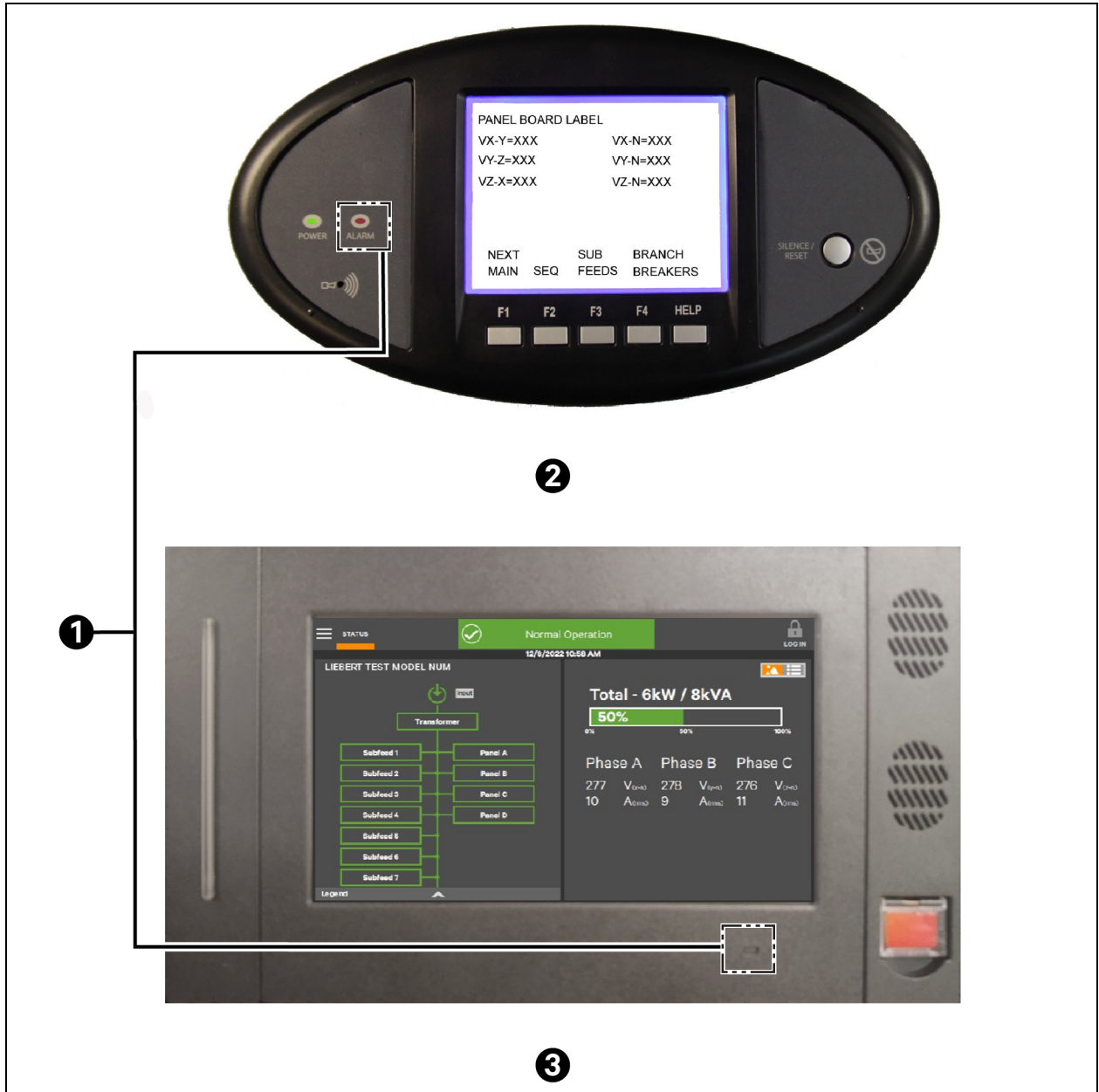


The power supply assembly converts 100-240 VAC (+10%/-13% range) 50/60 Hz into 12 VDC to provide logic level power for the PMB.

The Power Supply is fed from the line side of the panelboard main breaker. If during normal operation the panelboard main breaker trips or is turned off, the PMB will still have power to communicate alarms via the local display or remotely via Vertiv™ Liebert® IntelliSlot™ cards.

### 3.6 Human-Machine Interface Display Assembly (Optional)

Figure 3.6 Human-Machine Interface Display Assembly (Optional)



Item	Description
1	Alarm indicator LED
2	Legacy HMI
3	Current HMI

The LDMF allows users to view the panelboard circuit data locally through the optional display.

### 3.6.1 Legacy Display Assembly

The user interface has function keys to scroll through and view each panelboard's data as well as the associated branch circuits and/or subfeeds.

Along with the branch circuit data the LDMF Display also has an alarm annunciation window that lists all active alarms. The display has an LED status indicator that changes to red in the event of an alarm. The Silence/Reset button will silence the audible alarm when pressed once and held until alarm is silenced. When pressed a second time, the button clears the alarm and turns off the red LED.

Alarm thresholds cannot be added, deleted or adjusted on the local display. These functions may be performed only by using the LDMF Configuration software, which is available for download at the Liebert Web site. Refer to [Downloading the Software](#) on page 26 for downloading instructions and see [Using the Configuration Tool](#) on page 31 for details on using the software.

### 3.6.2 Current Display Assembly

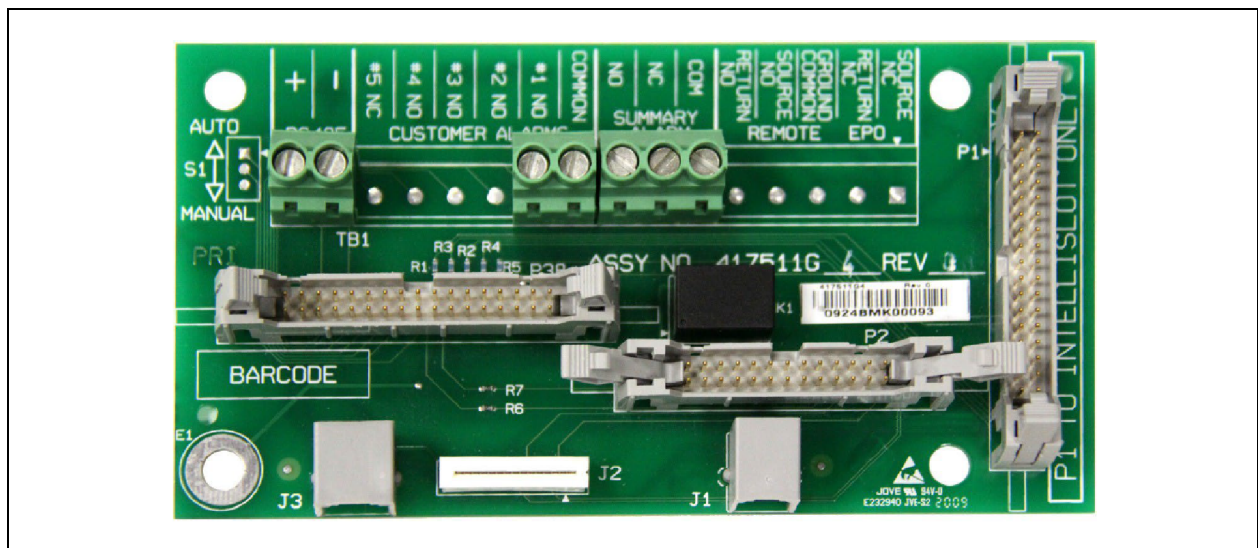
The user interface has a touchscreen interface to allow the user to view each panelboard's data as well as the associated branch circuits and/or subfeeds.

Along with the branch circuit data, the LDMF Display also has an alarm annunciation banner, and when that banner is pressed, a list of all active alarms is displayed. The display also has an LED status indicator that changes from green to red in the event of an alarm. The active alarms page has a Silence button that will silence the audible alarm when pressed, as well as a Reset Fault button for clearing the active alarms.

Alarm thresholds cannot be added, deleted or adjusted on the local display. These functions may be performed only by using the LDMF Configuration software, which is available for download at the Liebert Web site. Refer to [Downloading the Software](#) on page 26 for downloading instructions and see [Using the Configuration Tool](#) on page 31 for details on using the software.

## 3.7 PM4 Adapter Board

Figure 3.7 PM4 Adapter Board



- The PM4 Adapter Board (PAB) is provided with each Vertiv™ Liebert® LDMF. The PAB is typically mounted on the back of the display, which is located on the front door of the unit. The PAB provides a customer interface to the LDMF summary alarm contacts.

- If two Vertiv™ Liebert® LDMF systems are provided, the two PABs are connected to each other at the factory. It is only necessary to connect to one PAB to monitor the Customer Summary Alarm; the two Liebert® LDMF units share summary alarm contacts.
- On the Vertiv™ Liebert® FPC and Vertiv™ Liebert® PPC the PAB has additional connections on TB1 that include Remote Emergency Power Off (EPO). The field-selectable switch S1 on the PAB allows the selection for either Manual or Auto restart. The factory default setting is Manual.
- Manual restart allows for an orderly supervised startup after power failure. The control circuit automatically energizes the shunt trip mechanism of the main input breaker upon sensing output voltage failure.
- Setting the switch to Auto deactivates the manual restart. In Auto restart mode, the main input breaker does not trip due to power failure and the unit will restart when power is restored.

**NOTE: The TB1 connections for customer alarms 1-5 are used only with the VPMP product.**

This page intentionally left blank



## 4 Installation

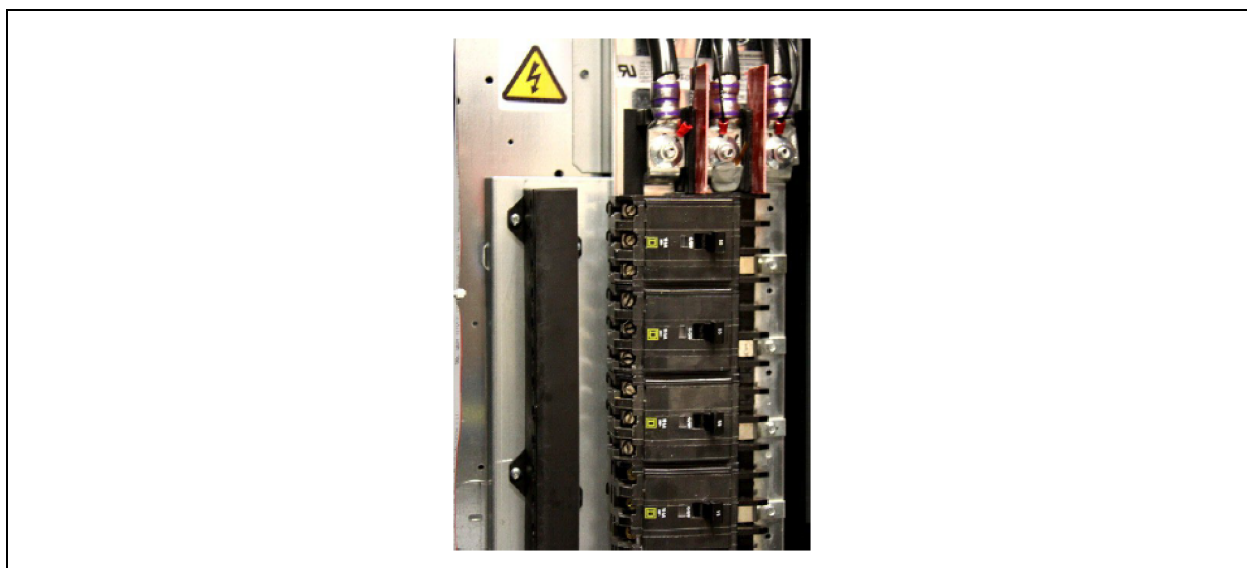


**WARNING!** Dangerous voltages exist in power distribution units and power conditioning units. To ensure maximum safety, all circuit breakers in the panelboard should be removed of power and the input feeder breaker should be turned Off and locked-out in accordance with NEC and local/state code.

**NOTE:** Vertiv™ Liebert® LDMF components and any other monitoring devices should be installed only by properly trained and qualified personnel.

### 4.1 Installing a BSM (CT Module Assembly)

Figure 4.1 Installing a BSM (CT Module Assembly)



In most cases the BSM-the CT Module-is factory-installed and no further work is required. If a CT Module must be added, it attaches easily to the side of a panelboard to monitor any combination of 1-, 2- and, 3-pole circuit breakers.

- For side-by-side panelboards (21 circuits on each side), attach one CT Module to each side of the panelboard, ensuring that the center of the CT hole lines up to the branch circuit breaker connection.
- For Square-D Inline panelboards (42 circuits in a row), the two CT second, lower CT Module so that the two cutout sections line up, then attach the screws to secure the CT Modules to the panelboard.
- For GE Inline type panelboards, the two CT.
- Modules fit end to end. Flip the second, lower CT Module so that the 50-pin ribbon cable connector, mounted on the bottom of the CT Module, lines up with the hole in the panelboard mounting bracket.

Install the circuit breakers according to the manufacturer's documentation. Route the circuit wire through the center of the CT and attach securely to the circuit breaker.

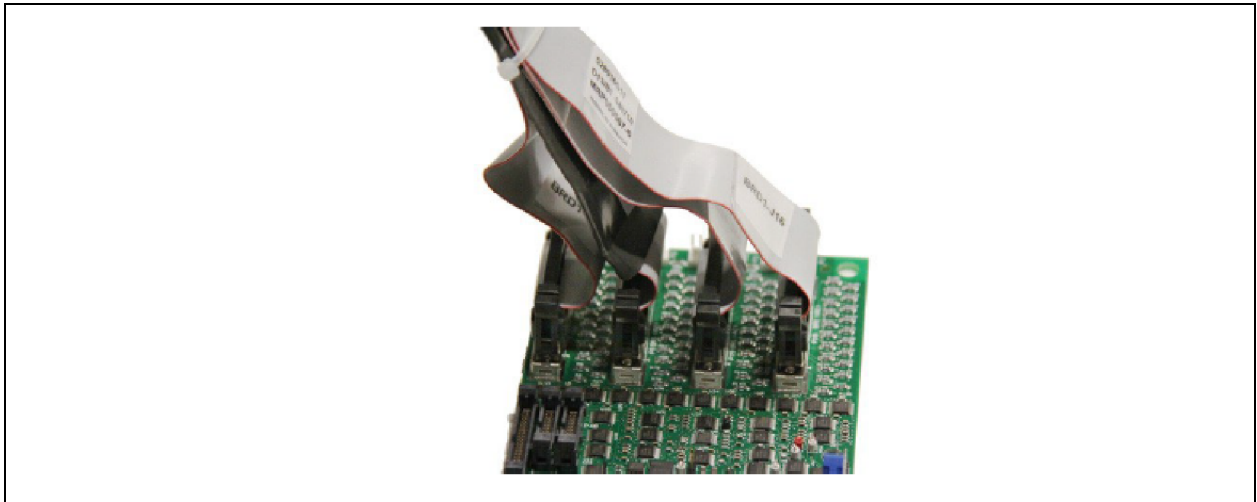
### 4.1.1 Connecting Panelboards A and B

The CT Module connects to the PMB via a 50-pin ribbon cable attached to the back of the CT Module. Route the ribbon cable and attach to the appropriate connector (See **Figure 4.2** below ).

There are four connectors that are labeled for easy identification: two for Panelboard A (A1 and A2) and two for Panelboard B (B1 and B2).

- Connect the CT module that will monitor Circuits 1-21 to the A1 or B1 connector, depending on whether the CT Module is monitoring Panelboard A or B.
- Connect the CT module that will monitor Circuits 22-42 to the corresponding A2 or B2 connector.

**Figure 4.2 Connecting Panelboards A and B**



Circuits Monitored	Panelboard A Connector	Panelboard B Connector
1-21	A1	B1
22-42	A2	B2

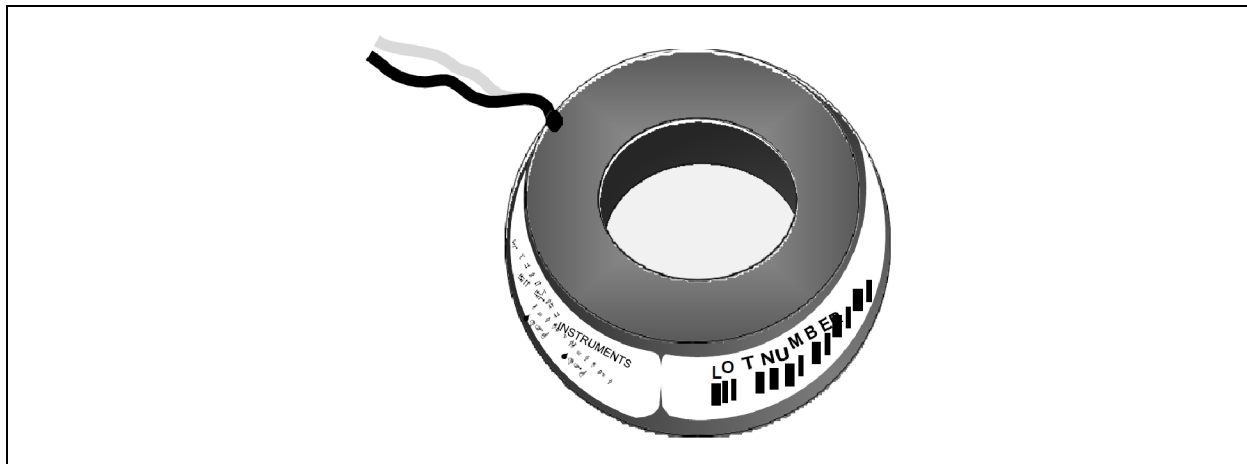
To configure the branch circuits, refer to [Add a Circuit Breaker](#) on page 41 .

**NOTE:** Panelboard A is either Panelboard 1 or Panelboard 3.

**NOTE:** Panelboard B is either Panelboard 2 or Panelboard 4 depending on which Vertiv™ Liebert® LDMF Control Board is being configured.

## 4.2 Installing a Solid-Core Current Transformer

Figure 4.3 Installing a Solid-Core Current Transformer



**WARNING!** A solid-core CT cannot be installed on a wire while current is flowing through the wire. Damage to the burden resistor and CT will occur. Power must be removed before installing and/or removing any CT. CT's should be installed only by properly trained qualified electricians.

The CT for the panelboard main input circuit breaker is hard-wired to the connectors. Removing CT wires from the connector requires a pin extraction tool. Contact Vertiv Support at 800-543-2378 for assistance.

**NOTE:** When replacing or installing a CT, ensure that the replacement CT has a secondary rating of 1 A—for example, 100:1, 200:1, 500:1 or, 1000:1. Using a higher-rated CT—for example, 100:5 or 500:5—will damage the burden resistors on the PIB board.

Typically the 3-phase and neutral wires utilize a CT rating of 100:1, 200:1 500:1 or, 1000:1, while the ground wire utilizes a CT rating of 100:1.

Route the circuit wire through the core of the CT and wire-tie the CT to the cable. Refer to the manufacturer's documentation for proper orientation to ensure accurate readings.

**NOTE:** When installing CT's for a large branch circuit breaker or subfeed, verify which monitoring board is installed.

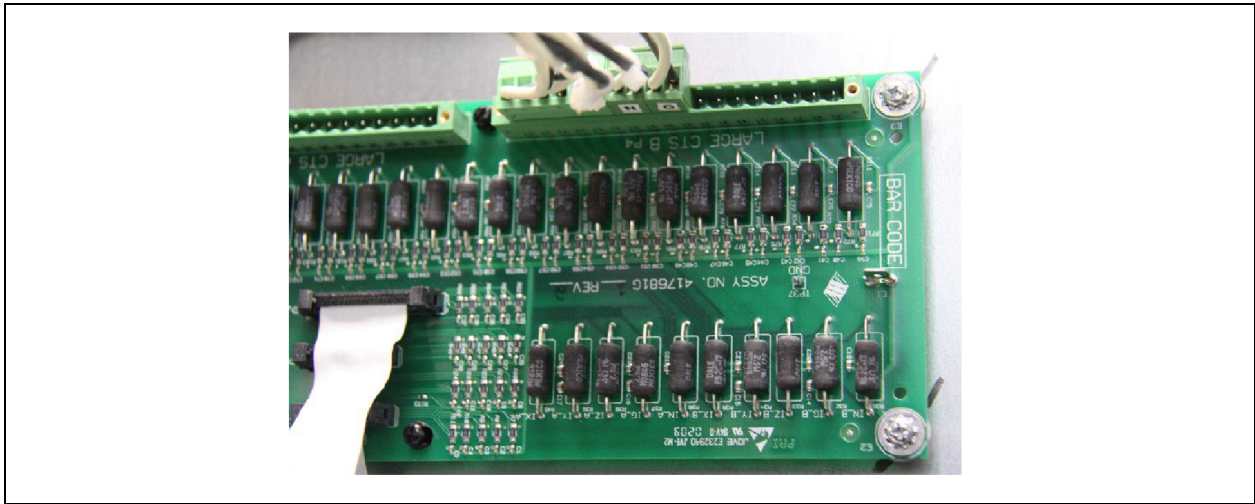
A PIB can support up to three subfeeds.

One LIB can support up to eight output and/or subfeed breakers.

Two LIB boards are provided to support up to 16 output and/or subfeed breakers.

## 4.3 Installing a Current Transformer on the PIB Interface Board

Figure 4.4 Installing a Current Transformer on the PIB Interface Board



If subfeed breakers are ordered with the unit, the phase, neutral and ground CTs are wired to the Interface Board. The CTs will be zip-tied inside the equipment for the electrician to install on each conductor when the conductors are wired to the subfeed/large branch breaker. The ground and neutral CTs for each factory-supplied subfeed or large breaker are factory-installed and wired.

CTs have a white or H1 that depicts how to position the CT on the cable to ensure accurate readings. The white dot or H1 must face toward the source when installing the CT on the phase cables. The neutral conductor CTs are placed in the opposite direction, with the marking faced toward the load. Route the conductors through the core of the CTs and wire-tie the CT to the cable to ensure the CT stays in place.

If subfeed breakers are installed in the field, up to five CTs may be installed (three phases, neutral and ground). The neutral and ground CTs may be omitted if monitoring of neutral and ground is not required. The 5-wire CT kits will be shipped separately and grouped together with each CT with a label indicating whether it is a phase CT, neutral CT or, ground CT.

There are two 18-pin terminal blocks on the Interface Board for large branch circuit breakers and/or subfeeds—one for Panelboard A and one for Panelboard B.

The circuit board is marked with a triangle to indicate Pin 1. Pin 1 should be used for the white wire of CT1 (Phase A). The black wire should be connected to Pin 2. The same pattern will follow for the remaining CTs.

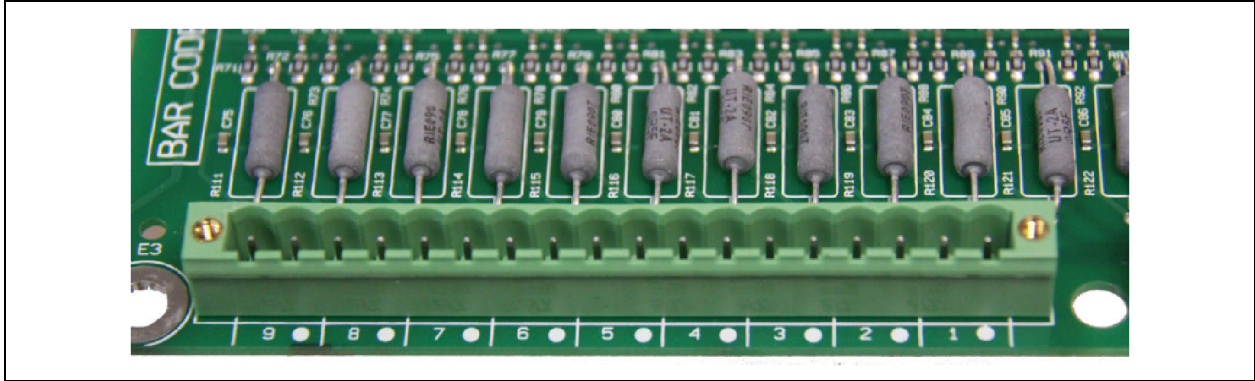
After all CTs are installed, use the Configuration tool to label and set alarm parameters. To configure the Vertiv™ Liebert® LDMF, see [Add a Circuit Breaker](#) on page 41.

If the Power Distribution Center is supplied with optional isolated ground, the isolated ground circuit can be monitored by the Liebert® LDMF. Usually the CT is already installed and wired to the Large Branch Terminal Block at the factory. If not, perform the following steps:

### For Isolated Ground CT Installation only

- Connect the isolated ground CT to Pins 17 and 18 on the two 18-pin terminal blocks on the Interface Board.
- Connect the isolated ground CT white wire to Pin 17 and the CT black wire to Pin 18.

Figure 4.5 Large Branch Breaker CT Wiring



Refer to the following example and **Table 4.1** below for wiring configuration details.

**Example:** When installing a subfeed breaker where the three phases, neutral and ground will be monitored, the CTs should be wired as follows:

Table 4.1 Large Branch Breaker CT Wiring

Pin	Wiring
1	Phase A CT White wire
2	Phase A CT Black wire
3	Phase B CT White wire
4	Phase B CT Black wire
5	Phase C CT White wire
6	Phase C CT Black wire
7	Neutral CT White wire
8	Neutral CT Black wire

If a second subfeed or large branch breaker will be installed, the same pattern will continue. Pins 11 and 12 will be Phase A CT for the second breaker, Pins 13 and 14 will be Phase B CT and so on.

Table 4.2 CT Table for Interface Board

Configuration 1: Four Modules																			
Connector P3 (A)	Position	9	•	8	•	7	•	6	•	5	•	4	•	3	•	2	•	1	•
	Wire color	B	W	B	W	B	W	B	W	B	W	B	W	B	W	B	W	B	W
	CT	CT9 or IG		CT8		CT7		CT6		CT5		CT14		CT3		CT2		CT1	
Connector P4 (B)	Position	9	•	8	•	7	•	6	•	5	•	4	•	3	•	2	•	1	•
	Wire color	B	W	B	W	B	W	B	W	B	W	B	W	B	W	B	W	B	W
	CT	CT18 or IG		CT17		CT16		CT15		CT14		CT13		CT12		CT11		CT10	

Configuration 2: Two Modules with Large Branch Breaker CT's																			
Connector P3 (A)	Position	9	•	8	•	7	•	6	•	5	•	4	•	3	•	2	•	1	•
	Wire color	B	W	B	W	B	W	B	W	B	W	B	W	B	W	B	W	B	W
	CT	LB9 or IG		LB8		LB7		LB6		LB5		LB4		LB3		LB2		LB1	
Connector P4 (B)	Position	9	•	8	•	7	•	6	•	5	•	4	•	3	•	2	•	1	•
	Wire color	B	W	B	W	B	W	B	W	B	W	B	W	B	W	B	W	B	W
	CT	LB18 or IG		LB17		LB16		LB15		LB14		LB13		LB12		LB11		LB10	

Configuration 3: Four Modules with Two 5-Wire Subfeed Breaker CT's																			
Connector P3 (A)	Position	9	•	8	•	7	•	6	•	5	•	4	•	3	•	2	•	1	•
	Wire color	B	W	B	W	B	W	B	W	B	W	B	W	B	W	B	W	B	W
	CT									LB5		LB4		LB3		LB2		LB1	
	Phase	IG								G1		N1		C1		B1		A1	
Connector P4 (B)	Position	9	•	8	•	7	•	6	•	5	•	4	•	3	•	2	•	1	•
	Wire color	B	W	B	W	B	W	B	W	B	W	B	W	B	W	B	W	B	W
	CT									LB10		LB9		LB8		LB7		LB6	
	Phase	IG								G2		N2		C2		B2		A2	

Configuration 4: Four Modules with Three 5-Wire Subfeed Breaker CT's																			
Connector P3 (A)	Position	9	•	8	•	7	•	6	•	5	•	4	•	3	•	2	•	1	•
	Wire color	B	W	B	W	B	W	B	W	B	W	B	W	B	W	B	W	B	W
	CT					LB12		LB11		LB5		LB4		LB3		LB2		LB1	
	Phase	IG				G3		N3		G1		N1		C1		B1		A1	
Connector P4 (B)	Position	9	•	8	•	7	•	6	•	5	•	4	•	3	•	2	•	1	•
	Wire color	B	W	B	W	B	W	B	W	B	W	B	W	B	W	B	W	B	W
	CT			LB13		LB12		LB11		LB10		LB9		LB8		LB7		LB6	
	Phase	IG		C3		B3		A3		G2		N2		C2		B2		A2	

Configuration 5: Four Modules with Six 3-Wire Subfeed Breaker CT's																			
Connector P3 (A)	Position	9	•	8	•	7	•	6	•	5	•	4	•	3	•	2	•	1	•
	Wire color	B	W	B	W	B	W	B	W	B	W	B	W	B	W	B	W	B	W
	CT	LB9		LB8		LB7		LB6		LB5		LB4		LB3		LB2		LB1	
	Phase	C3		B3		A3		C2		B2		A2		C1		B1		A1	
Connector P4 (B)	Position	9	•	8	•	7	•	6	•	5	•	4	•	3	•	2	•	1	•
	Wire color	B	W	B	W	B	W	B	W	B	W	B	W	B	W	B	W	B	W
	CT	LB18		LB17		LB16		LB15		LB14		LB13		LB12		LB11		LB10	
	Phase	C6		B6		A6		C5		B5		A5		C4		B4		A4	

Configuration 6: Three Modules with Nine Large Branch Breaker CT's																			
Connector P3 (A)	Position	9	•	8	•	7	•	6	•	5	•	4	•	3	•	2	•	1	•
	Wire color	B	W	B	W	B	W	B	W	B	W	B	W	B	W	B	W	B	W
	CT	LB9 or IG		LB8		LB7		LB6		LB5		LB4		LB3		LB2		LB1	
	Phase	C3		B3		A3		C2		B2		A2		C1		B1		A1	
Connector P4 (B)	Position	9	•	8	•	7	•	6	•	5	•	4	•	3	•	2	•	1	•
	Wire color	B	W	B	W	B	W	B	W	B	W	B	W	B	W	B	W	B	W
	CT	C6		B6		A6		C5		B5		A5		C4		B4		A4	

W = White  
 B = Black  
 IG = Isolated Ground CT  
 LB = Large Branch Breaker CT  
 A = A Phase CT  
 B = B Phase CT  
 C = C Phase CT  
 N = Neutral CT  
 G = Ground CT

## 4.4 Connecting a Current Transformer to the PM4 Large Interface Board (PLIB)

PLIB can monitor eight 4-wire or 5-wire output/subfeed breakers. Two LIB boards are provided to support up to 16 output and/or subfeed breakers. If subfeed breakers are ordered with the unit, the phase CTs are installed and wired to the PLIB. The neutral and ground CTs are also factory-supplied and wired to the PLIB as required.

CTs have a white dot or H1 marking that depicts how to position the CT to ensure accurate readings. The white dot or H1 marking must face toward the load when installing the CT on the ground and neutral cable. The phase CT's are placed in the opposite direction, with the marking faced toward the source. Route the neutral and ground cable through the core of the specified CT and wire-tie the CT to the cable.

If subfeed breakers are installed in the field, up to five CTs may be installed to monitor a subfeed breaker (three phases, neutral and ground). The neutral and ground CTs may be omitted if monitoring of neutral and ground is not required.

The designators on the PLIB are different from those on the Interface Board.

- CT1 (Phase A white wire) begins on TB1 (CT1+) and the black wire connects to (CT1-).
- The Ground CT for the first subfeed/output circuit breaker connects to TB4 CT35.

The designators on the PLIB are different from those on the Interface Board.

- CT1 (Phase A white wire) begins on TB1 (CT1+) and the black wire connects to (CT1-).
- The Ground CT for the first subfeed/output circuit breaker connects to TB4 CT35.

First Breaker			Second Breaker		
CT1+	Phase A CT	White wire	CT5+	Phase A CT	White wire
CT1	Phase A CT	Black wire	CT5	Phase A CT	Black wire
CT2+	Phase B CT	White wire	CT6+	Phase B CT	White wire
CT2	Phase B CT	Black wire	CT6	Phase B CT	Black wire
CT3+	Phase C CT	White wire	CT7+	Phase C CT	White wire
CT3	Phase C CT	Black wire	CT7	Phase C CT	Black wire
CT4+	Neutral CT	White wire	CT8+	Neutral CT	White wire
CT4	Neutral CT	Black wire	CT8	Neutral CT	Black wire
CT35+	Ground CT	White wire	CT36+	Ground CT	White wire
CT35	Ground CT	Black wire	CT36	Ground CT	Black wire

If more output or subfeed CTs must be installed, continue in the same pattern shown above.

- Connect the Phase A CT for the second breaker on CT5 (white wire to CT5+, black to CT5-).
- Connect the Ground CT for the second breaker to CT36 (white wire to CT36+, black to CT36-).
- Continue the same pattern until all CT connections are used or there are no more outputs or subfeed CTs to add.

**Table 4.3 CT Table for PM4 Large Interface Board**

Connector TB1	PCB Label	CT9		CT8		CT7		CT6		CT5		CT4		CT3		CT2		CT1	
	Pins	18	17	16	15	14	13	12	11	10	9	8	7	6	5	4	3	2	1
		-	+	-	+	-	+	-	+	-	+	-	+	-	+	-	+	-	+
	Wire color	B	W	B	W	B	W	B	W	B	W	B	W	B	W	B	W	B	W
	CT	CT9		CT8		CT7		CT6		CT5		CT4		CT3		CT2		CT1	
	Phase	A3		N2		C2		B2		A2		N1		C1		B1		A1	

Connector TB2	PCB Label	CT18		CT17		CT16		CT15		CT14		CT13		CT12		CT11		CT10	
	Pins	18	17	16	15	14	13	12	11	10	9	8	7	6	5	4	3	2	1
		-	+	-	+	-	+	-	+	-	+	-	+	-	+	-	+	-	+
	Wire color	B	W	B	W	B	W	B	W	B	W	B	W	B	W	B	W	B	W
	CT	CT18		CT17		CT16		CT15		CT14		CT13		CT12		CT11		CT10	
	Phase	B5		A5		N4		C4		B4		A4		N3		C3		B3	



Connector TB3	PCB Label	CT27		CT26		CT25		CT24		CT23		CT22		CT21		CT20		CT19	
	Pins	18	17	16	15	14	13	12	11	10	9	8	7	6	5	4	3	2	1
		-	+	-	+	-	+	-	+	-	+	-	+	-	+	-	+	-	+
	Wire Color	B	W	B	W	B	W	B	W	B	W	B	W	B	W	B	W	B	W
	CT	CT27		CT26		CT25		CT24		CT23		CT22		CT21		CT20		CT19	
	Phase	C7		B7		A7		N6		C6		B6		A6		N5		C5	

Connector TB4	PCB Label	CT36		CT35		CT34		CT33		CT32		CT31		CT30		CT29		CT28	
	Pins	18	17	16	15	14	13	12	11	10	9	8	7	6	5	4	3	2	1
		-	+	-	+	-	+	-	+	-	+	-	+	-	+	-	+	-	+
	Wire Color	B	W	B	W					B	W	B	W	B	W	B	W	B	W
	CT	CT2		CT1		NONE		NONE		CT32		CT31		CT30		CT29		CT28	
	Phase	G2		G1						N8		C8		B8		A8		N7	

Connector TB5	PCB Label	CT42		CT41		CT40		CT39		CT38		CT37	
	Pins	12	11	10	9	8	7	6	5	4	3	2	1
		-	+	-	+	-	+	-	+	-	+	-	+
	Wire Color	B	W	B	W	B	W	B	W	B	W	B	W
	CT	CT8		CT7		CT6		CT5		CT4		CT3	
	Phase	G8		G7		G6		G5		G4		G3	

Table 4.4 CT Table for PM4 Large Interface Board

Connector TB1	PC Label	CT9		CT8		CT7		CT6		CT5		CT4		CT3		CT2		CT1	
	Pins	18	17	16	15	14	13	12	11	10	9	8	7	6	5	4	3	2	1
		-	+	-	+	-	+	-	+	-	+	-	+	-	+	-	+	-	+
	Wire Color	B	W	B	W	B	W	B	W	B	W	B	W	B	W	B	W	B	W
	CT	CT41		CT40		CT39		CT38		CT37		CT36		CT35		CT34		CT33	
	Phase	A11		N10		C10		B10		A10		N9		C9		B9		A9	

Connector TB2	PC Label	CT18		CT17		CT16		CT15		CT14		CT13		CT12		CT11		CT10	
	Pins	18	17	16	15	14	13	12	11	10	9	8	7	6	5	4	3	2	1
		-	+	-	+	-	+	-	+	-	+	-	+	-	+	-	+	-	+
	Wire Color	B	W	B	W	B	W	B	W	B	W	B	W	B	W	B	W	B	W
	CT	CT50		CT49		CT48		CT47		CT46		CT45		CT44		CT43		CT42	
	Phase	B13		A13		N12		C12		B12		A12		N11		C11		B11	

Connector TB3	PC Label	CT27		CT26		CT25		CT24		CT23		CT22		CT21		CT20		CT19	
	Pins	18	17	16	15	14	13	12	11	10	9	8	7	6	5	4	3	2	1
		-	+	-	+	-	+	-	+	-	+	-	+	-	+	-	+	-	+
	Wire Color	B	W	B	W	B	W	B	W	B	W	B	W	B	W	B	W	B	W
	CT	NONE		NONE		NONE		NONE		NONE		NONE		NONE		CT52		CT51	
	Phase															N13		C13	

Connector TB4	PC Label	CT36		CT35		CT34		CT33		CT32		CT31		CT30		CT29		CT28	
	Pins	18	17	16	15	14	13	12	11	10	9	8	7	6	5	4	3	2	1
		-	+	-	+	-	+	-	+	-	+	-	+	-	+	-	+	-	+
	Wire Color	B	W	B	W					B	W	B	W	B	W	B	W	B	W
	CT	CT10		CT9		NONE		NONE		NONE		NONE		NONE		NONE		NONE	
	Phase	G10		G9															

Connector TB5	PC Label	CT42		CT41		CT40		CT39		CT38		CT37	
	Pins	12	11	10	9	8	7	6	5	4	3	2	1
		-	+	-	+	-	+	-	+	-	+	-	+
	Wire Color	B	W	B	W	B	W	B	W	B	W	B	W
	CT	NONE		NONE		NONE		CT13		CT12		CT11	
	Phase							G13		G12		G11	

W = White  
 B = Black  
 A = A Phase  
 B = B Phase  
 C = C Phase  
 N = Neutral  
 G = Ground

## 5 Operation

The Vertiv™ Liebert® LDMF is a factory-installed option to provide monitoring of the main breaker, branch circuit breakers and subfeed breakers. It may be installed in the Vertiv™ Liebert® PPC, Vertiv™ Liebert® FDC, Vertiv™ Liebert® FPC, Vertiv™ Liebert® RX and the Vertiv™ Liebert® RDC.

Software available on the Liebert Web site (See [Downloading the Software](#) on page 26 ) can be installed on a desktop or laptop computer (PC) to monitor status and configure breaker parameters and alarm setpoints. These monitoring and configuration functions are described in [Using the Monitor Tool \(Used Only for Startup and Diagnostics\)](#) on page 27 and [Using the Configuration Tool](#) on page 31 .

The Liebert® LDMF has an optional local display in conjunction with the remote monitoring capability. The display allows end users to view the panelboard main information as well as each individual branch circuit breaker and/or subfeed data. Alarm status may also be viewed from the local display for up-to-date breaker status.

The Liebert® LDMF monitors and displays the parameters listed in **Table 5.1** below .

**Table 5.1 Parameters Monitored for Breakers**

Parameters	Displayed and Monitored for Each:			
	Panelboard Branch Circuit Breaker	Panelboard Main Circuit Breaker and SqD I-Line Panelboard	SqD I-Line Panelboard Circuit Breaker	Subfeed Circuit Breaker
Voltage				
Line-to-line	-	4	-	-
Line-to-neutral		4	-	-
Phase current	4	4	4	4
Neutral current	-	4	4	4
Ground current	-	4	4	4
kVA	-	4	4	4
kW	4	4	4	4
kW-hours	4	4	4	4
Percent load	4	4	4	4
Power factor	—	4	4	4
Crest factor	—	4	4	4
Voltage Total Harmonic Distortion (THD)	-	4	4	4
Current Total Harmonic Distortion (THD)	-	4	4	4

Circuit identification and status of each breaker are also displayed.

**NOTE:** Before making any changes to an existing configuration or uploading a file to another Liebert® LDMF system, make a note of the Software Address. When overwriting an existing configuration file due to changes, modifications or breaker addition/deletion, the Software Address will revert to the value of the file that is loaded. This can lead to incorrect Software Addresses causing Modbus communication errors.

## 5.1 Alarms

The Vertiv™ Liebert® LDMF constantly monitors electrical data for each breaker and subfeed. When the unit detects an alarm condition, it annunciates and displays alarm messages via the Monitor program (See [Using the Monitor Tool \(Used Only for Startup and Diagnostics\)](#) on page 27.) as well as showing the alarm on the local display (if installed).

Alarms must be manually reset after the alarm condition has been corrected and may be reset through Modbus or by pressing the alarm Silence/Reset button on the front display assembly.

**To facilitate troubleshooting:**

- All alarms are stored in non-volatile memory to protect against erasure by a power outage.

All alarm thresholds for monitored parameters are adjustable by using the Configuration tool to match site requirements (See [Using the Configuration Tool](#) on page 31).

**Table 5.2** below shows the types of alarms for the various types of breakers, along with a description, factory default setpoints and allowable range for each.

**Table 5.2 Alarm Conditions and Factory Setpoints**

Alarm	Description	Default Setting	Range	Comments
<b>Branch Breakers</b>				
Overcurrent warning	Current exceeds 75% of breaker amps	15 A	0-200%	0% Disables
Overcurrent alarm	Current exceeds 80% of breaker amps	16 A	0-200%	-
Low current alarm	Minimum current level of a branch breaker	0% (disables the alarm)	0-70%	-
<b>Panelboard Main Breaker and SqD I-Line Panelboard</b>				
Phase overcurrent Warning	Current exceeds 75% of breaker amps	170 A	0-200%	0% Disables
Phase overcurrent alarm	Current exceeds 80% of breaker amps	180 A	0-200%	-
Neutral overcurrent alarm	Current exceeds 95% of breaker amps	214 A	0-200%	-
Ground overcurrent alarm	Current exceeds 5 amps (15-125 kVA)	5 A	1-100 A	-
	Current exceeds 10 amps (150-225 kVA)	10 A	1-100 A	-
	Current exceeds 15 amps (300 kVA)	15 A	1-100 A	-
	Current exceeds 20 amps (450 kVA)	20 A	1-100 A	-
	Current exceeds 25 amps (800 kVA)	25 A	1-100 A	-
Overvoltage alarm	At least one of the line-to-line voltages exceeds +6% of nominal	-	0-50%	100% to Disable
Undervoltage alarm	At least one of the line-to-line or line-to- neutral voltages falls below -13% of nominal	-	0-50%	100% to Disable
<b>Subfeed Breakers and I-Line Output Breakers</b>				
Phase overcurrent warning	Current exceeds 75% of breaker amps	170 A	0-200%	0% Disables
Phase overcurrent alarm	Current exceeds 80% of breaker amps	180 A	0-200%	-

**Table 5.2 Alarm Conditions and Factory Setpoints (continued)**

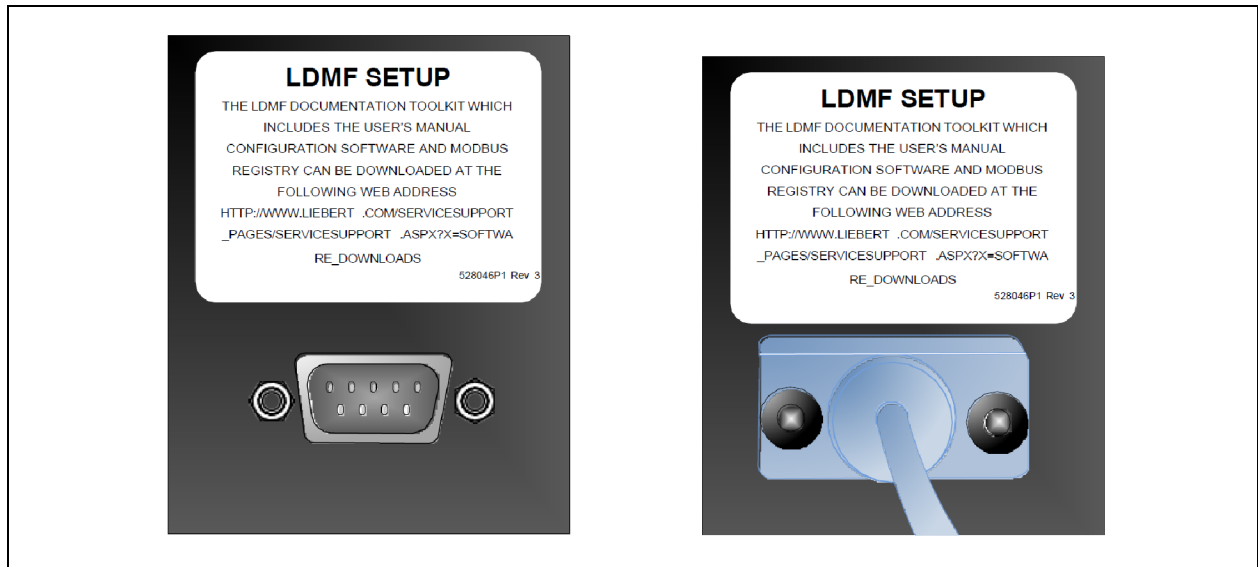
Alarm	Description	Default Setting	Range	Comments
Low current warning	Minimum current level of a branch breaker	0% (disables the alarm)	0-70%	-
Ground overcurrent alarm	Current exceeds 5 amps	5 A	1-100 A	-
alarm	Description	Default setting	Range	Comments
Summary alarm	Detects and annunciates upon occurrence of any alarm	-	-	-
Panelboard summary alarm	Detects and annunciates upon occurrence of branch or panelboard main breaker alarm	-	-	-

## 5.2 Communication

Connecting locally to the Vertiv™ Liebert® LDMF Monitoring option requires a female-to-female (F-F) DB9 null modem cable. There will be an external port on the Liebert Power product labeled LDMF SETUP. Connect the DB9 null modem cable to a local PC. Once connected you may run any of the provided software tools that can be downloaded from the Liebert Web site (See [Downloading the Software](#) on the next page ).

### 5.2.1 LDMF Setup Port Connection

The local LDMF Setup port is not intended to be a service terminal or hyperterminal connection. It is intended only for use of the Liebert® LDMF software tools provided.

**Figure 5.1 LDMF Setup Port Connection**

**NOTE:** The images above are for illustration only. The location of the external port may vary.

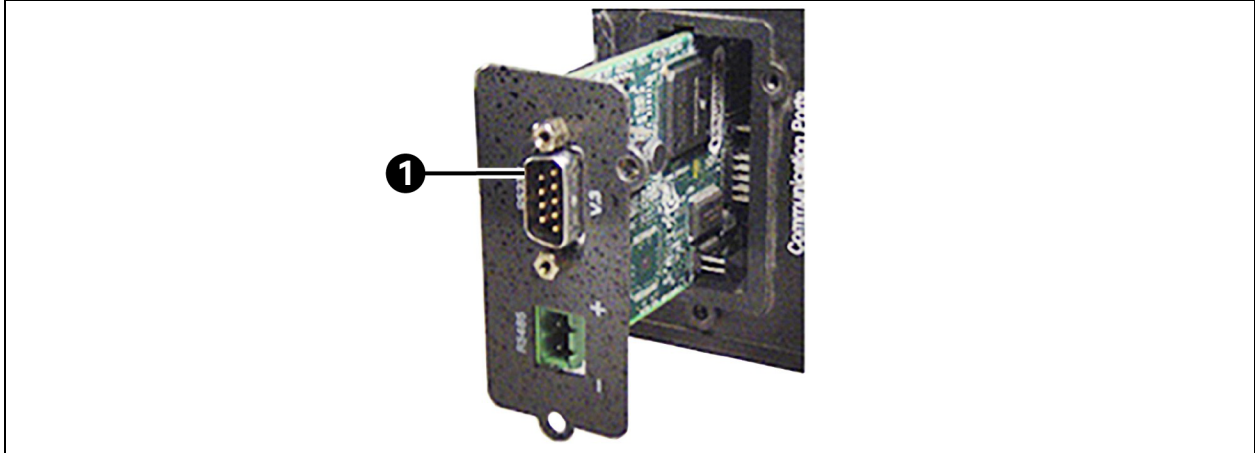
### 5.2.2 Modbus Connection

Use the Modbus port for remote communication. The Liebert® LDMF supports two-wire RS-485 and Ethernet connections (customer-installed).

**To connect to the Modbus port:**

- Look for Connector RS-485 on the Vertiv™ Liebert® IntelliSlot™ IS-UNITY-DP or IS-485S card for Modbus 485, or IS- IPBMS or IS-UNITY-DP card for Modbus IP.
- Refer to the following figure for proper connection points.

**Figure 5.2 RS-232 Port**



Item	Description
1	RS-232 Port

### 5.3 Downloading the Software

The Vertiv™ Liebert® LDMF has three software tools for monitoring, configuration and firmware updates:

- Monitoring-See [Using the Monitor Tool \(Used Only for Startup and Diagnostics\)](#) on the facing page .
- Configuration-See [Using the Configuration Tool](#) on page 31 .

These programs may be downloaded at no charge or license fee at the Liebert Web site, [www.Vertivco.com](http://www.Vertivco.com). Under Service and Support, choose Software Downloads.

- Click on the link for the LDMF - mm/yyyy Toolkit:  
where mm/yyyy is the month and year of the update-for example, 08/2016

**NOTE: There are two versions of Liebert® Distribution Monitoring software.**

**Be sure to select the LDMF version, which is for units with a setup port labeled LDMF Setup.**

**Do NOT choose the Liebert® Distribution Monitoring (LDM) Tool Kit. (The LDM Tool Kit is used on units with a setup port labeled LDM Setup.)**

- Save the file to a computer (PC) and extract the contents.

**NOTE: The software may be updated and changed without any notification. Check the Web site regularly to ensure the software is up-to-date.**

## 5.4 Using the Monitor Tool (Used Only for Startup and Diagnostics)

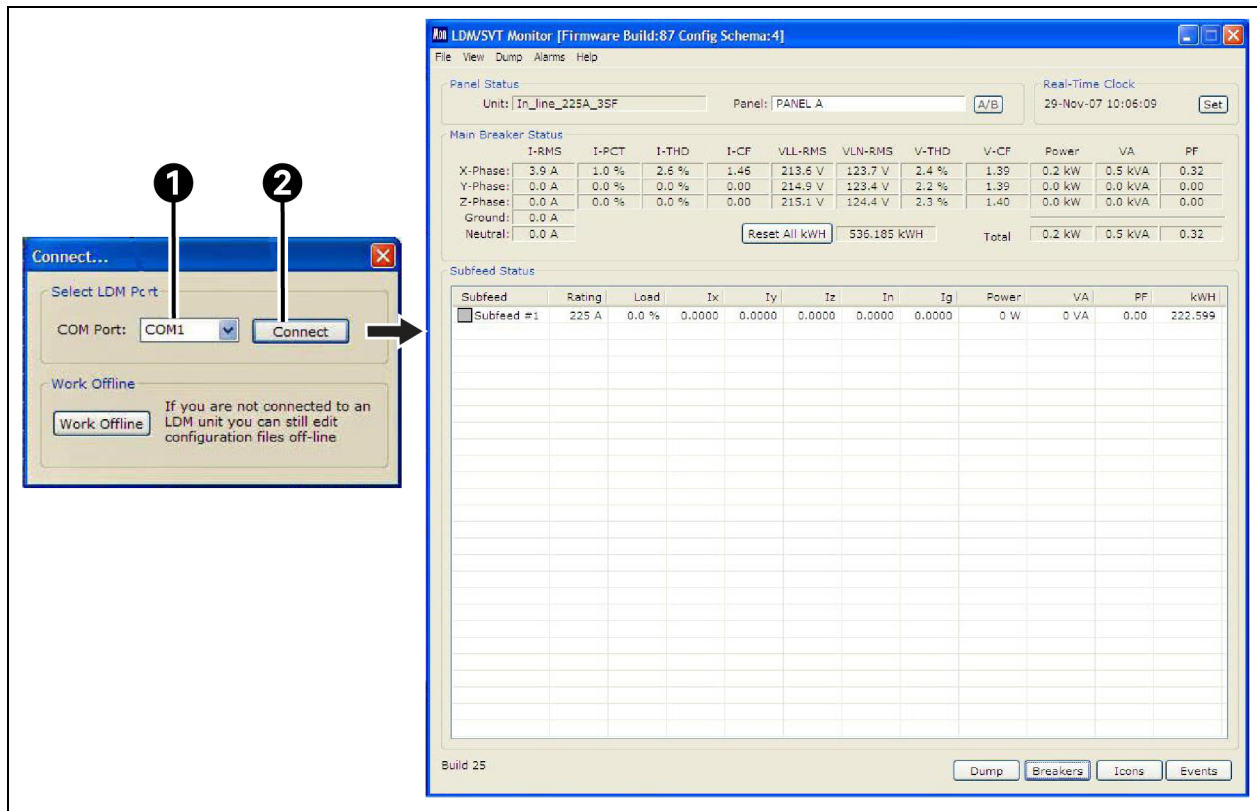
The Monitor tool supports a local connection through the LDMF Setup port. The tool displays the following information:

- Main input voltage and currents.
- Total power.
- Individual branch circuit breaker currents.
- System clock (date and time).
- Reset kWh function.

### 5.4.1 Starting the Monitor Tool

- If needed, download the latest version of the software (See [Downloading the Software](#) on the previous page ).
- Run the executable file Monitor-xx.exe (where xx is the latest version) to start the Monitor tool.
- In the Connect window, select the appropriate COM port, shown below left. The dialog box lists available ports only. If a port is in use, it does not appear in the list.
- Click Connect.
- The Monitoring main window, below right, opens after communication is established.

Figure 5.3 Starting the Monitor Tool

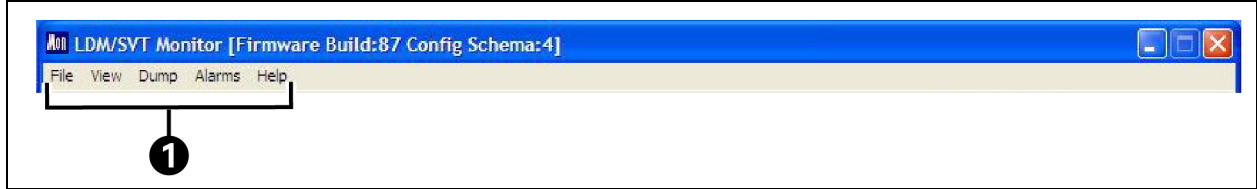


Item	Description
1	COM port
2	Connect

### 5.4.2 Monitor Menu Options

The Monitor window has a menu bar at the top with a drop-down list of options for each menu. **Table 5.3** below summarizes the options available in these menus.

**Figure 5.4 Monitor Menu Options**



Item	Description
1	Menu options

**Table 5.3 Monitor Menu Options**

Menu Option	Function
<b>File Menu</b>	
Exit	Terminates the monitoring session and closes the monitor program.
<b>View Menu</b>	
Breakers	Updates the status of all branch breakers for the selected panel in the breaker status area.
Subfeeds	Updates the status of all subfeed breakers for the selected panel in the breaker status area.
<b>Alarms Menu</b>	
Choose one of three options-raw, filtered or latched-to specify how alarms are displayed.	
Note that alarms sent over modbus are latched independent of changes performed in the alarms menu.	
Raw	The raw alarm state is the instantaneous state of the alarm. It is not filtered and has no hysteresis. When raw is selected, an alarm is active whenever the latest reading exceeds the set point and is cleared as soon as the reading returns to a level within the set point range.
Filtered	The filtered alarm uses the hysteresis interval to suppress transient alarms. A filtered alarm is cleared after the alarm condition remains cleared for longer than the hysteresis interval.
Latched	Latched alarms behave like filtered alarms that get stuck on. A latched alarm stays active until the alarm is manually cleared.
Clear All	Clears all latched alarms for the selected panel. Any alarm condition that is still active is latched again after the hysteresis interval passes.
<b>Help Menu</b>	
About	Displays information about Liebert Distribution Monitoring.

### 5.4.3 Panel Status and Real-Time Clock

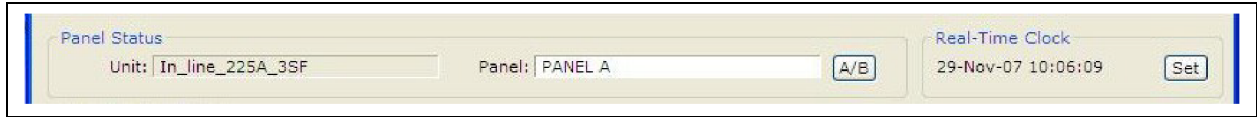
The Panel Status area displays:

- The name of the Vertiv™ Liebert® LDMF in the Unit box.
- The currently selected panel in the Panel box.



To choose a different panel, click on the panel name or the A/B button. If the selected panel has any active alarms, the panel name appears in white text with a red background.

**Figure 5.5 Panel Status and Real-Time Clock**



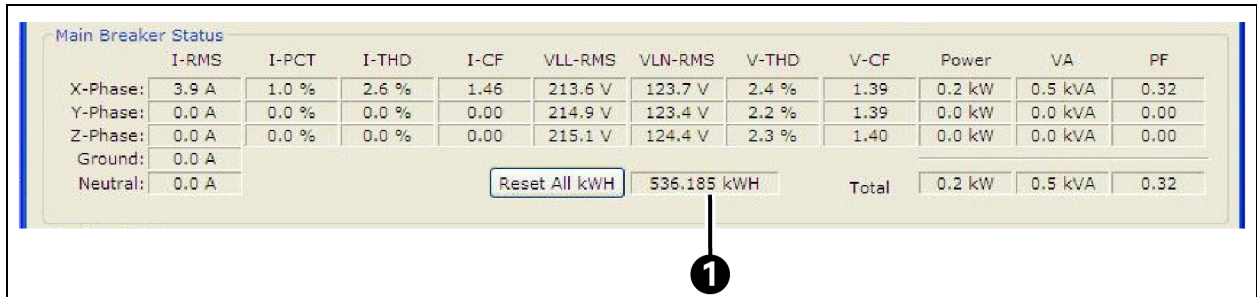
The Real-Time Clock displays the time as stored in the Liebert® LDMF unit. The time will not display correctly if the time zone is incorrect in the PC. If the time displayed is incorrect and the problem is not caused by a time-zone configuration problem:

- Click the Set button to force the real-time clock to synchronize with the time set on the PC.

### 5.4.4 Main Breaker Status

The Main Breaker Status area displays RMS current, percent load (PCT), total harmonic distortion (THD), crest factor (CF), line-to-line voltage (VLL-RMS), line-to-neutral voltage (VLN-RMS), average power (Power), VA and power factor (PF) for each input phase. If any phase voltage or current is in alarm, the associated field displays white text with a red background.

**Figure 5.6 Main Breaker Status**



Item	Description
1	Metered energy usage for the panel

The metered energy usage for the panel is also displayed in kilowatt hours (kWh), as shown above. To clear all metering information, click the Reset All kWh button.



**CAUTION: Exercise care before using the Reset All kWh button, which resets the kWh usage for the main breaker as well as all branch breakers and subfeed breakers on the panel.**

### 5.4.5 Breaker Status

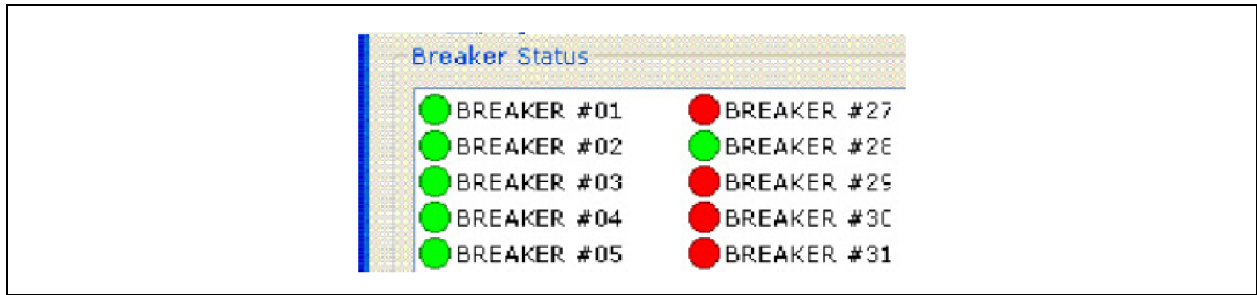
The Breaker Status area displays detailed status for every branch or subfeed breaker on the selected panel. The information may appear in table format or in a list with icons indicating status, depending on whether the Table or Icons button is active (See [Mode Buttons](#) on the next page ).

The example below left shows the table format with details for each branch breaker: type and rating, percent load, individual phase current in amps (I1, I2, I3), power, apparent power (VA), power factor (PF) and, accumulated kilowatt hours (kWh). The example below right shows the icon format.

Figure 5.7 Table View of Breaker Status

Breaker	Type/Rating	Load	I1	I2	I3	Power	VA	PF	kWH
● BREAKER #01	1-Pole 20 A	0.0 %	0.0000	---	---	0 W	0 VA	0.00	41.737
● BREAKER #02	1-Pole 20 A	0.0 %	0.0000	---	---	0 W	0 VA	0.00	123.211
● BREAKER #03	1-Pole 20 A	0.0 %	0.0000	---	---	0 W	0 VA	0.00	41.353
● BREAKER #04	1-Pole 20 A	0.0 %	0.0000	---	---	0 W	0 VA	0.00	15.379
● BREAKER #05	1-Pole 20 A	0.0 %	0.0000	---	---	0 W	0 VA	0.00	13.637

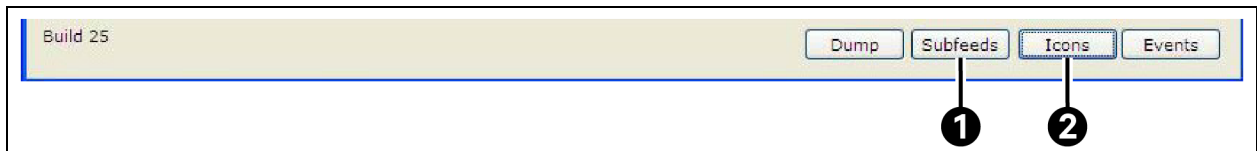
Figure 5.8 Icon View of Breaker Status



### 5.4.6 Mode Buttons

Mode buttons at the bottom of the window allow users to toggle the Breaker Status display between subfeed and branch breakers (Subfeeds/Breakers) or between icon and table formats (Icons/Table) and access the Event Log (Events).

Figure 5.9 Mode Buttons



Item	Description
1	Subfeeds/Breakers button
2	Icons/Table button

Table 5.4 Monitor Mode Buttons

Button	Function
Subfeeds/ Breakers	Toggles between component types in the breaker status area: subfeed breakers and branch breakers. The button label changes when the display is changed.
Icons/ Table	Toggles between formats for displaying data in the breaker status area: icon view and table view. The button label changes when the display is changed.
Events	Displays the event log dialog box.

## 5.5 Using the Configuration Tool

The Configuration tool allows users to set up breakers and view or change their parameters and alarm setpoints.

**NOTE:** End users have the ability to modify an existing configuration file by using the Configuration software available on the Liebert Web site, [www.Vertivco.com](http://www.Vertivco.com) (See [Using the Configuration Tool](#) above ). Ensure the existing configuration file is saved locally before making any modifications. Please contact your local Vertiv representative or call Vertiv Support at 800-543-2378 for assistance.

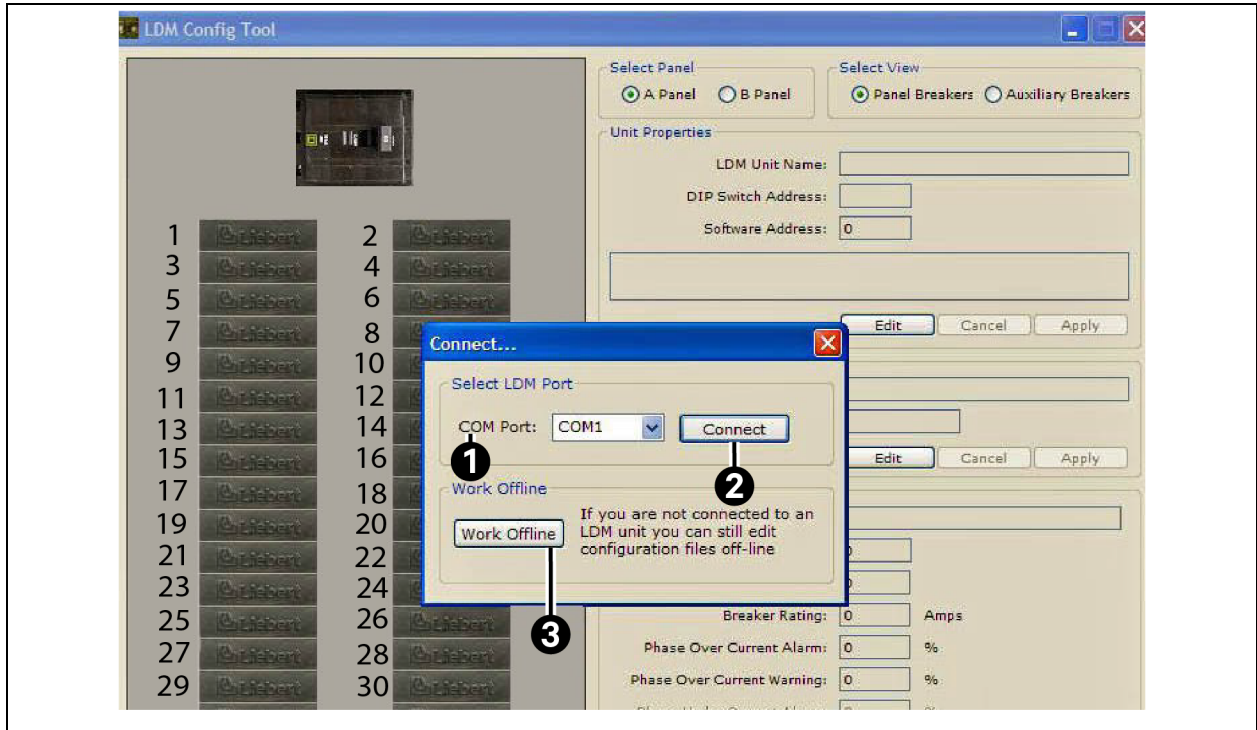
### 5.5.1 Starting the Configuration Program

Before starting the Configuration tool, decide whether you want to connect to the Vertiv™ Liebert® LDMF or work in offline mode. Offline mode allows you to run the configuration tool without being connected to the equipment.

**NOTE:** A configuration file is required for Offline Mode. If one is not available, connect to the equipment locally and save the configuration to disk. See [Install Configuration Changes in the Unit](#) on page 35 and [Save the Configuration File to Disk](#) on page 36 .

To Connect via COM Port	To Work in Offline Mode
If needed, download the latest version of the software (See <a href="#">Downloading the Software</a> on page 26 ).	If needed, download the latest version of the software (See <a href="#">Downloading the Software</a> on page 26 ).
Connect a PC to the Liebert® LDMF via the external DB9 connection. Refer to <a href="#">LDMF Setup Port Connection</a> on page 25 .	Run the file LDMF-Config-xx.exe (where xx is the version number) to start the Configuration program.
Run the file LDMF-Config-xx.exe (where xx is the version number) to start the configuration program.	In the connect window, click the work offline button, shown below
In the connect window, select the appropriate COM port from the list of available ports	When prompted for the configuration file, navigate to the location of the file.
Click connect.	Click open.

Figure 5.10 Starting the Configuration Program



Item	Description
1	COM port
2	Connect locally
3	Work offline

Proceed to [Main Configuration Window Overview](#) below .

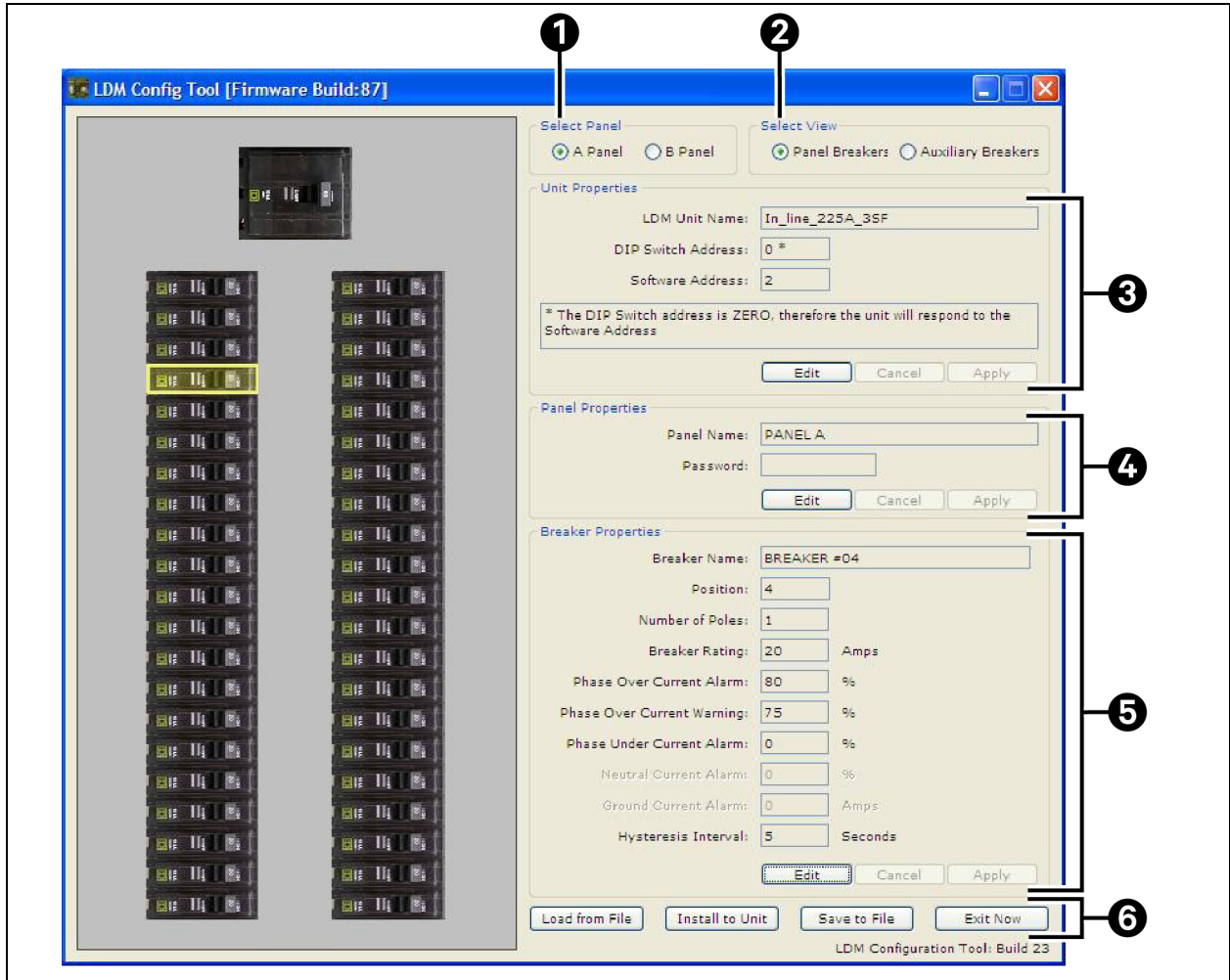
When a local connection to the Vertiv™ Liebert® LDMF can be performed, load the configuration using the instructions in [Load a Configuration File from Disk](#) on page 35 .

### 5.5.2 Main Configuration Window Overview

The Configuration window shows breakers graphically in the left pane and associated breaker data at right. Selecting a breaker in the left pane changes the display of data in the right pane.

**Table 5.5** on page 34 shows the main sections of the window, along with a description and a reference to step-by-step instructions for each.

Figure 5.11 Main Configuration Window Overview



Item	Description
1	Select panel
2	Select view
3	Unit properties
4	Panel properties
5	Breaker properties
6	Mode buttons

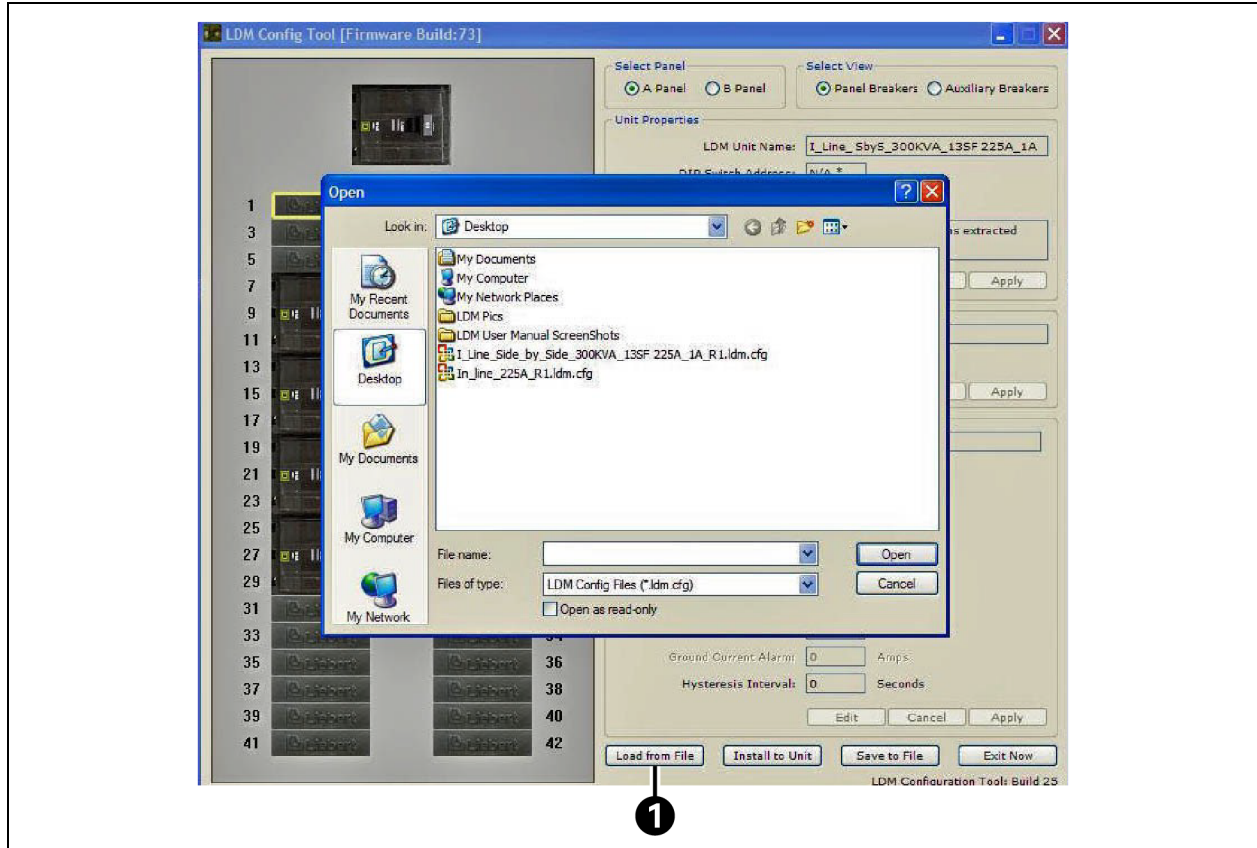
**Table 5.5 Overview of Main Configuration Window**

Section	Function	For Details
Select panel	Toggles the display between panel A and panel B.	<a href="#">Select Panel to View</a> on page 37
Select view	Toggles between panel and auxiliary breakers.	<a href="#">Install Configuration Changes in the Unit</a> on the facing page
Unit properties	Displays the name and communication settings of the Vertiv™ Liebert® LDMF unit.	<a href="#">Edit the Vertiv™ Liebert® LDMF Unit Properties</a> on page 38
Panel properties	Displays the name of the selected panelboard; also password setup for security purposes.	<a href="#">Edit the Panel Properties or Set a Password</a> on page 39
Breaker properties	Displays breaker parameters and alarm setpoints.	<a href="#">Edit the Breaker Properties</a> on page 39
<b>Configuration Mode Buttons</b>		
Load from file	Uploads a saved configuration file from the PC to the Liebert® LDMF. This feature may be used to install a backup copy of a configuration file or set up a new Liebert® LDMF installation.	<a href="#">Load a Configuration File from Disk</a> on the facing page
Install to unit	Uploads the current configuration from the PC to the Liebert® LDMF after making changes to the configuration. This step is required to update the unit with the latest changes.	<a href="#">Install Configuration Changes in the Unit</a> on the facing page
Save to file	Saves a copy of the configuration file to the PC. This feature is useful when a backup copy of the configuration file is needed.	<a href="#">Save the Configuration File to Disk</a> on page 36
Exit now	Closes the configuration program.	—

### 5.5.3 Load a Configuration File from Disk

A previously saved configuration file-created by Vertiv technical personnel or saved from a Liebert® LDMF unit-may be transferred from a PC to the Vertiv™ Liebert® LDMF.

Figure 5.12 Load a Configuration File from Disk



Item	Description
1	Load from file

This feature allows for quick setup based on another unit's configuration or replacing a configuration file in an existing installation.

#### To upload the configuration file:

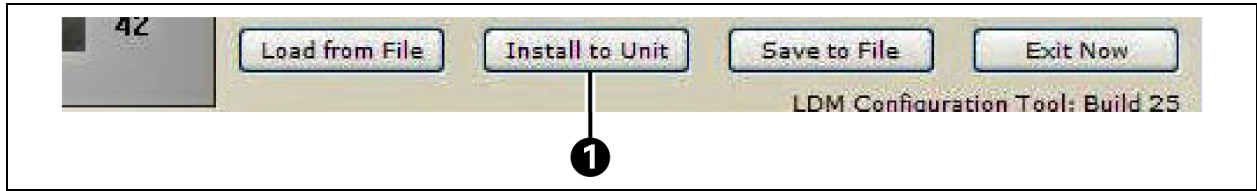
- Click on the Load from File button at the bottom of the Configuration window.
- In the Open window, navigate to the configuration file, then click Open.

After a short delay, a confirmation message appears. The Liebert® LDMF is now updated with all breaker and subfeed data from the configuration file that was just loaded.

### 5.5.4 Install Configuration Changes in the Unit

Whenever configuration changes are made using the Configuration program, the changes must be installed in the Liebert® LDMF using this procedure.

Figure 5.13 Install Configuration Changes in the Unit



Item	Description
1	Install to unit

**To install changes in the unit:**

1. Click on the Install to Unit button at the bottom of the Configuration window.
2. During the upload, the circuit board will reboot and cause a loss of communication with the monitoring products.

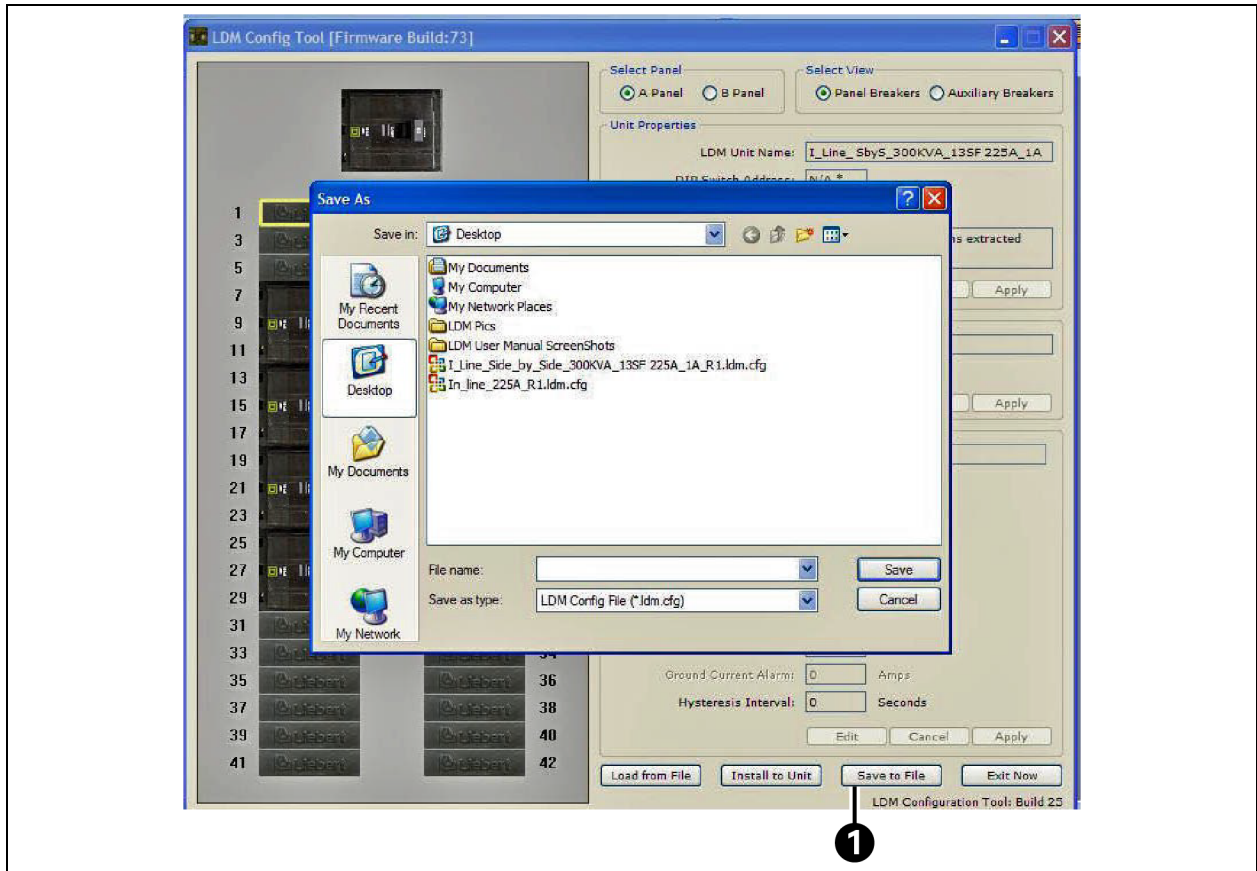
Once the rebooting process is complete, the configuration is active.

**NOTE:** Configuration changes are not stored in the Vertiv™ Liebert® LDMF until the Install to Unit button is clicked.

### 5.5.5 Save the Configuration File to Disk

Saving the configuration file creates a copy of the current configuration, ensuring a backup is available in the event of file corruption or some other problem.

Figure 5.14 Save the Configuration File to Disk





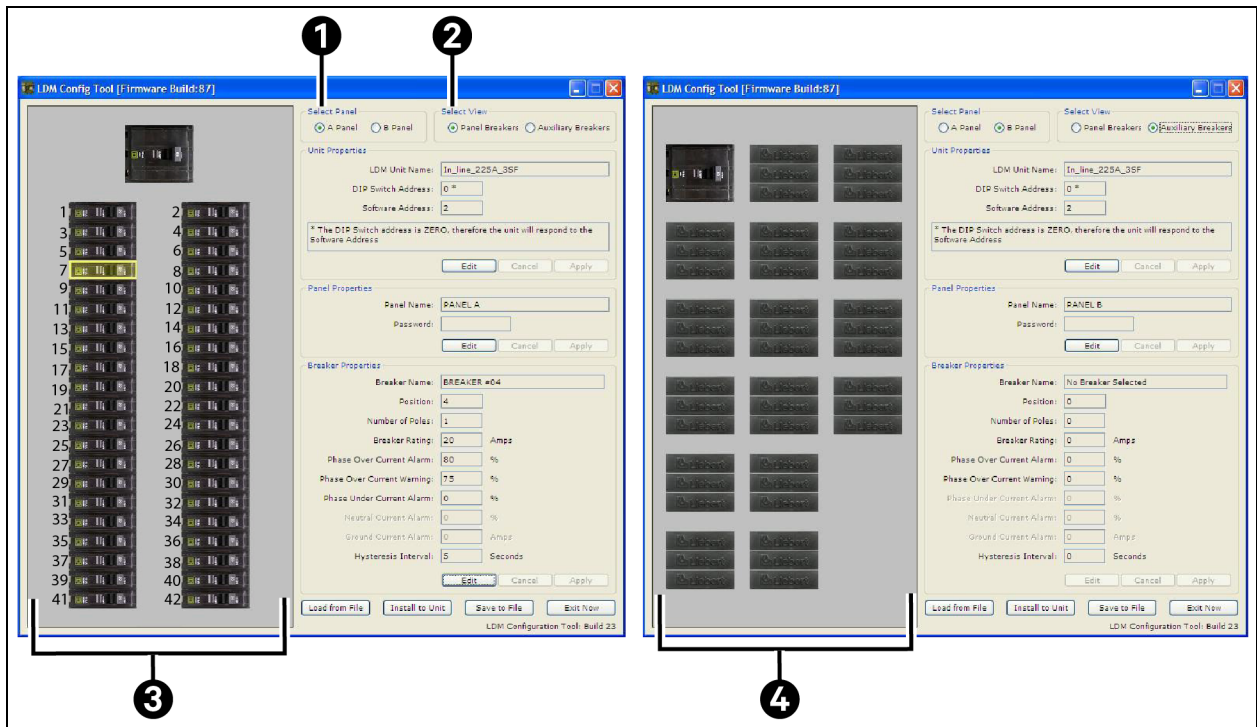
Item	Description
1	Save to file

- Click on the Save to File button at the bottom of the Configuration window.
- In the Save As window:
- Specify the location where you want to save the file in the Save In box.
- Enter a unique name in the File Name box.
- Click Save.

### 5.5.6 Select Panel to View

Up to two panelboards may be connected to the Vertiv™ Liebert® LDMF (See [Connecting Panelboards A and B](#) on page 14 ). Each may be viewed in the Configuration main window.

Figure 5.15 Select Panel to View



Item	Description
1	Select panel
2	Select view
3	Panel breakers view
4	Auxiliary breakers view

To switch the view to a different panel:

- In the Select Panel box, click on Panel A for Panelboard A or Panel B for Panelboard B. The panel name appears in the Panel Name box, as in the following examples.

### 5.5.7 Select Breakers to View

For each panelboard, two types of breakers may be configured.

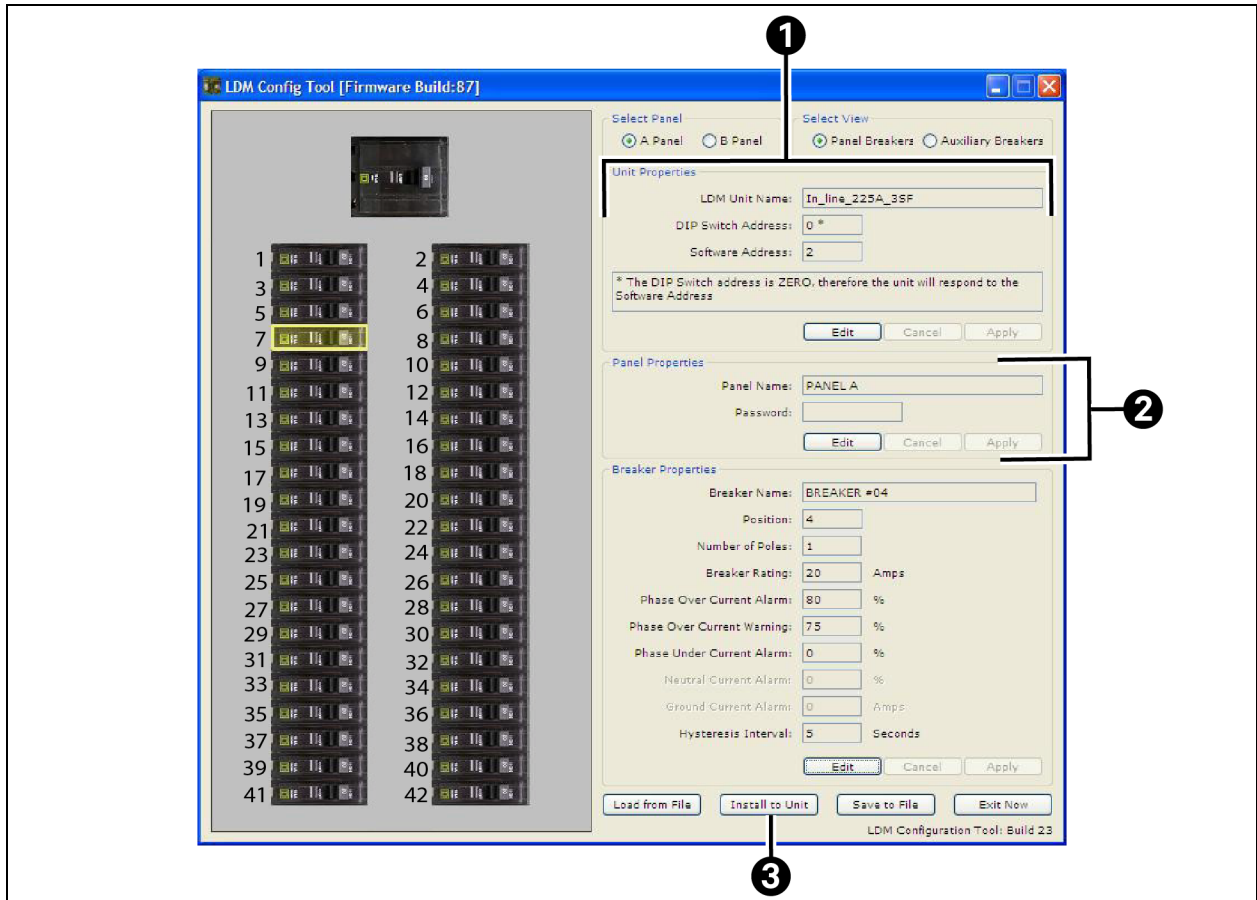
To switch the view, click on a button in the Select View box:

- Panel Breakers to view circuit breakers installed in the panelboard (See example [Panel breakers view](#) on the previous page ).
- Auxiliary Breakers to view breakers installed outside the panelboard-for example, subfeed breakers (See example [Auxiliary breakers view](#) on the previous page ).

### 5.5.8 Edit the Vertiv™ Liebert® LDMF Unit Properties

The Unit properties box displays the name and software address of the Liebert® LDMF unit:

Figure 5.16 Edit the Liebert® LDMF Unit Properties



Item	Description
1	Unit properties
2	Panel properties
3	Install to unit (click to save changes to Liebert® LDMF)

- LDMF Unit Name-a name assigned to the Liebert® LDMF unit 2

To make a change, click **Edit** and enter a name, then click **Apply**.

- Software Address - the address is configured using the communication configuration tool.
- When finished, click **Install to Unit** to upload the changes to the Vertiv™ Liebert® LDMF.

**NOTE: The configuration changes will not be stored in the Liebert® LDMF until the Install to Unit button is clicked.**

### 5.5.9 Edit the Panel Properties or Set a Password

The Panel Properties box (See **Figure 5.16** on the previous page ) displays the name of the selected panelboard, as well as a Password box for creating a password to protect against unwarranted changes to the configuration:

- Panel Name - the default panelboard names are PANEL A and PANEL B. To change a name, click **Edit** and enter a name, then click **Apply**.
- Password - a password required for users to make changes to the configuration file.

To create a password:

- a. Click in the Password box, click **Edit** and enter a password.

The password may be up to 10 characters long and may consist of any combination of numbers, letters and special characters. The password is not case-sensitive.

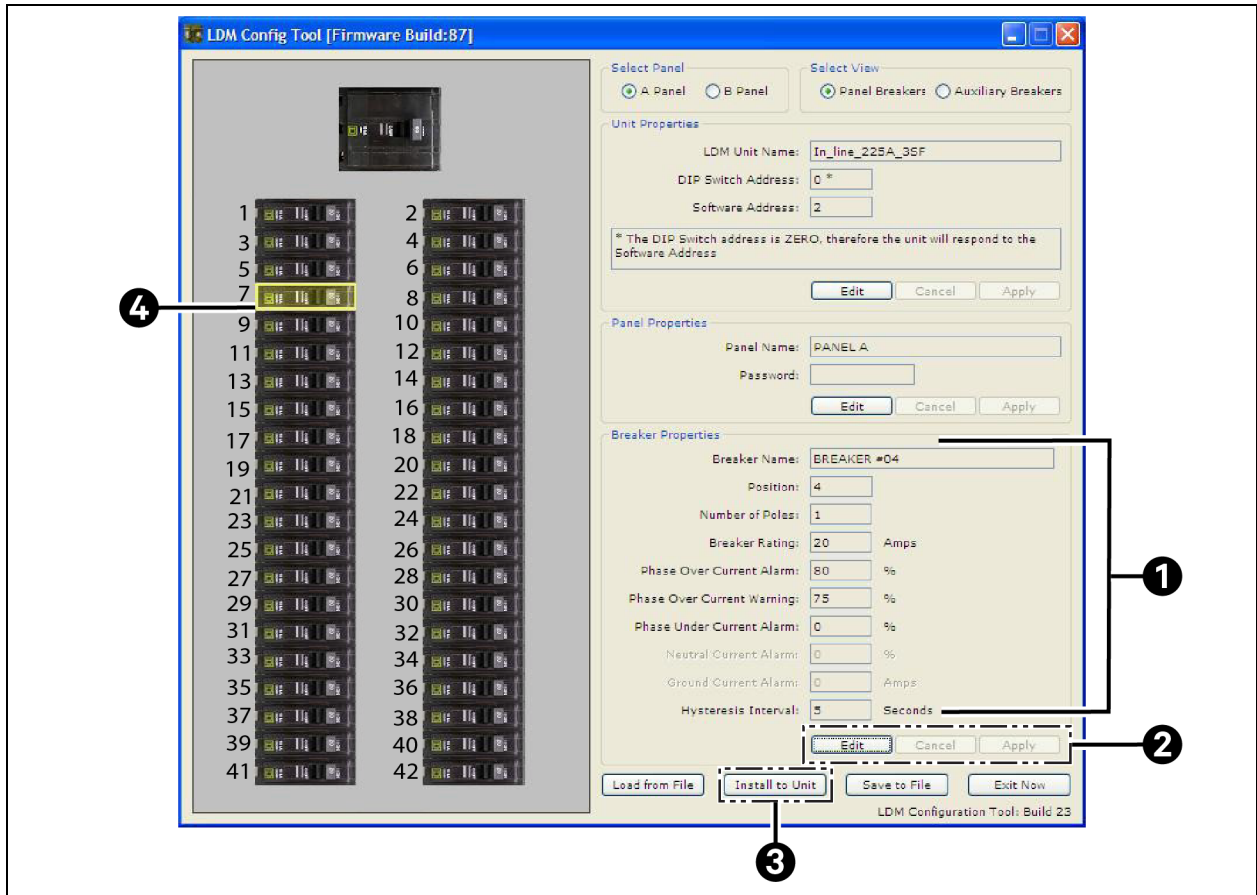
- a. Click **Apply**.
- When finished, click **Install to Unit** to upload the changes to the Liebert® LDMF.

**NOTE: The configuration changes will not be stored in the Liebert® LDMF until the Install to Unit button is clicked.**

### 5.5.10 Edit the Breaker Properties

The Breaker Properties box displays the breaker name, rating, breaker parameters and alarm settings.

Figure 5.17 Edit the Breaker Properties



Item	Description
1	Breaker properties
2	Edit and apply buttons
3	Install to unit (click to save changes to Vertiv™ Liebert® LDMF)
4	Select a breaker

**To view or change parameters and alarm settings of a breaker:**

- Click on the breaker in the left pane. When selected, the breaker has a yellow outline.
- Refer to **Table 5.6** below to make changes:

**Table 5.6 Edit Breaker Properties and Description**

Parameter	Description	To Make a Change
Breaker Name	The name of the selected breaker. The default names are BREAKER #01, BREAKER #02, etc.	Click in the breaker Name box, click Edit and enter a name, then click Apply.
Position	The location of the selected breaker on the panelboard.	(Cannot be Edited)
Number of Poles	The number of poles selected when the breaker was added to the panelboard.	(Cannot be Edited)

**Table 5.6 Edit Breaker Properties and Description (continued)**

Parameter	Description	To Make a Change
Breaker rating	The amperage for which the circuit breaker is rated. The default is 20 A.	Click in the breaker rating box, click Edit and enter a value, then click Apply.
Phase overcurrent alarm	Percentage of the breaker rating that triggers an overcurrent alarm. This value must be higher than the phase overcurrent warning.	Click in the phase overcurrent alarm box, click Edit and enter a value, then click Apply.
Phase overcurrent warning	Percentage of the breaker rating that triggers an overcurrent warning. This value must be lower than the phase overcurrent warning.	Click in the phase overcurrent warning box, click Edit and enter a value, then click Apply.
Phase undercurrent alarm	Percentage of the breaker rating that triggers an undercurrent alarm. The default is 0 (zero), which disables the alarm.	Click in the phase undercurrent box, click Edit and enter a value, then click Apply.
Neutral current alarm	Percentage of the breaker that triggers a neutral current alarm.	Click in the neutral current alarm box, click Edit and enter a value, then click Apply.
Ground current alarm	Amperage that triggers a ground current alarm.	Click in the ground current alarm box, click Edit and enter a value, then click Apply.

**NOTE: The configuration changes will not be stored in the Vertiv™ Liebert® LDMF until the Install to Unit button is clicked.**

### 5.5.11 Add a Circuit Breaker

After having an electrician physically install a circuit breaker(s) in the panelboard, use the Configuration software to add the new breaker to the configuration file.

Run the configuration program using the steps outlined in [Starting the Configuration Program](#) on page 31. Once connected, the configuration file that is currently programmed will be displayed.

**NOTE: Vertiv highly recommends saving the configuration file to the local PC as a backup before making any changes to the configuration file. Perform the steps outlined in [Save the Configuration File to Disk](#) on page 36 before proceeding.**

**NOTE: Check to make sure the location for the new breaker does NOT have a breaker already assigned. If it does, first remove that breaker assignment (See [Delete a Circuit Breaker Subfeed Breaker](#) on page 45), then return to this procedure.**

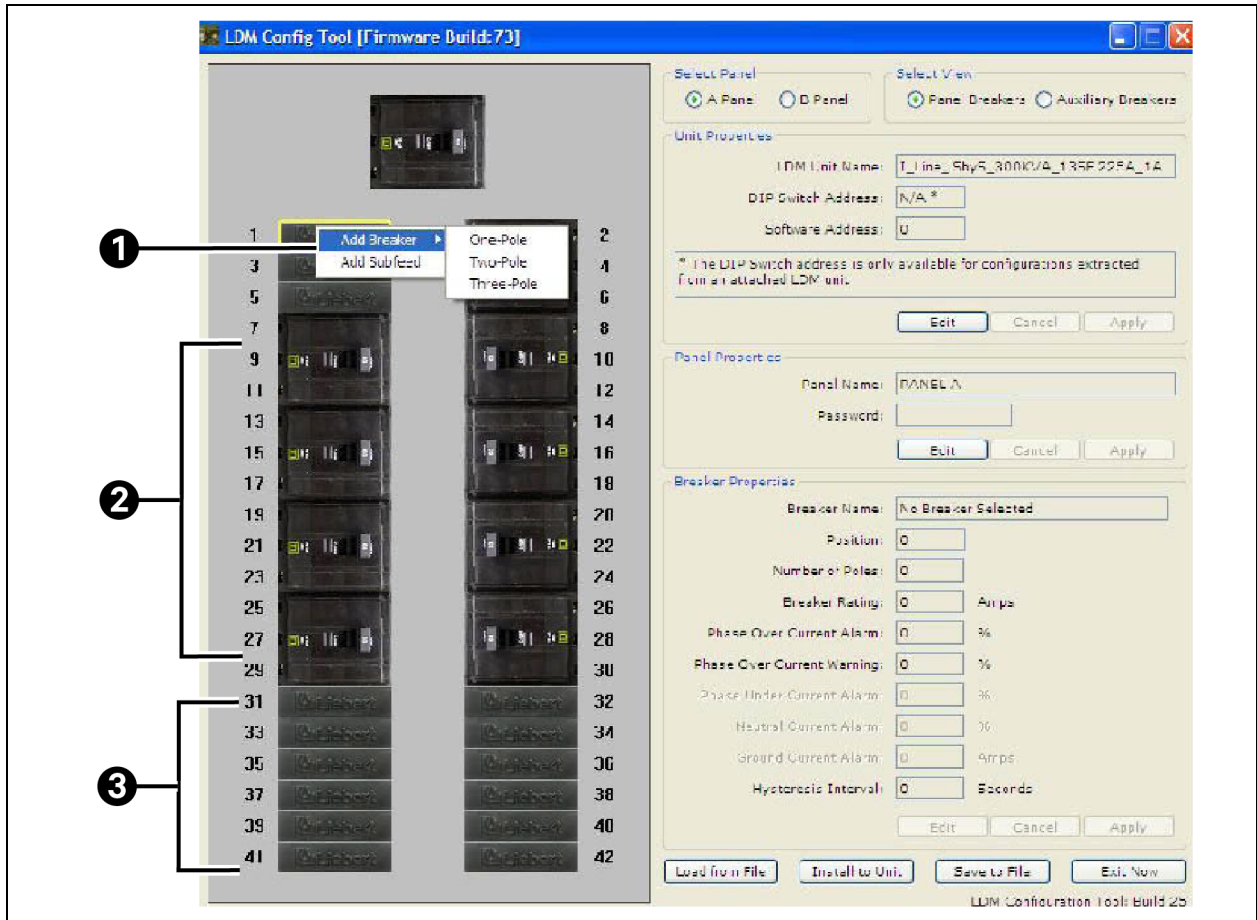
An error message appears if you attempt to add a breaker to an assigned position.

- If NOT assigned, a breaker position is shown with a Liebert logo.
- An assigned breaker position appears as a picture of a circuit breaker.

#### To add a 1-, 2- or 3-pole circuit breaker:

- Run the Configuration program (See [Starting the Configuration Program](#) on page 31).
- If needed, select the panel and breaker view with the new breaker:
  - a. In the Select Panel box, click on Panel A or Panel B depending on the panelboard where the new breaker was added.
  - b. In the Select View box, choose Panel Breakers if the new breaker is installed inside the panelboard (branch breaker) or Auxiliary Breakers if located outside the panelboard (subfeed/output breaker).

Figure 5.18 Add a Circuit Breaker



Item	Description
1	Add breaker
2	Assigned breaker positions
3	Unassigned breaker positions

- Right-click on the new breaker position in the left pane. The selected breaker has a yellow outline.
- In the pop-up menu, click on Add Breaker and then click on the type of breaker that was installed: 1-Pole, 2-Pole or, 3-Pole.
- In the Breaker Properties at right, change the breaker’s name, parameters and alarm settings as needed (See [Edit the Breaker Properties](#) on page 39).
- When finished, click Install to Unit to upload the changes to the Vertiv™ Liebert® LDMF.

**NOTE:** The configuration changes will not be stored in the Liebert® LDMF until the Install to Unit button is clicked.

## 5.5.12 Adding a Subfeed Breaker

**NOTE:** Check to make sure the location for the new breaker does NOT have a breaker already assigned. If it does, first remove that breaker assignment (See [Delete a Circuit Breaker Subfeed Breaker](#) on page 45 ), then return to this procedure.

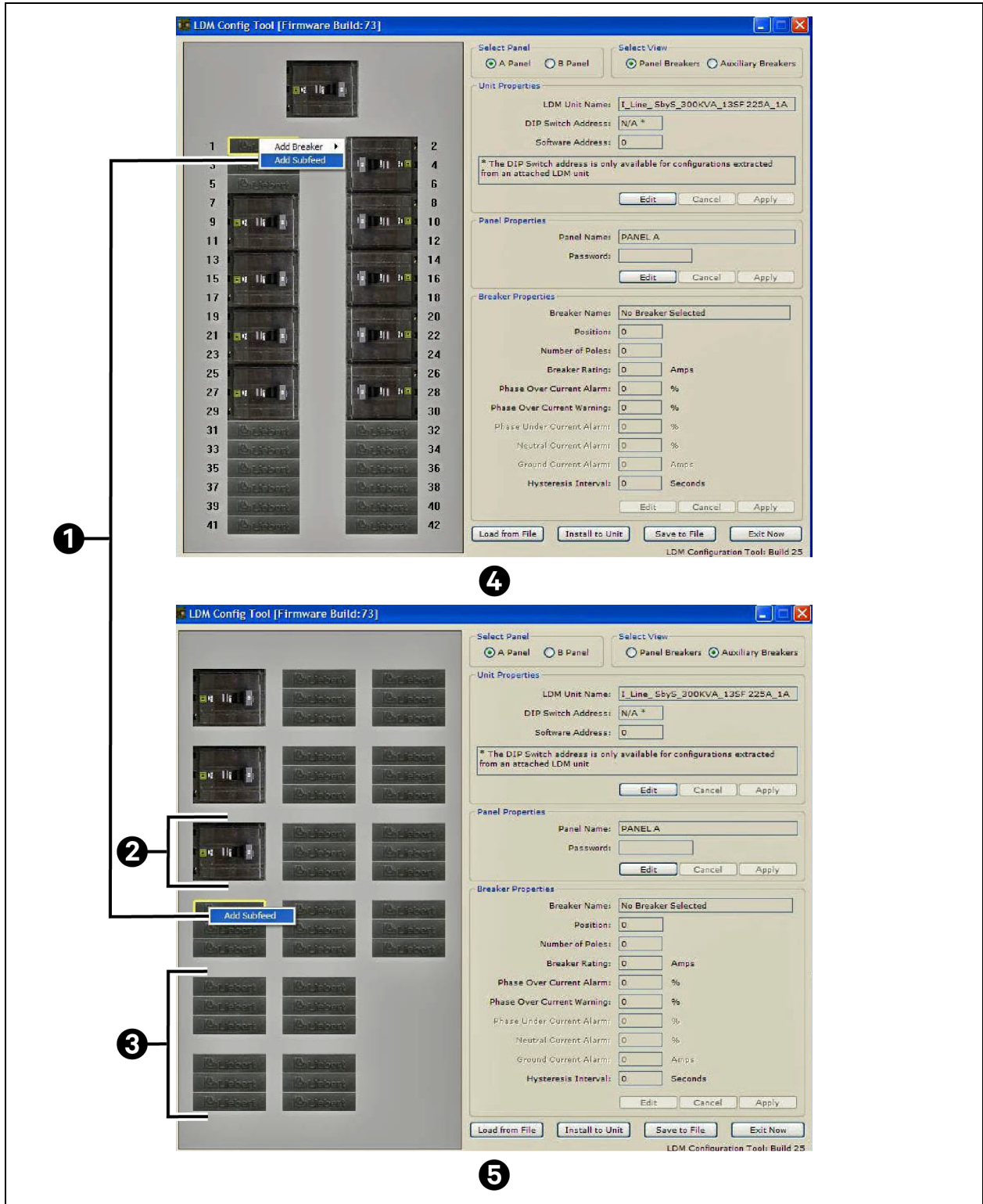
An error message appears if you attempt to add a breaker to an already assigned position.

- If NOT assigned, a subfeed breaker position is shown with three Liebert logos.
- An assigned subfeed breaker position appears as a picture of a 3-pole breaker.

### To add a 3-pole subfeed breaker circuit:

- Run the Configuration program (See [Starting the Configuration Program](#) on page 31 ).
- If needed, select the panel and breaker view with the new breaker:
  - a. In the Select Panel box, click on Panel A or Panel B.
  - b. In the Select View box, choose Panel Breakers if the new breaker is installed inside the panelboard or Auxiliary Breakers if it is located outside the panelboard.

Figure 5.19 Adding a Subfeed Breaker

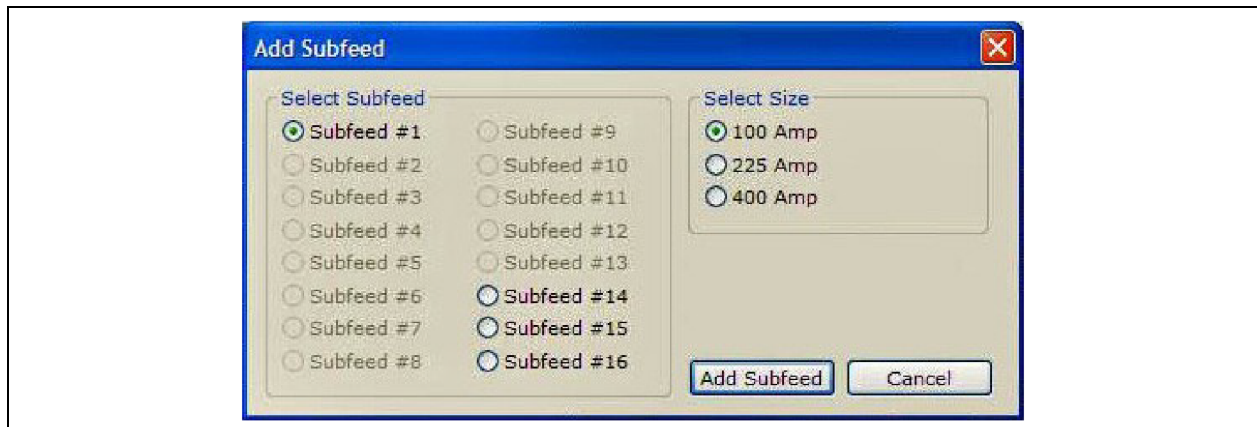




Item	Description
1	Add subfeed
2	Assigned breaker positions
3	Unassigned breaker positions
4	Panel breaker view
5	Auxiliary breaker view

- Right-click on the new breaker position in the left pane. The selected breaker has a yellow outline 4.
- In the pop-up menu, click on Add Subfeed.
- In the Add Subfeed window:
  - a. Click on the subfeed- for example, Subfeed #1 or Subfeed #2- in the Select Subfeed box.

**Figure 5.20 Add Subfeed**



**NOTE: The number of available subfeeds is determined by the interface board selected and whether cross-configuration is enabled.**

- b. In the Select Size box, choose the rating of the new breaker: 100 Amp, 225 Amp or 400 Amp.
  - c. Click on the Add Subfeed button to return to the main Configuration window.
- In the Breaker Properties box of the Configuration window, change the subfeed breaker's name, parameters and alarm setpoints as needed (See [Edit the Breaker Properties](#) on page 39 ).
  - When finished, click Install to Unit to upload the changes to the Vertiv™ Liebert® LDMF.

**NOTE: The configuration changes will not be stored in the Liebert® LDMF until the Install to Unit button is clicked.**

### 5.5.13 Delete a Circuit Breaker Subfeed Breaker

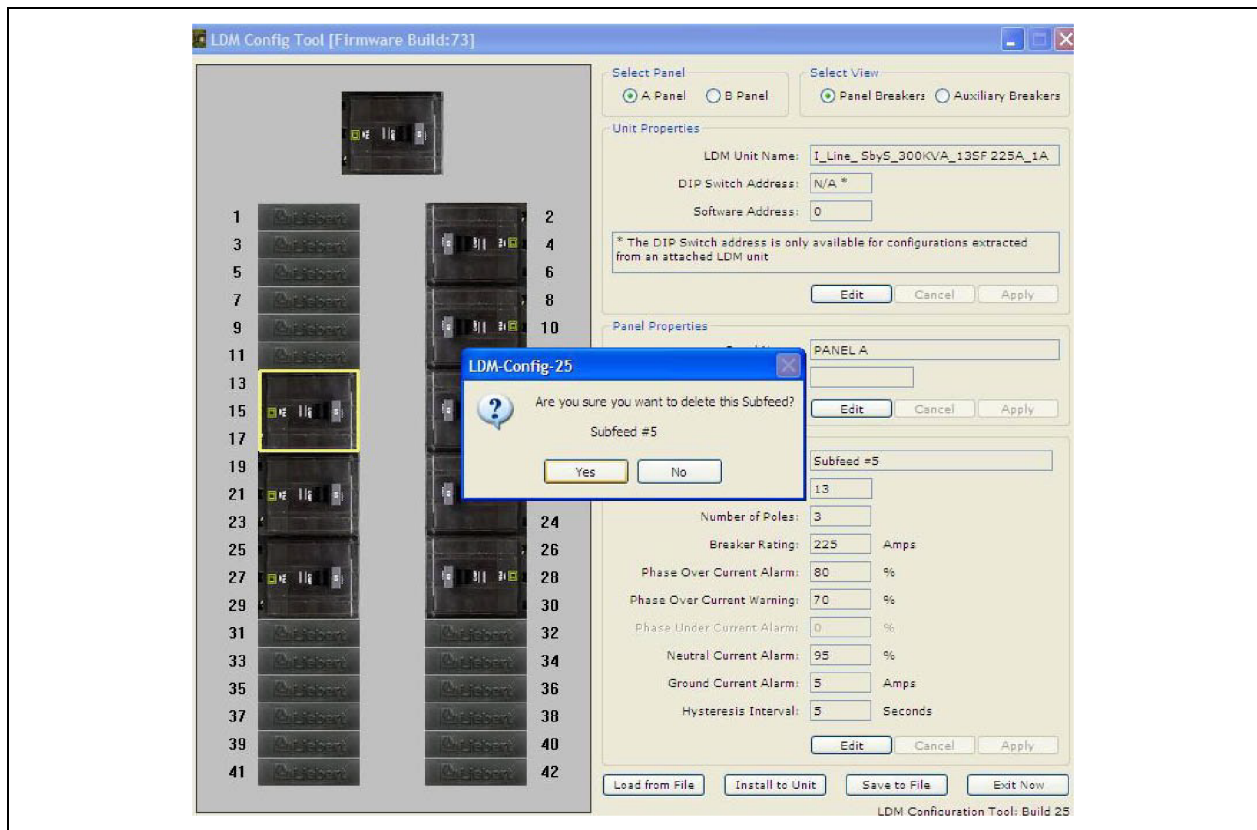
Removing a breaker from the configuration is required after moving or removing circuit breakers in the panelboard. This step must be performed before adding a breaker in the same position.

**To delete a breaker:**

- Run the Configuration program (See [Starting the Configuration Program](#) on page 31 ).
- If needed, select the panel and breaker view with the breaker to be deleted:
  - a. In the Select Panel box, click on Panel A or Panel B.

- b. In the Select View box, choose Panel Breakers if the breaker is installed inside the panelboard or Auxiliary Breakers if located outside the panelboard.

**Figure 5.21 Delete a Circuit Breaker Subfeed Breaker**



- Right-click on the breaker position in the left pane. The selected breaker has a yellow outline.
- In the pop-up menu, click Delete.
- A confirmation message appears, as shown above. Select Yes to delete the breaker (or No to cancel).
- Repeat as needed to delete other breakers.
- When finished, click Install to Unit to upload the changes to the Vertiv™ Liebert® LDMF.

**NOTE: The configuration changes will not be stored in the Liebert® LDMF until the Install to Unit button is clicked.**

## 5.6 Upgrading the Firmware

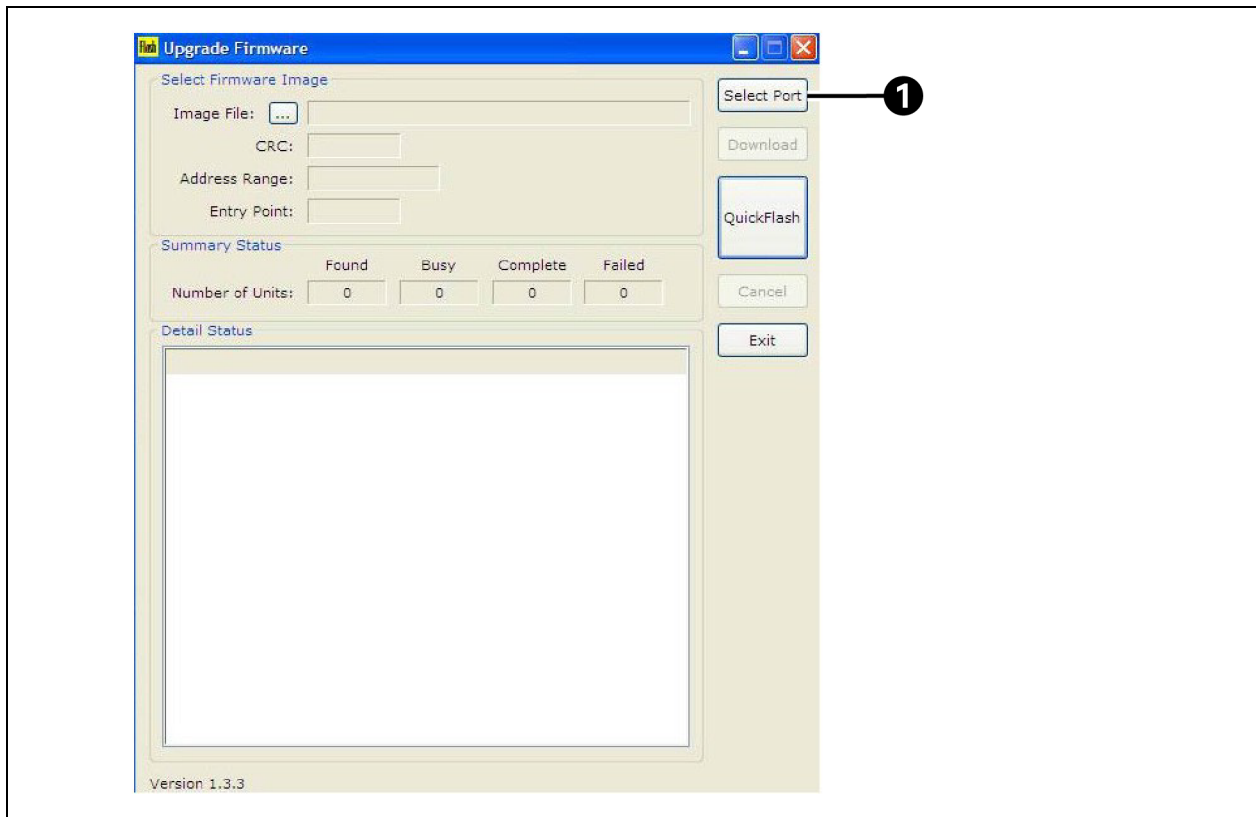
The Flash program is used to upgrade the firmware on a Liebert® LDMF unit. It uses the service terminal port to erase the old firmware, copy the new firmware and reboot the unit.

**NOTE: Updating the firmware will not erase any configuration settings currently installed. Installing a new configuration file will overwrite the Modbus address and settings.**

### To upgrade the firmware:

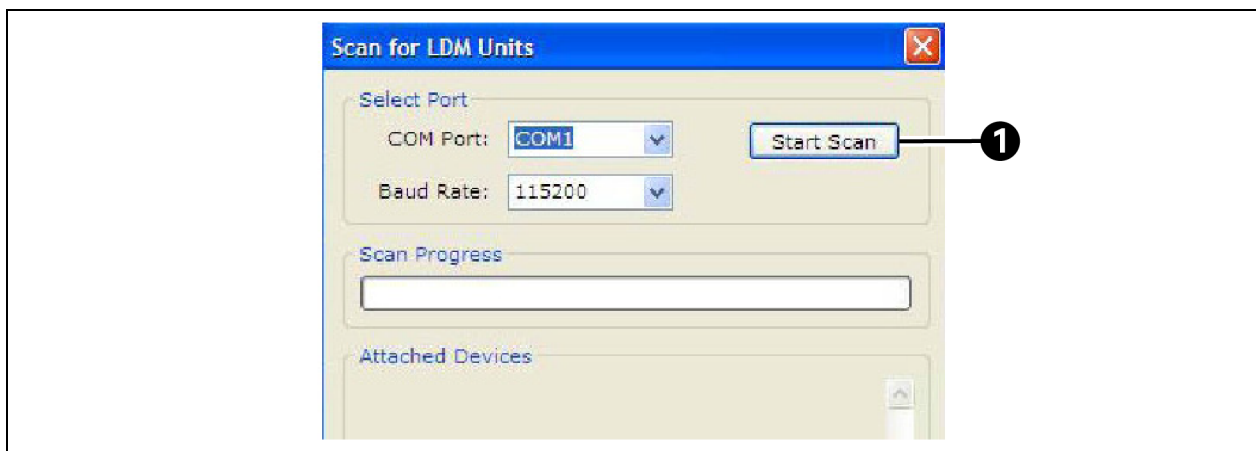
1. Make sure the Liebert® LDMF unit is powered ON.
2. Connect the PC to the Liebert® LDMF via the external DB9 connection. Refer to [LDMF Setup Port Connection](#) on page 25.
3. Run the file named Flash-x.x.x.exe (where x.x.x is the version number).

4. In the Upgrade Firmware window, click the Select Port button.



Item	Description
1	Select port

5. In the Scan for LDM Units window:
- Select the COM port from the drop-down list-for example, COM1.
  - Make sure the baud rate is 115200.
  - Click the Start Scan button to check for a connection to the unit.



Item	Description
1	Start scan button

6. If the Vertiv™ Liebert® LDMF unit is detected, a confirmation window appears. Click Yes to continue and proceed to [Step 7](#).

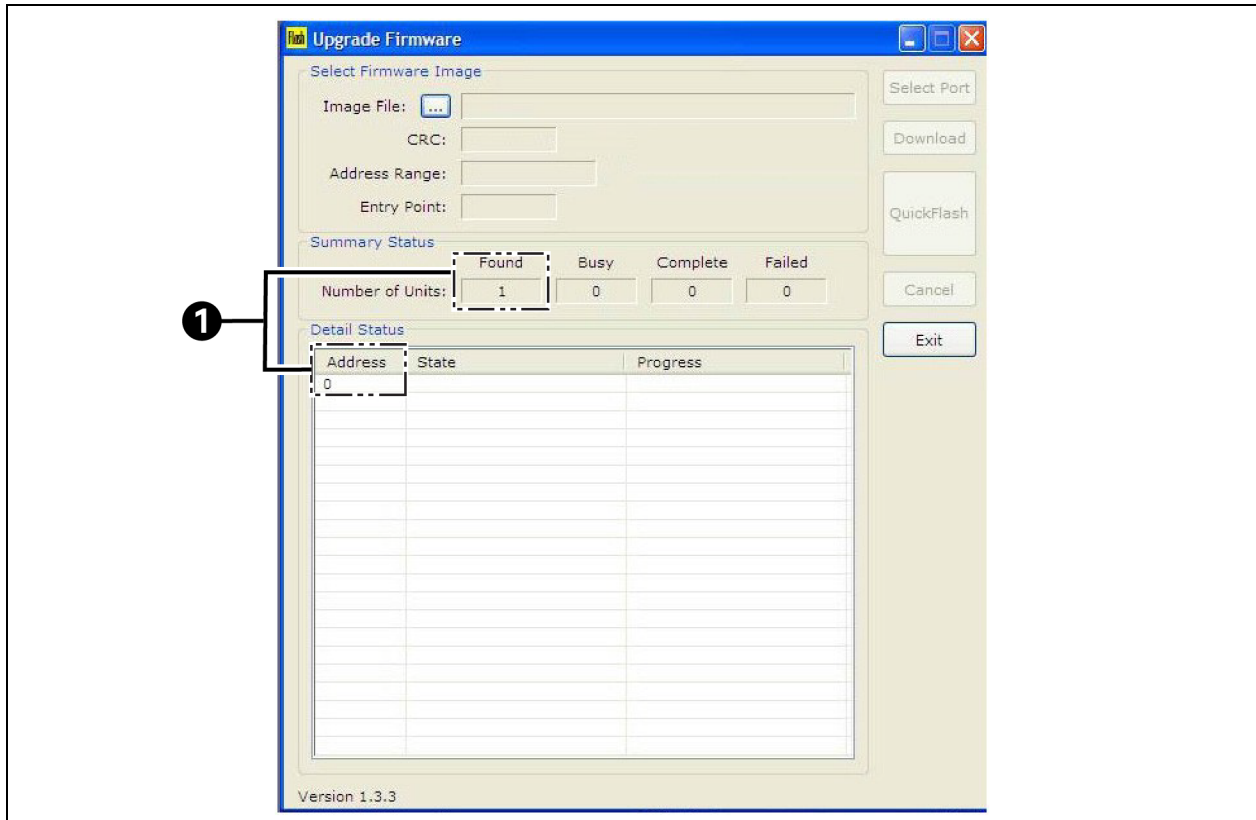


If the Liebert® LDMF unit is NOT detected, an error message appears. Click OK to return to the Upgrade Firmware window. Check to verify the following, then repeat [Step 5](#):


- The correct COM Port is selected and the baud rate is 115200.
- A serial cable is properly connected to the unit ([LDMF Setup Port Connection](#) on page 25).
- The Liebert® LDMF unit is powered ON.

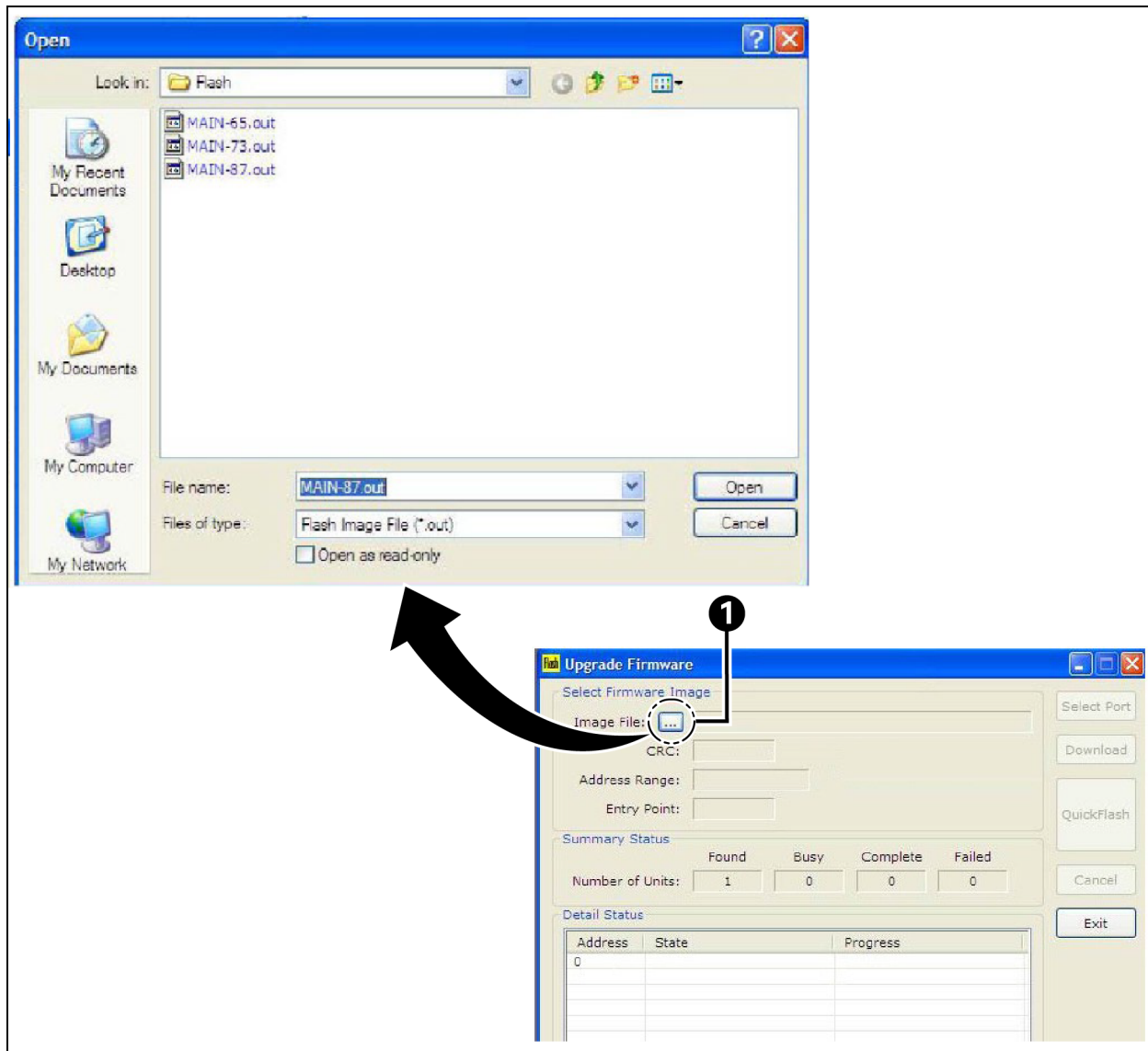


7. Verify the Upgrade Firmware window displays the following indications that the connection was successful (shown in the example below):
- In the Summary Status box, the Number of Units should be 1 in the Found box.
  - In the Detail Status box, 0 should appear in the Address column.
  - The Select Port, Download, Quick Flash, and Cancel buttons are grayed-out.



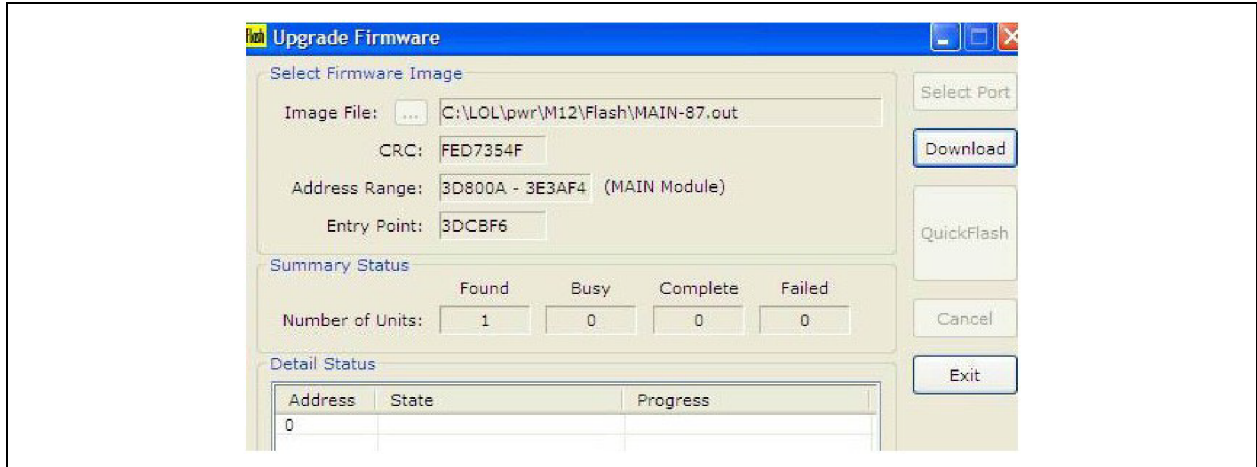
Item	Description
1	Connection successful

8. Click the Image File button , and the Open window appears.
- Browse to the folder where the Flash files are located-this should be the same folder where the Flash program was installed.
  - Select the file you want to download.
  - Click the Open button.



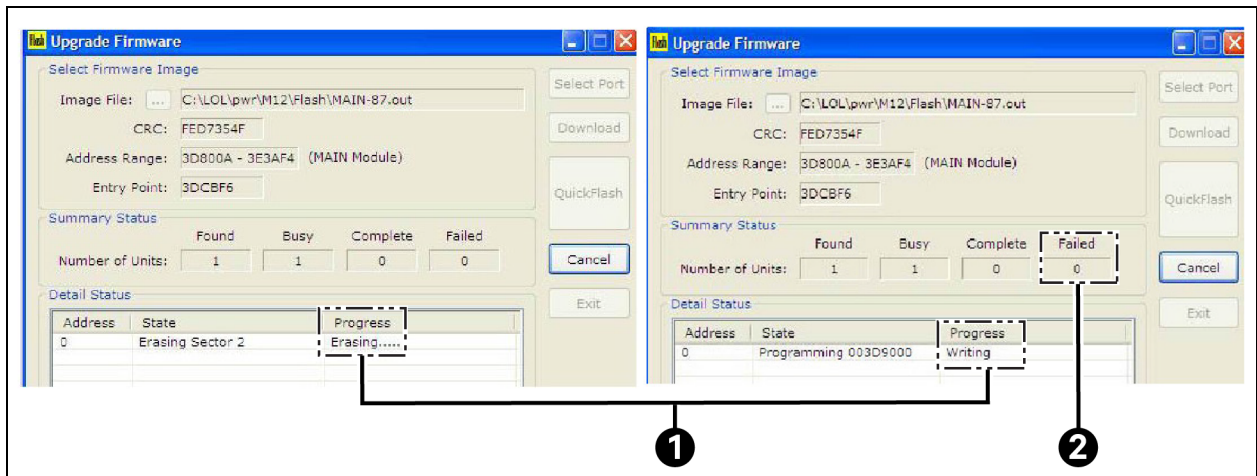
Item	Description
1	Image file button navigate to file

9. The Upgrade Firmware window appears. Click the Download button to continue.



10. Wait for the firmware upgrade to complete. The Progress column in the Detail Status Area shows the status of the upgrade.

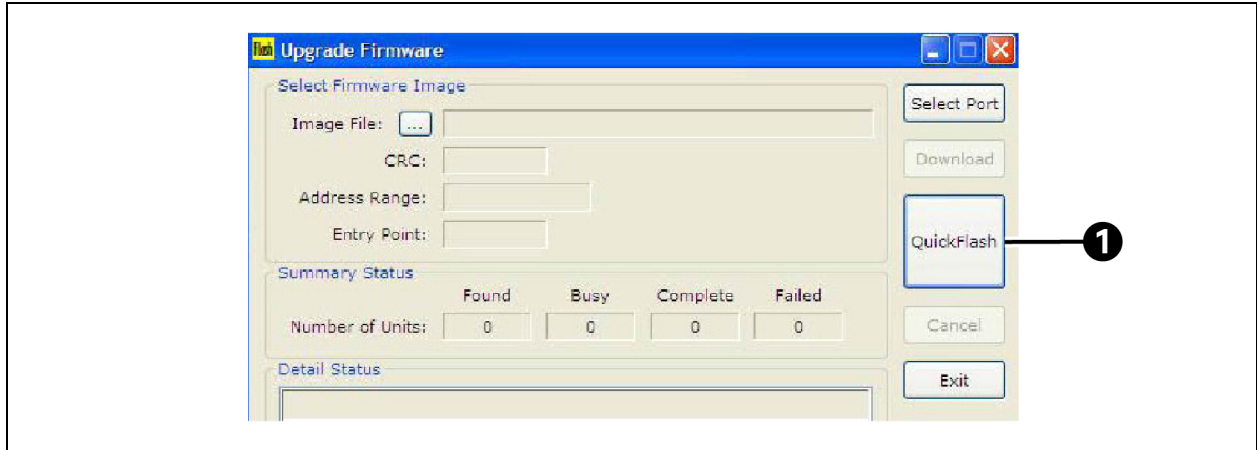
The program erases the old image (below), then writes the new image (below).



Item	Description
1	Progress column
2	Failed = 0

11. When the new image is loaded, the Flash program restarts the unit. Verify the following:
- In the Summary Status box, the Number of Units should be 0 under Failed (above right).
  - In the Detail Status box, Running should appear in the Progress column-this indicates that the BCB has been restarted successfully.
12. The Flash program has a Quick Flash feature that keeps track of where the file is stored on the local PC. This feature becomes active after the initial firmware update has been completed. This makes upgrading numerous LDMF Systems easier and less time-consuming.

Connect to each additional LDMF System, then click on the QuickFlash button to begin the update automatically without having to specify the file location.



Item	Description
1	Quick flash button

13. Once all LDMF Systems have been upgraded, click Exit to close the Flash program.

## 5.7 Display Controls (Legacy HMI)

The Vertiv™ Liebert® LDMF displays panelboard data via a local display in conjunction with the remote capabilities. This display gives the end user a quick and easy way of viewing the panelboard branch circuit breaker currents, panelboard voltages, alarms and status. An audible alarm is also provided in the event that any programmed alarm threshold is exceeded.

The user interface and menu selections have been developed to make it easy to scroll through panelboard data points with clearly labeled variable function keys. These function keys change features depending on the menu selected to maintain a clearly visible view area.

There can be up to two HMIs on a unit and each can display up to four panelboards.

### 5.7.1 Controls and Indicators

The left side of the display includes indicators and an alarm speaker:

- Power Indicator (Green LED)-illuminates when power has been applied to the Liebert power product.
- Alarm Status Indicator (Red LED-illuminates when the Vertiv™ Liebert® LDMF detects an alarm. The audible alarm will also sound until the Silence/Reset push button is depressed. The LED will remain illuminated until the alarm condition is cleared.
- Audible Alarm speaker (represented by the white dot)-a speaker behind the bezel will sound when the Liebert® LDMF records an alarm condition. Pressing the Silence/Reset push button mutes the audible alarm until another alarm is generated or the alarm condition has cleared.

The middle section includes the display area and navigation keys to change the display:

- LCD viewing area - displays parametric or alarm data for selected components.
- Navigation keys (soft function keys F1 through F4 and Help)-some of these keys vary in function, as indicated in the text description above each key:
  - a. F1 selects the next major item such as Next Main, Next Subfeed, or Next Branches.
  - b. F2 is the Sequence key. It selects the next set of items at the current level or the next item on a list.
  - c. F3 can select Subfeeds at the top level or can select a menu item at lower levels.



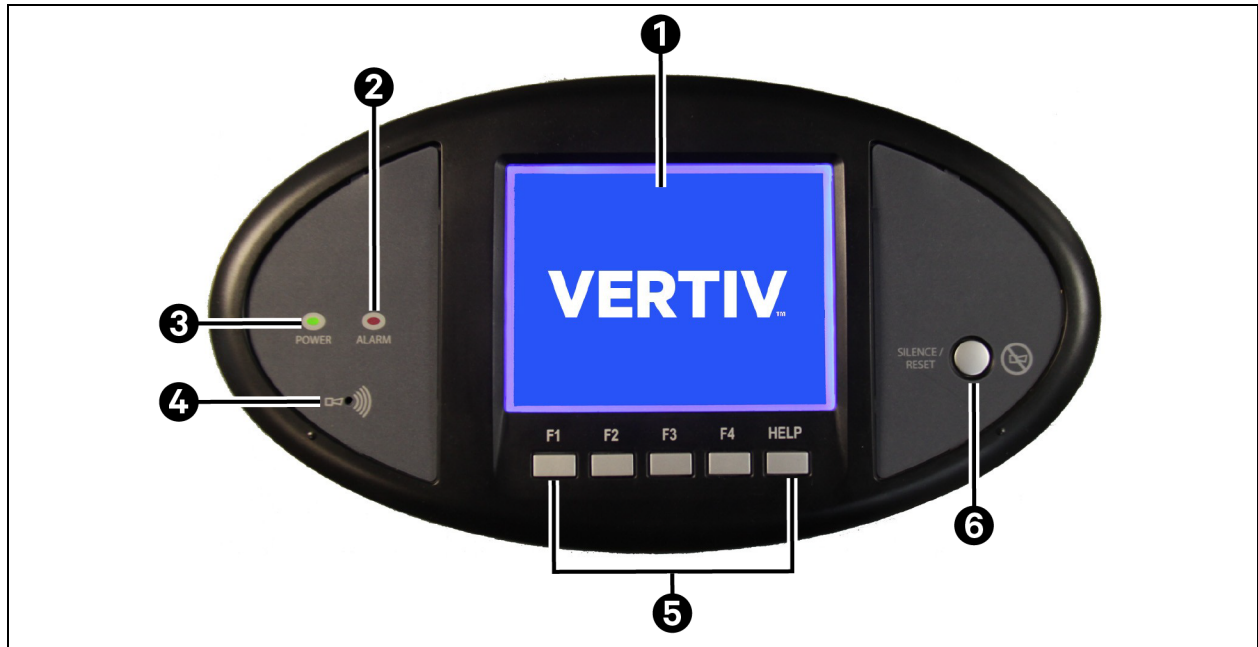
- d. F4 can select Branch Breakers at the top level or provide a Back function at lower levels.

Pressing the Back key (F4) navigates to the top level (Main) except from the Help screen. From the Help screen, the Back key navigates to the previous screen.

- a. Pressing the Help key navigates to the Help screen.

At right is the alarm Silence/Reset button:

- a. Press the Silence/Reset button once and hold to silence the audible alarm.
- b. Press the Silence/Reset button a second time to clear the alarm and turn Off the red LED.



Item	Description
1	LCD viewing area
2	Alarm status indicator red
3	Power indicator green
4	Audible alarm speaker
5	Navigation keys
6	Alarm silence/reset push button

## 5.7.2 Vertiv™ Liebert® LDMF Parameter Screens

Three types of parameter screens may be selected from the Main Screen by pressing the soft keys labeled Next Main, Subfeeds and Branch Breakers to display the applicable information.

Figure 5.22 Liebert® LDMF Parameter Screens



Item	Description
1	Next main
2	Subfeeds
3	Branch breakers

### Next Main

Press the Next Main key to display parameters for the main breaker feeding power to a panelboard. There may or may not be a physical circuit breaker installed. The Next Main key toggles between the two Main Panelboard breakers in a Liebert Power product with more than one panelboard.

### Subfeeds

Press the Subfeeds key to show parameters for subfeed breakers-these are usually circuit breakers that feed remote circuits or panelboards. They may reside as separate entities within a Liebert Power product or a special large panelboard.

### Branch Breakers

Press the Branch Breakers key to view parameters for 1-, 1- or, 3pole circuit breakers that reside in the panelboard. The branch data resides at the lowest level except for the alarm summary.

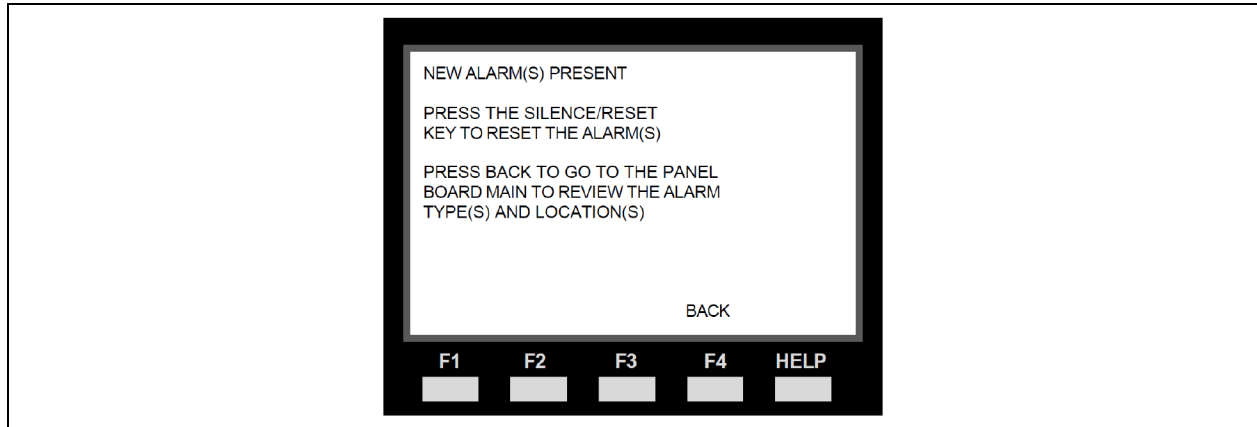
## 5.7.3 Vertiv™ Liebert® LDMF Alarms

If any alarms are present when parameter screens are accessed with the Main, Subfeeds or Branch Breakers keys, the Alarm Screen appears, as shown in the example below.

- Press F4 (Back) to view details about the alarm on the Panelboard Main screen.
- The alarm activates the Audible Alarm and the red Alarm LED.

- Press the Silence/Reset key once to silence the audible alarm.
- Press the Silence/Reset key a second time to clear the alarm. If all alarms are reset, the display returns to the Main Alarm screen.
- If the alarm condition persists, a new alarm is generated and the sequence is repeated.

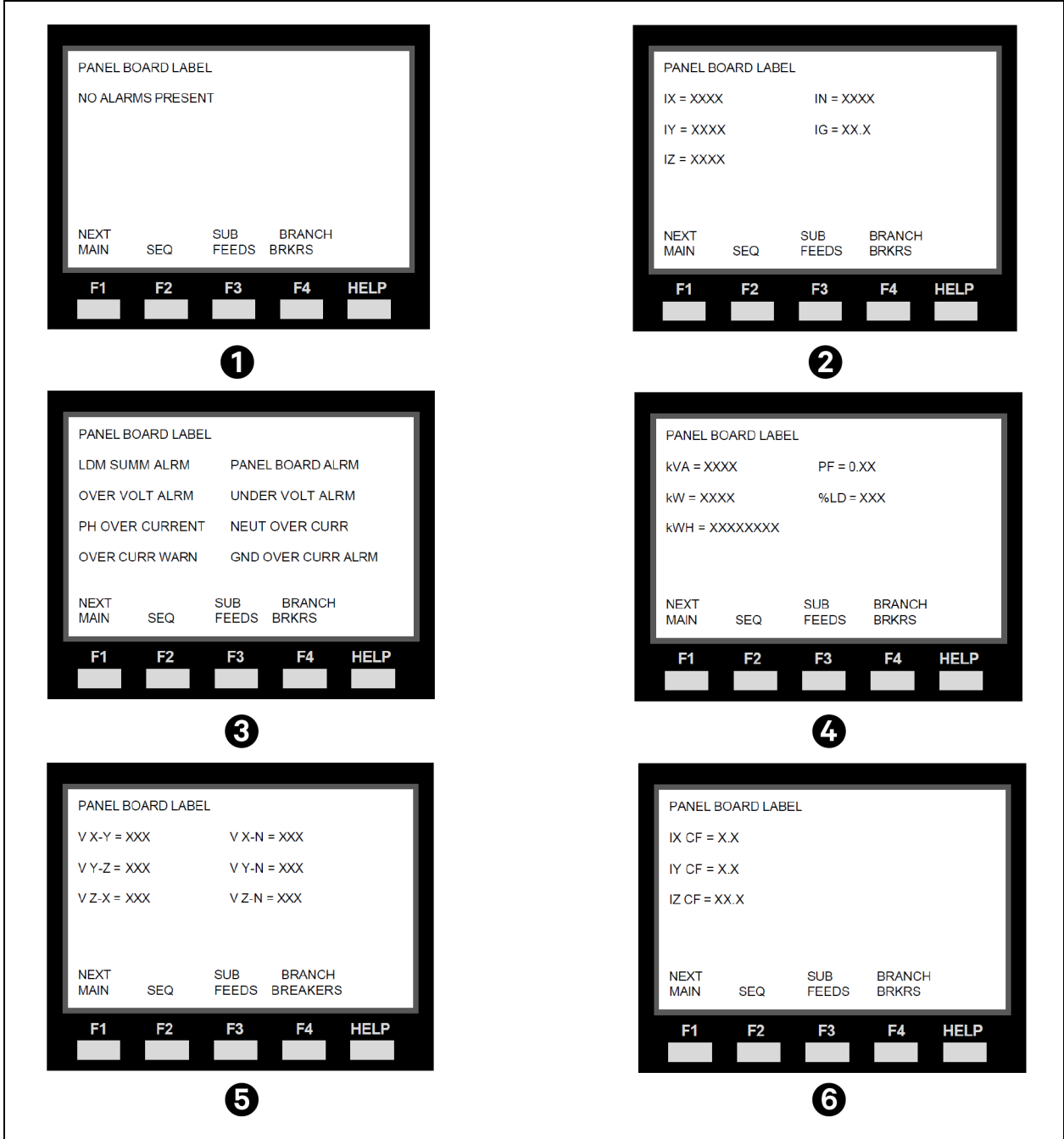
**Figure 5.23 Liebert® LDMF Alarms**



### 5.7.4 Vertiv™ Liebert® LDMF Screens

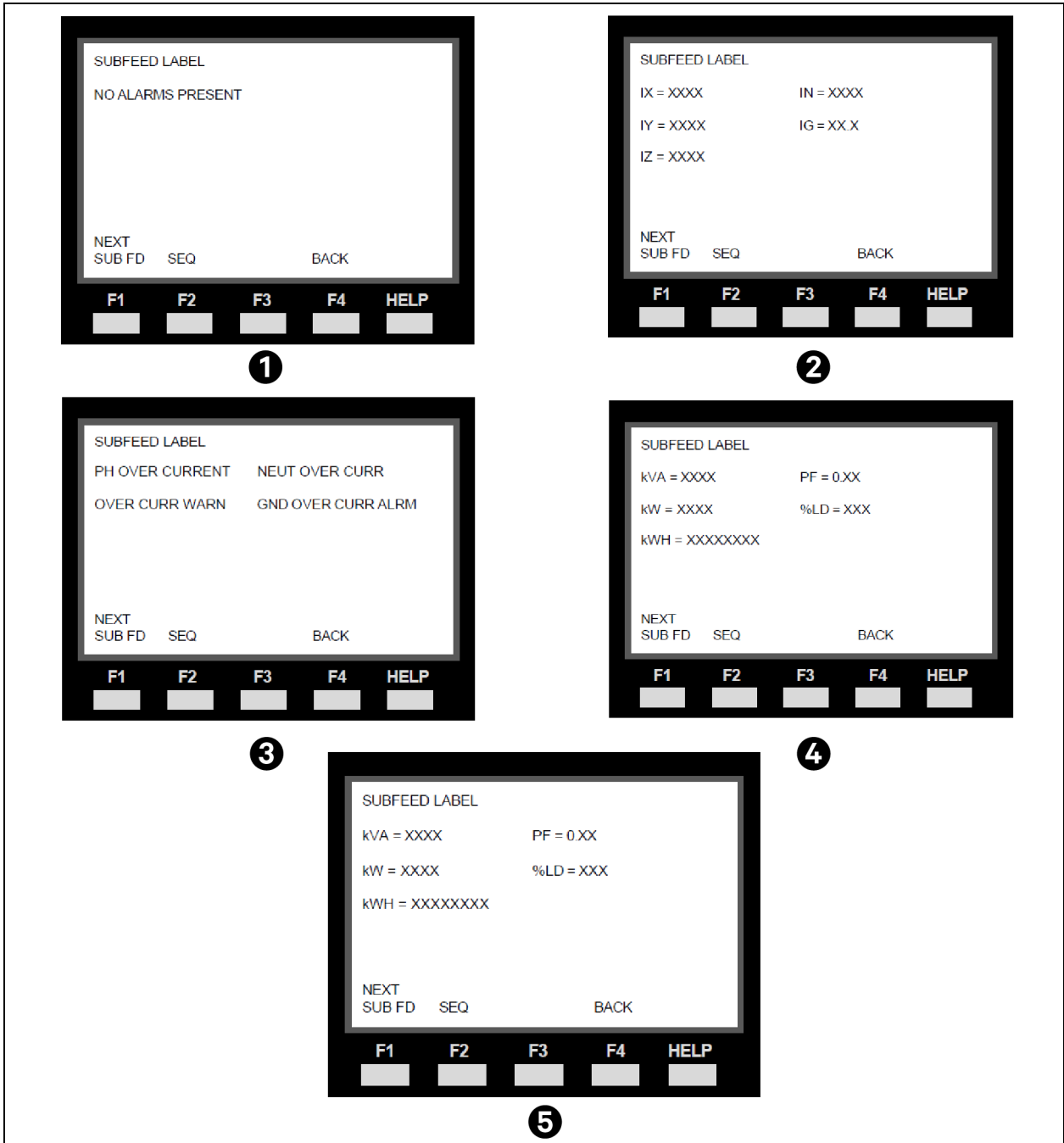
**NOTE:** The images below are for representation of the menu items only. The actual display including the Controls and Indicators shown in the images below may not be present.

Figure 5.24 Main Panelboard Screens-Examples



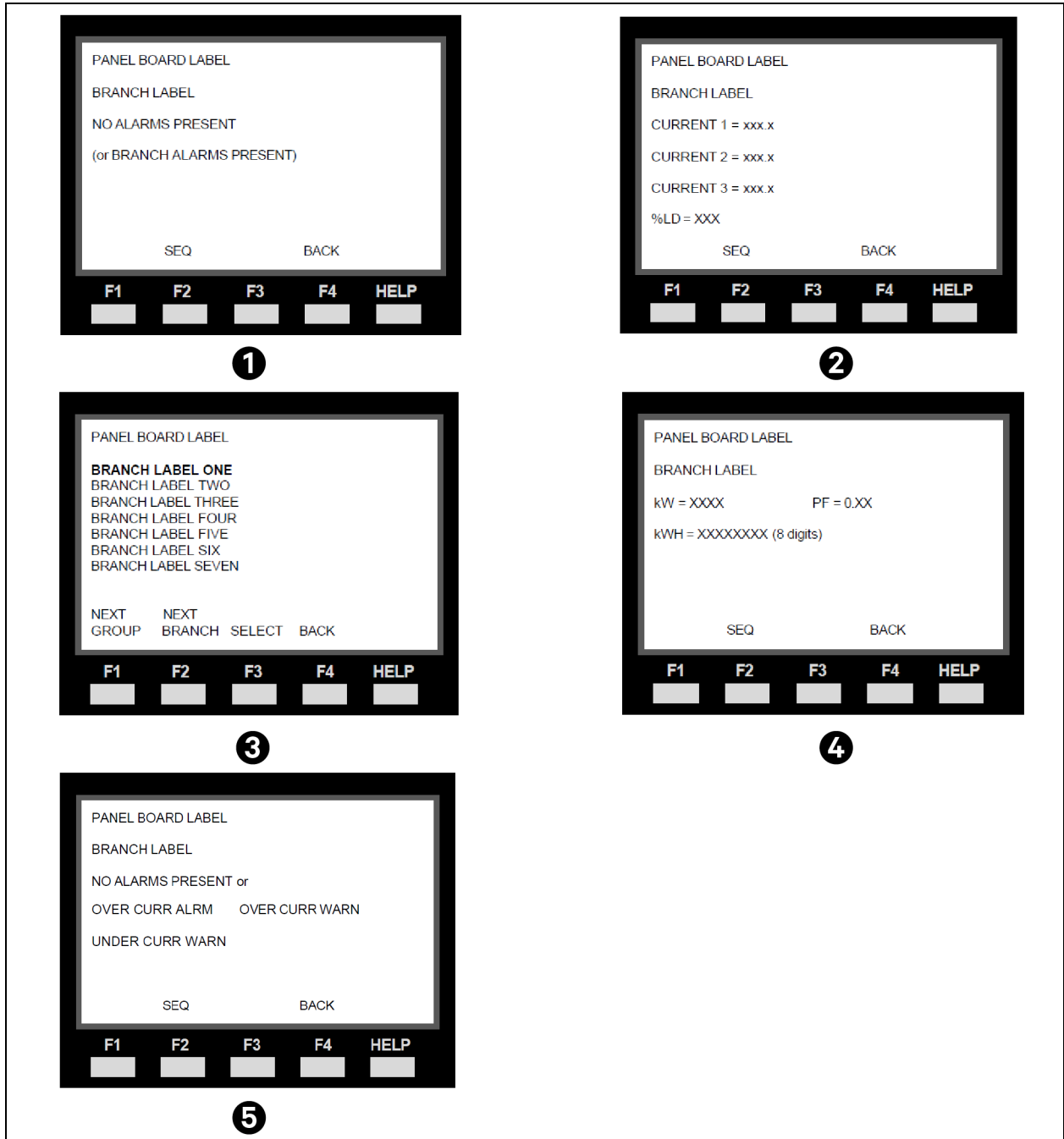
Item	Description
1	Panelboard main screen (if no alarms are present)
2	Panelboard currents
3	Panelboard alarms (appears only if alarms are present)
4	Panelboard power values
5	Panelboard voltages
6	Panelboard crest factor (CF)

Figure 5.25 Subfeed Screens-Examples



Item	Description
1	Subfeed main screen (if no alarms are present)
2	Subfeed current
3	Subfeed alarms (appears only if alarms are present)
4	Subfeed power values
5	Subfeed crest factor (CF) & THD

Figure 5.26 Branch Breaker Screens-Examples



Item	Description
1	Branch breaker main screen (if no alarms are present)
2	Branch current
3	Branch breakers
4	Branch power values
5	Branch alarms

## 5.8 Display and Controls (Current HMI)

The Vertiv™ Liebert® LDMF displays panelboard data via a local display in conjunction with the remote capabilities. This display gives the end user a quick and easy way of viewing the panelboard branch circuit breaker currents, panelboard voltages, alarms and status. An audible alarm is also provided when an alarm activates.

The Touchscreen Control Panel's integrated interface simplifies monitoring and managing the PDU or RPP where it is installed. The LDMF interface will display data either graphically or as text, whichever the user chooses. The display alternates between graphics and text at the touch of an icon. The one-line diagram remains displayed and interactive, even when text view is chosen. The toolbar at the top of the touchscreen summarizes system conditions with colors and an icon matched to the status. The color and the icon change immediately if the system's status changes. The right panel displays meters showing data about the output side of the transformer. The upper portion of the panel has the overall status. Below that is detailed output data for each phase. (See **Figure 5.27** on the facing page )

This HMI can display data from one or two panelboards.

### 5.8.1 Touchscreen Control Panel and User Interface

The LDMF HMI uses graphical icons or text to show the comprehensive information that the operator needs to keep the system operating smoothly and efficiently:

- Is input power connected?
- Is the load balanced?
- Are there any alarms?
- Which breakers are open and which are closed?

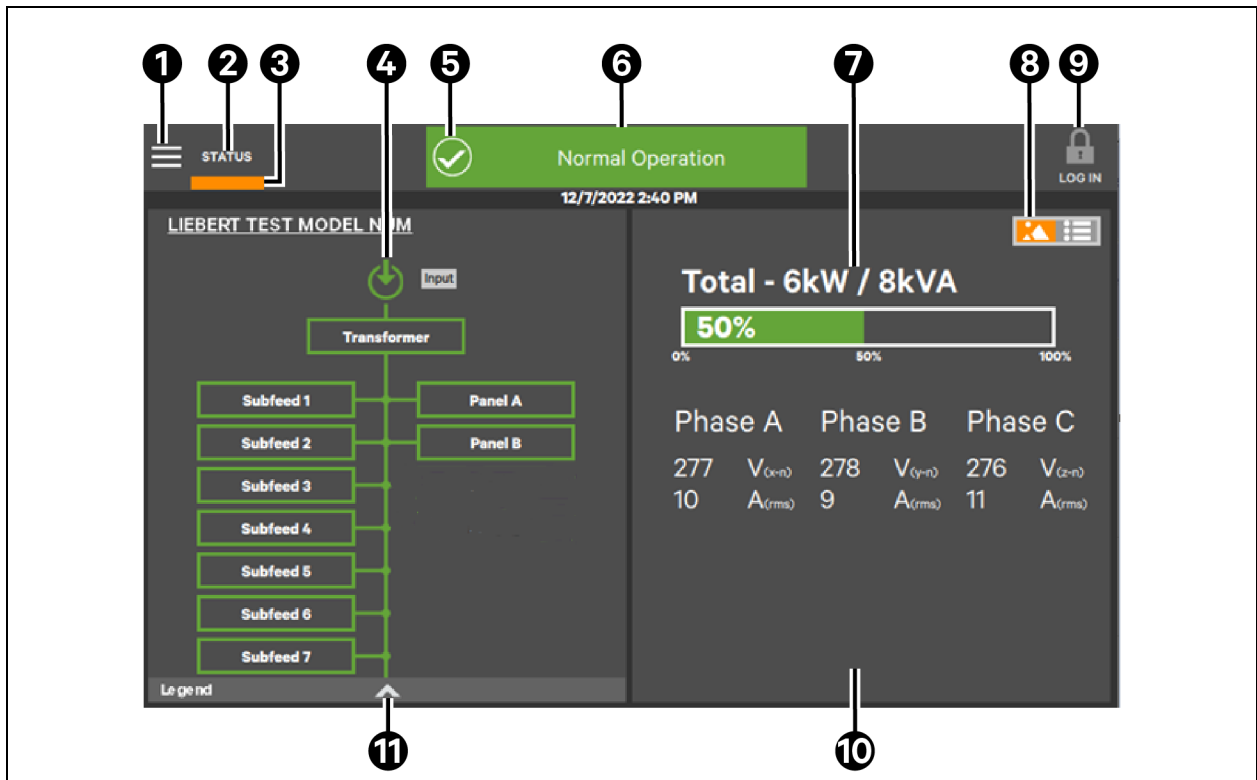
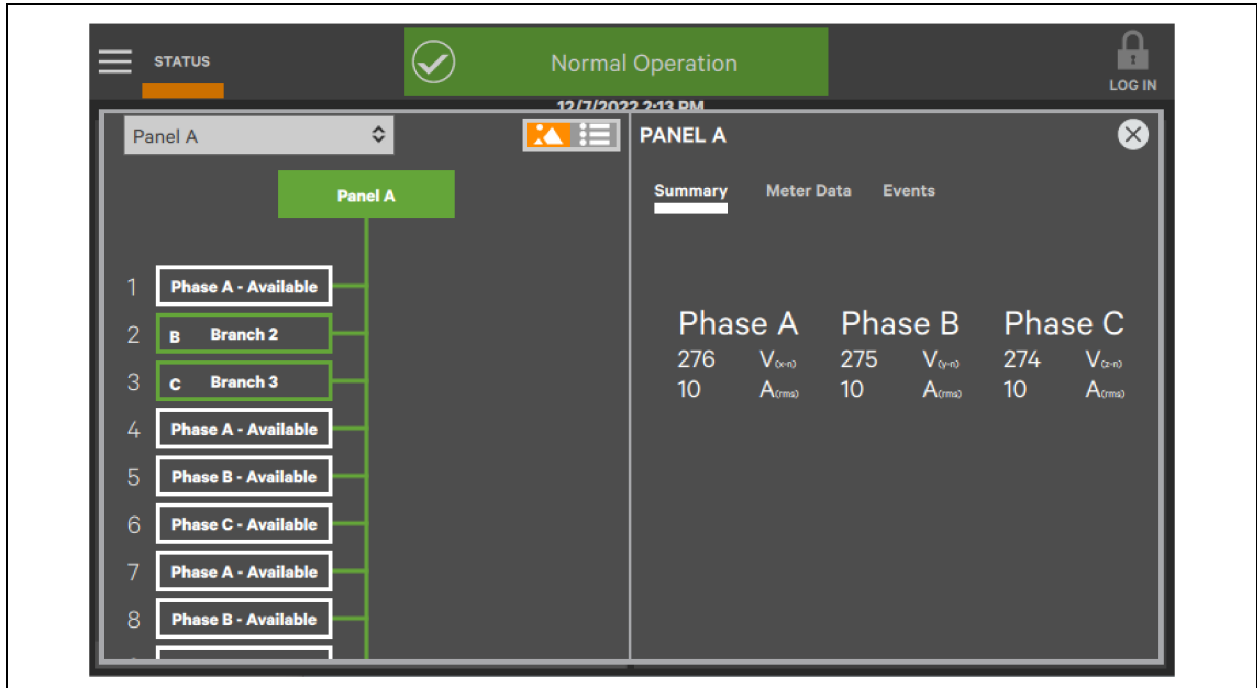
Checking the status of a particular component is as simple as touching it on the one-line display. Detailed data appears, allowing the operator to respond quickly to operational changes.

Visual and audible alarms alert personnel to faults and alarms requiring immediate attention. The legend drawer at the bottom left of the main display in the Default View defines the color codes for unit status (See **Figure 5.30** on page 63 , Graphical and Text Views).

PINs (Personal Identification Numbers) for each access level-Operator, Administrator and Service-secure the HMI against unauthorized changes. Observers (personnel without a PIN) can view PDU or RPP status through the HMI, but cannot change any configuration settings.



Figure 5.27 Controls and Indicators



Item	Description
1	Context menu icon
2	Navigation tab
3	Active navigation tab indicator
4	One-line system drawing; color-coded to indicate the status of each component
5	System status icon; changes to indicate overall status: Normal (Green Circle), Warning (Amber Triangle) or Alarm (Red Octagon)
6	Toolbar, color-coded for system status; touching the status header will take you to the Events screen where any active events may be viewed and managed; green indicates normal operation; amber denotes a warning and red denotes a critical fault; Toolbar will scroll through active warnings and faults
7	Upper meter showing output power usage for transformer
8	Graphical/text display switch
9	Login/logout icon
10	Lower meter showing output power usage for each phase
11	Legend drawer icon

Figure 5.28 System Status Toolbar: Warning and Alarm Examples



Figure 5.29 HMI Main Display, Text View, Operator Level

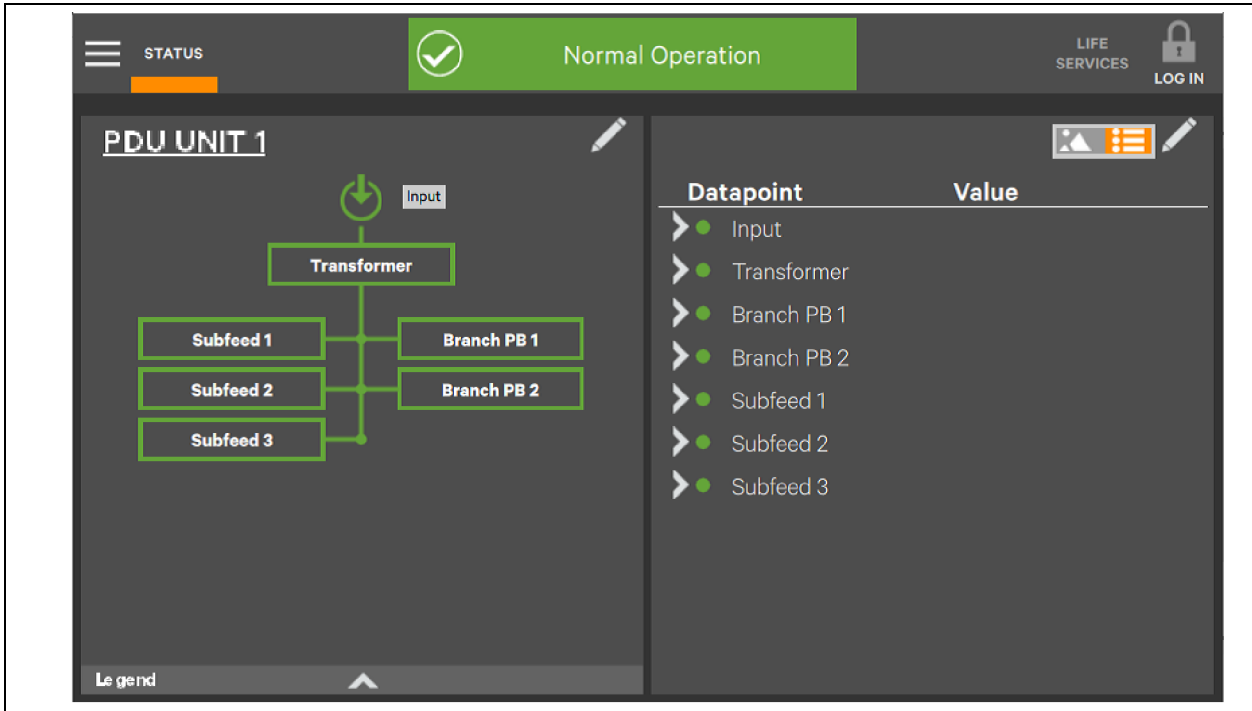
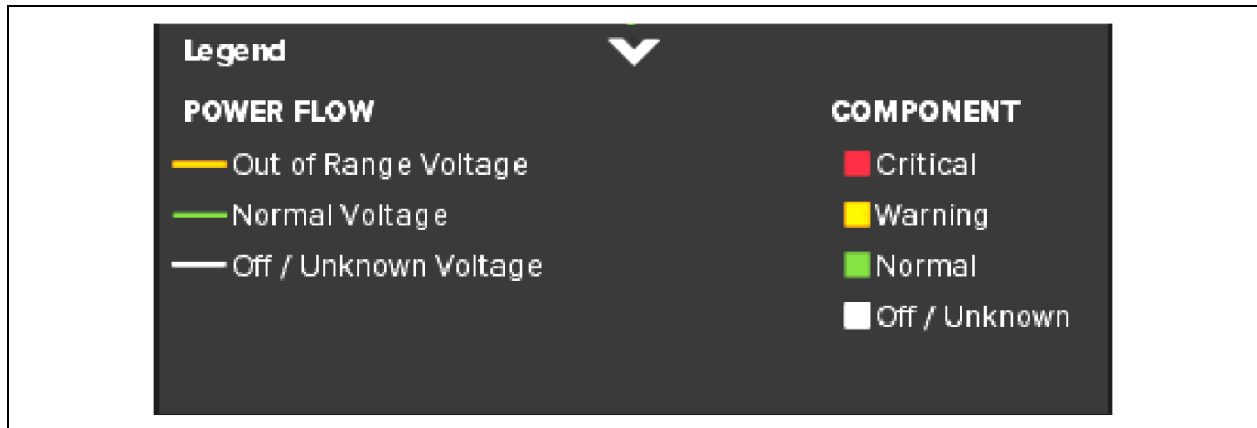


Figure 5.30 Legend



## 5.8.2 Restrict Physical Access with Barriers or Set Login Codes

The default time for a login to remain active without screen interaction is 5 minutes. This is set when the unit is configured. It can be altered at the Service level login.

The display has four access levels-Observer, Operator, Administrator and Service-each with different levels of authority. The Observer level, which does not permit configuration changes, does not require a PIN.

The default access level for the display is Observer. When a PIN is not required for the Administrator or Operator, the control panel opens at the Administrator level.

### Default PINs

**Observer:** None at default level

**Operator:** 1234 (default)

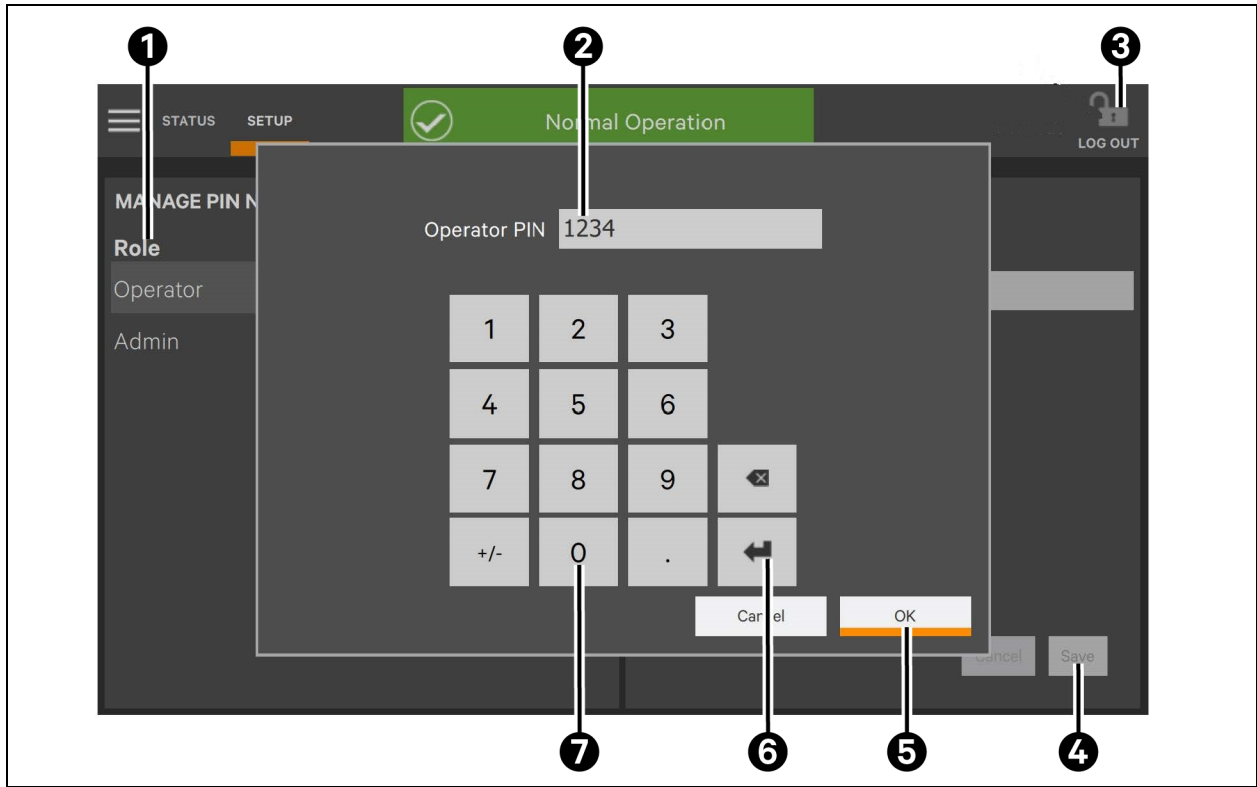
**Administrator:** 2345 (default)

### To set or change a PIN:

1. Log in to the HMI at the Administrator level (neither Observers nor Operators can change PINs).
2. Touch SETUP. The MANAGE PIN NUMBERS menu opens; either the Operator or Administrator PIN may be changed.
3. Touch the PIN to be changed and a keypad opens.
4. Enter the new PIN or delete the numerals to delete PIN requirements.
5. Touch the OK button.
6. Touch the Save button to keep your changes or touch the Cancel button to exit without saving.

**NOTE:** To delete PIN requirements, such as for a PDU or RPP in a secure area with restricted access, remove the PIN for the Operator level first, then delete the Administrator PIN. The Operator PIN must be empty before the Administrator PIN can be deleted. If an attempt is made to delete the Administrator's PIN first, the Touchscreen Control Panel will display a notice that the Operator's PIN is not empty. Conversely, the Administrator's PIN must be completed first if conditions change and PINs become required.

Figure 5.31 Restrict Physical Access with Barriers or Set Login Codes



Item	Description
1	Login level to be changed
2	PIN of level selected
3	Logout icon
4	Save button; must be pressed to make complete changes
5	OK button, must be pressed to proceed with changes
6	Enter key
7	Keypad

At login for all access levels, the Touchscreen Control Panel opens to the STATUS screen in graphic display. The STATUS view at each login level will show the one-line diagram and system status readings unless the default view has been changed. The appearance will differ only in the Context Menus displayed. The Observer and Operator menus are the same, but the Observer has view-only access.

Context Menus are available by touching STATUS or an access level (SETUP for Administrator or SERVICE for Service) and then touching the Context Menu icon at the top left of the Touchscreen Control Panel. A label at the top of the Context Menu signifies which level is being accessed. Touching a Context Menu item reveals data about a component or opens a submenu with additional options (See [Context Menu Controls](#) on page 70 ).

### 5.8.3 Choose a Theme

The Touchscreen Control Panel's default mode is a dark gray background with white headings and light gray text, dialog boxes with dark gray text and orange indicators. This is the view shown in this document. This will be acceptable for most applications, but it can be changed to a blue background or a light gray background, accompanied by changes to the dialog boxes and text. Users at any access level, Observer, Operator, Administrator and Service, can choose a theme. The selected theme will apply to the display at all access levels.

#### To choose a theme:

- Touch the Context Menu and select Display Options, then Display Properties.
- Touch the Theme dialog box and select a theme (See **Figure 5.32** below).
- Touch the Save button. (The Save button becomes active only after a new theme has been chosen).

Figure 5.32 Choose a Theme

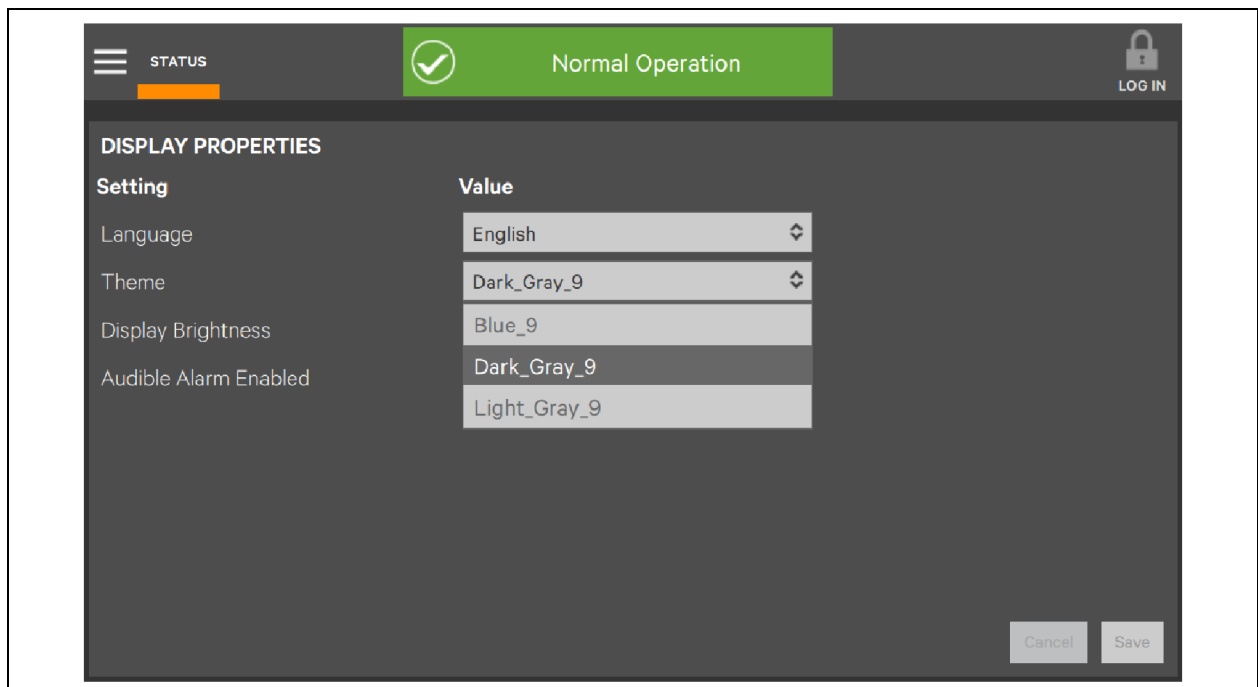
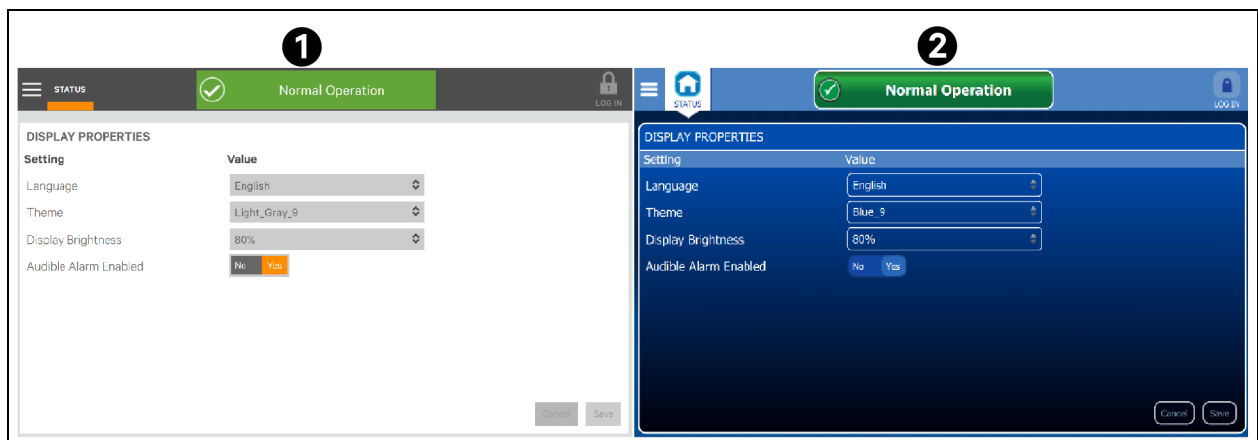


Figure 5.33 Themes: Light\_Gray\_9 and Blue\_9



Item	Description
1	Light_Gray_9 theme
2	Blue_9 theme

## 5.8.4 Setting Display Properties

The Context Menu for either OPERATE or SETUP permits determining how data is displayed and alarms are handled. The DISPLAY PROPERTIES menu is available to any user, including Observers. However, the items that may be altered differs with each access level, if PINs are required.

**Language:** The default setting is English.

**Theme:** The default setting is Dark\_Gray\_9; other choices are Blue\_9 and Light\_Gray\_9. Themes change not only the background, but also the color of some menus.

**Backlight Off Timer:** The default setting is Off After 5 Minutes; other choices are Off After 10 minutes, 20 minutes, 30 minutes, 45 minutes and, 60 minutes.

**Alarm Window Timeout:** If the backlight is Off and a fault occurs, the screen saver will be displayed until this timer expires. The default setting is Never. It may be changed in one-day increments from one day to 14 days.

**Auto-Logout Timer:** The default setting is Logout After 5 Minutes of no screen interaction. Choices are 1 minute, 2 minutes, 3 minutes, 4 minutes, 5 minutes, 10 minutes and, 15 minutes.

**Display Brightness:** The default setting is 80 percent, but the brightness may be changed in increments of 20 percent from 20 percent to 100 percent.

**Status Indicator Brightness:** The default setting is 80 percent; brightness may be changed in increments of 20 percent from 20 percent to 100 percent.

**Audible Alarm Enabled:** The default setting is Yes, but the alarm can be disabled.

**Calibrate Touch Screen:** No default value; instructions must be followed to calibrate the touchscreen. A notification warns that performing a calibration on a properly functioning touchscreen could cause the touchscreen to fail. The notification offers a choice of going ahead with the calibration or canceling it. Available Display Properties by Access Level if PINs are Required.

**Table 5.7 Setting Display Properties Checkpoints**

Display Property	Access Level Observer	Operator	Administrator	Service
Language	✓	✓	✓	✓
Theme	✓	✓	✓	✓
Backlight off timer	X	✓	✓	✓
Alarm window timeout	X	✓	✓	✓
Auto-logout timer	X	X	✓	✓
Display brightness	✓	✓	✓	✓
Status indicator brightness	X	✓	✓	✓
Audible alarm enabled	✓	✓	✓	✓
Calibrate touch screen	X	X	✓	✓

## 5.8.5 Change the Time Zone

The time zone is set when the Touchscreen Control Panel is configured (the default is America/New York). The drop-down menu permits selecting any time zone on the globe.

### To change the time zone:

1. Log in with Administrator access if PINs are required.
2. Navigate to STATUS>Display Options>Date & Time or to SETUP>Display Options>Date & Time.
3. Touch the Time Zone box or either arrow on the drop-down menu.
4. Scroll to the appropriate time zone and touch it.
5. Make any other changes on the DATE & TIME page.
6. Touch the Save button to make the changes or touch Cancel to exit without saving the changes.

## 5.8.6 Changing Date, Time and Measurement Formats

The Touchscreen Control Panel has these default settings:

**Date:** M/d/yyyy

**Time:** h/mm (either AM/PM or am/pm)

**Measurement System:** Metric

These formats may be changed by any user, including an Observer, by going to Status>Display Options>Formats; choose the format or measurement system and touch the Save button.

### Change the Date Format

To change the way the date is displayed, touch inside the box containing the date format and choose the format from the choices shown in Date/Time Format and Measurement System Choices.

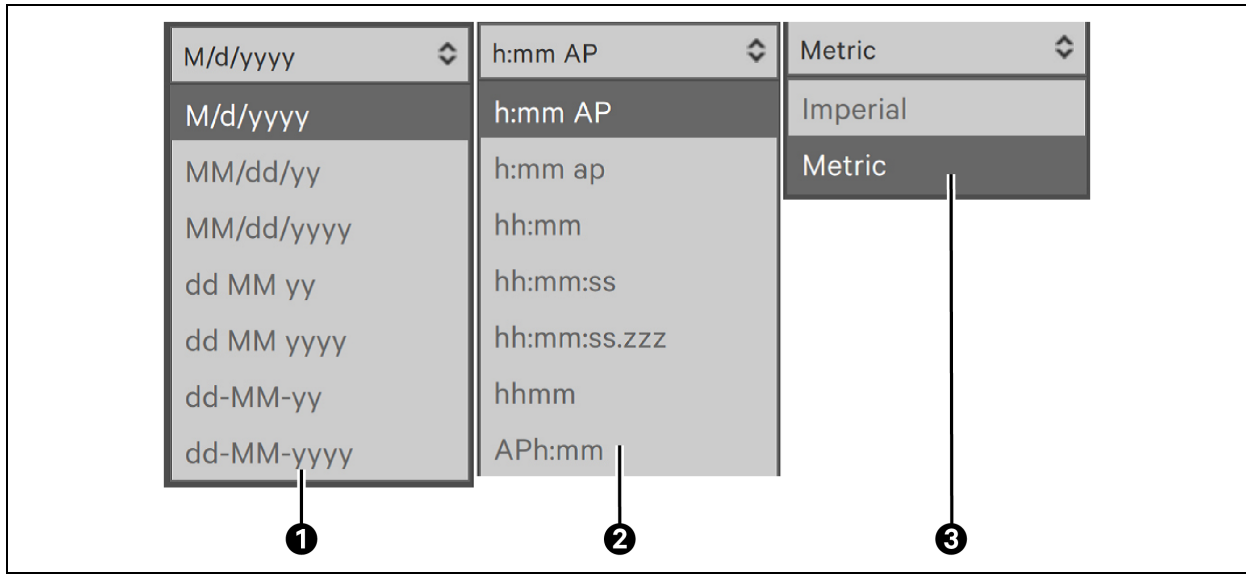
### Change the Time Format

To change the way the time is displayed, touch inside the box containing the time format and choose the format from the choices shown in Date/Time Format and Measurement System Choices.

## 5.8.7 Change the Measurement System

To change the way measured values, such as heat, are displayed, touch inside the box containing the Measurement System and choose either Imperial or Metric as shown in **Figure 5.34** on the next page .

Figure 5.34 Date/Time Format and Measurement System Choices



Item	Description
1	Date format choices; scrolling reveals more choices-change how the date is displayed.
2	Time format choices-change how the time is displayed.
3	Measurement format-change how measured values, such as heat, are displayed.

### 5.8.8 Log In to the Touchscreen Control Panel

The HMI is On whenever the PDU or RPP has control power. It may be dark and appear inactive, depending on its settings. If the panel is inactive, touch the LCD to activate it.

The Touchscreen Control Panel’s controls are available to anyone who has physical access to the PDU or RPP the panel is mounted on. However, control panel access may be restricted by ensuring PINs are set for Operator and Administrator access. The Operator, Administrator and Service levels require a PIN by default; these PINs may be changed from the factory-set numbers.

**NOTE:** Vertiv recommends recording any PINs set and storing the numbers where they are accessible if they are forgotten. A user with authority to change a PIN will be able to see PINs of those with equal or lesser access.

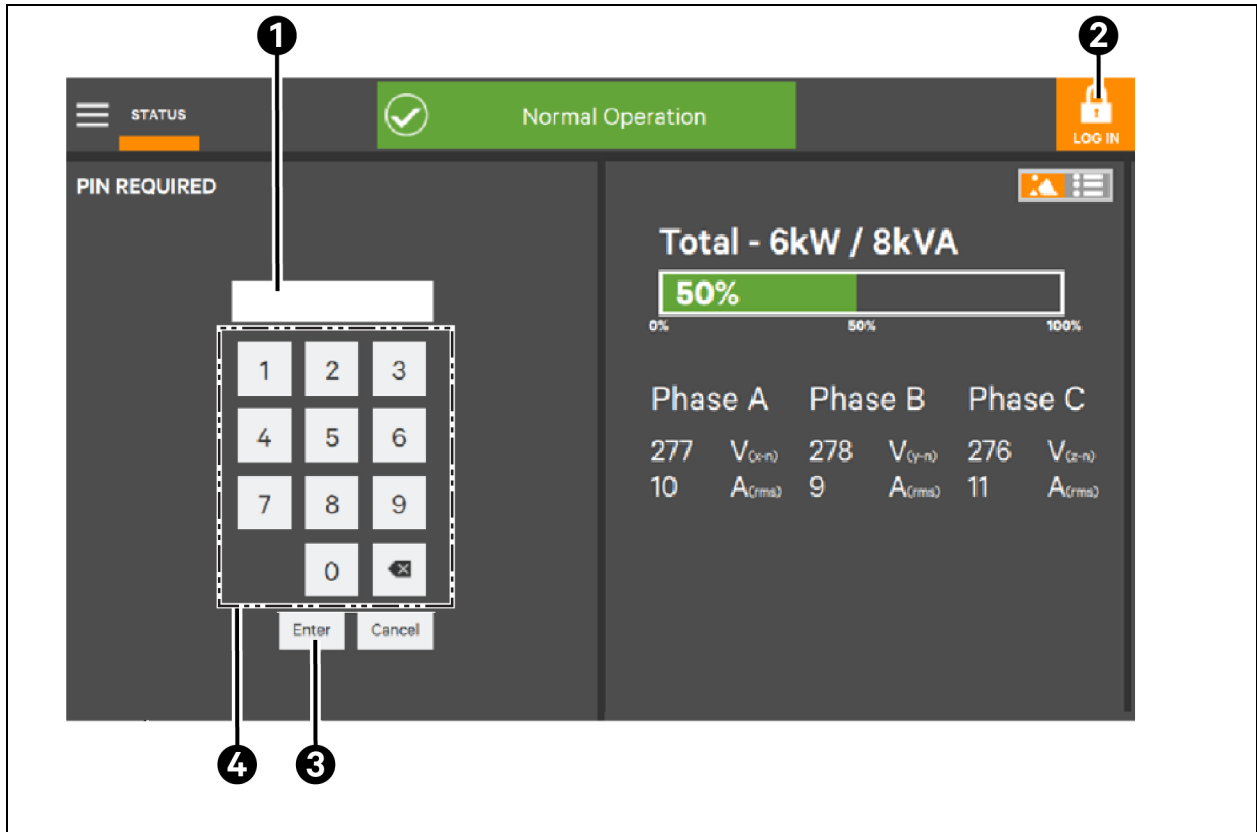
**NOTE:** After a user finishes logging in, the system will return navigation to the location displayed when you pressed the login button.

**To log in to the Touchscreen Control Panel:**

1. Touch the LOG OUT icon at the top right of the screen. The lock will close and be renamed LOG IN.
2. Touch the LOG IN icon. The background will change color and open a screen with a keypad.
3. Enter a PIN at the screen below.
4. Touch **Enter**.

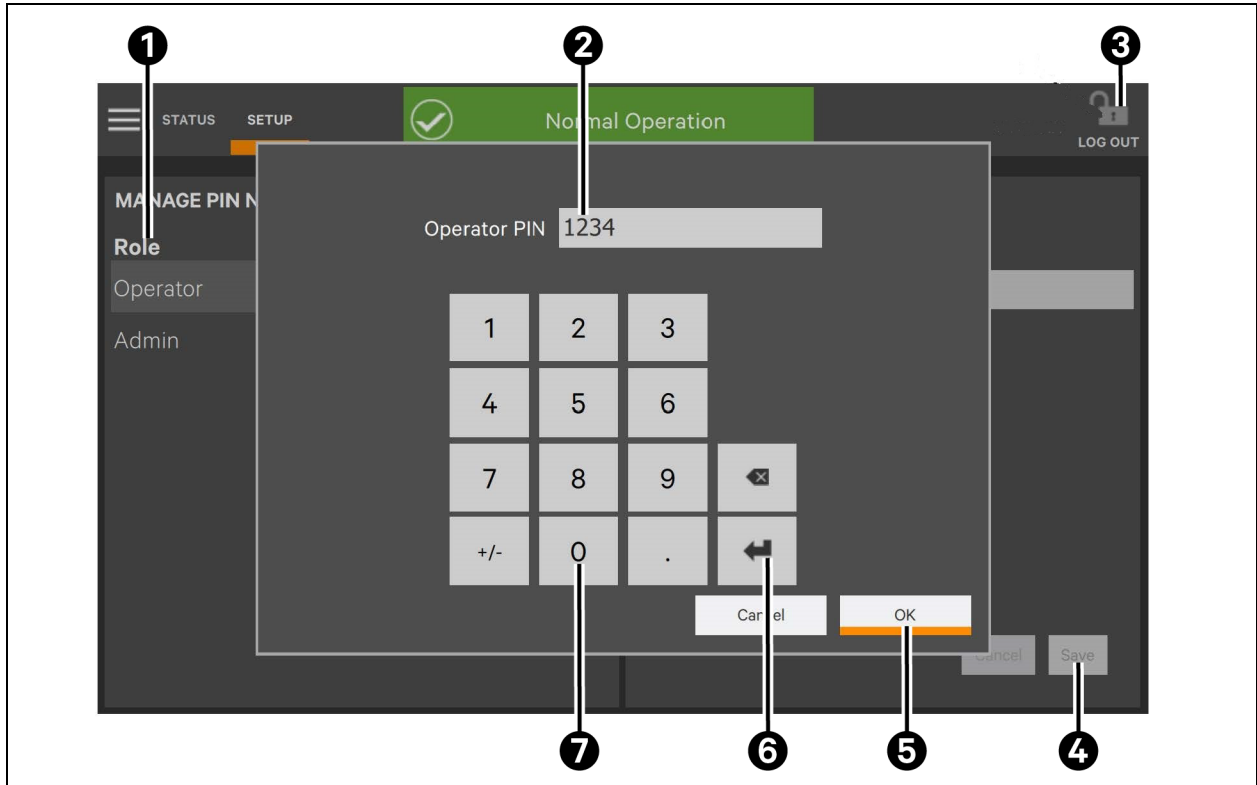


Figure 5.35 Log In to the Touchscreen Control Panel



Item	Description
1	PIN shown when entered
2	LOG IN icon
3	Enter button
4	Keypad

Figure 5.36 Set a PIN



Item	Description
1	Role whose PIN will be changed (Operator or Administrator)
2	Current PIN, shown after touching PIN Value
3	Log out icon
4	Save button
5	OK button
6	Enter button
7	Keypad

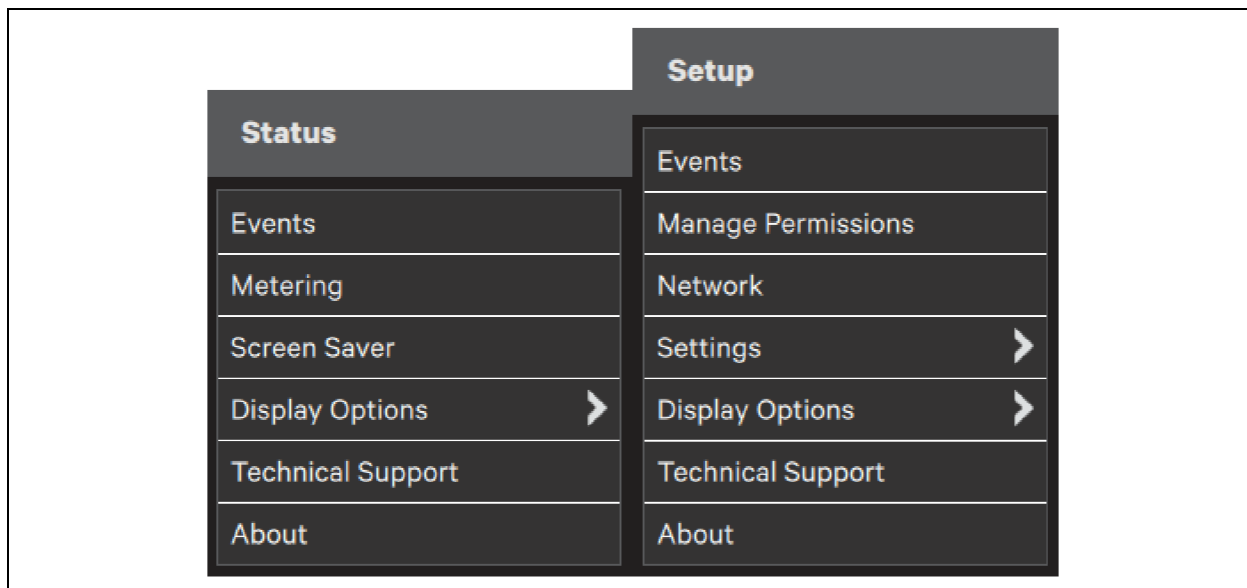
**NOTE:** Vertiv recommends keeping a current list of PINs in a location known to administrative personnel and updating the list immediately when a PIN is changed.

### 5.8.9 Context Menu Controls

Context Menus at the top left side of the Touchscreen Control Panel contain links that aid in configuring and managing the PDU or RPP. The choices vary by access level, as do the actions permissible.

The Context menu seen by an Observer appears identical to the Context Menu seen by an Operator. However, when an Operator or Administrator is logged in, the Context Menu permits actions, such as customizing the layout, that are not permitted at the Observer access level.

Figure 5.37 Context Menu: Observer/Operator; Administrator



### 5.8.10 Context Menu Commands for Administrators

The Administrator's Context Menu is available by logging in as Administrator, touching SETUP and then touching the Context Menu icon. An Administrator is able to change most configurable items in the Context Menu.

The Context Menu will show:

- **Events:** Date and time of each configured event's occurrence, type of event, component affected and description. Events can be sorted by time of occurrence, component, subcomponent (system, breaker, panelboard) and description. If a component or subcomponent name is too long, the HMI displays an ellipsis. Clicking on that row will create a double row displaying the full component or subcomponent name. For more information, refer to [Reset and Silence Faults and Events](#) on page 78.
- **Manage Permissions:** Change or require PIN for users of Administrators or Operators. For information, refer to [Touchscreen Display and User Interface](#) on page 1.
- **Network:** Modify communication settings. See [View or Change Network Settings](#) on the next page for more information.
- **Settings**
  - a. **Export:** Allows user to export the current display properties settings to a file and store it on an inserted USB drive.
- **Display Options:** (See [Setting Display Properties](#) on page 66)
  - a. **Display Properties:** Language, Theme, Backlight Off Timer, Alarm Window Timeout, Display Brightness, Status Indicator Brightness, Audible Alarm Enabled and Calibrate Touch Screen.
  - b. **Date and Time:** Set Time Zone Country and Region, Date, Local Time and UTC Time.
  - c. **Formats:** Date Format, Time Format and Measurement System, either Imperial or Metric.
- **Technical Support:** Manufacturer's support: Web site, e-mail address and telephone numbers.
- **About:** Information about the Vertiv LDMF HMI and its firmware.

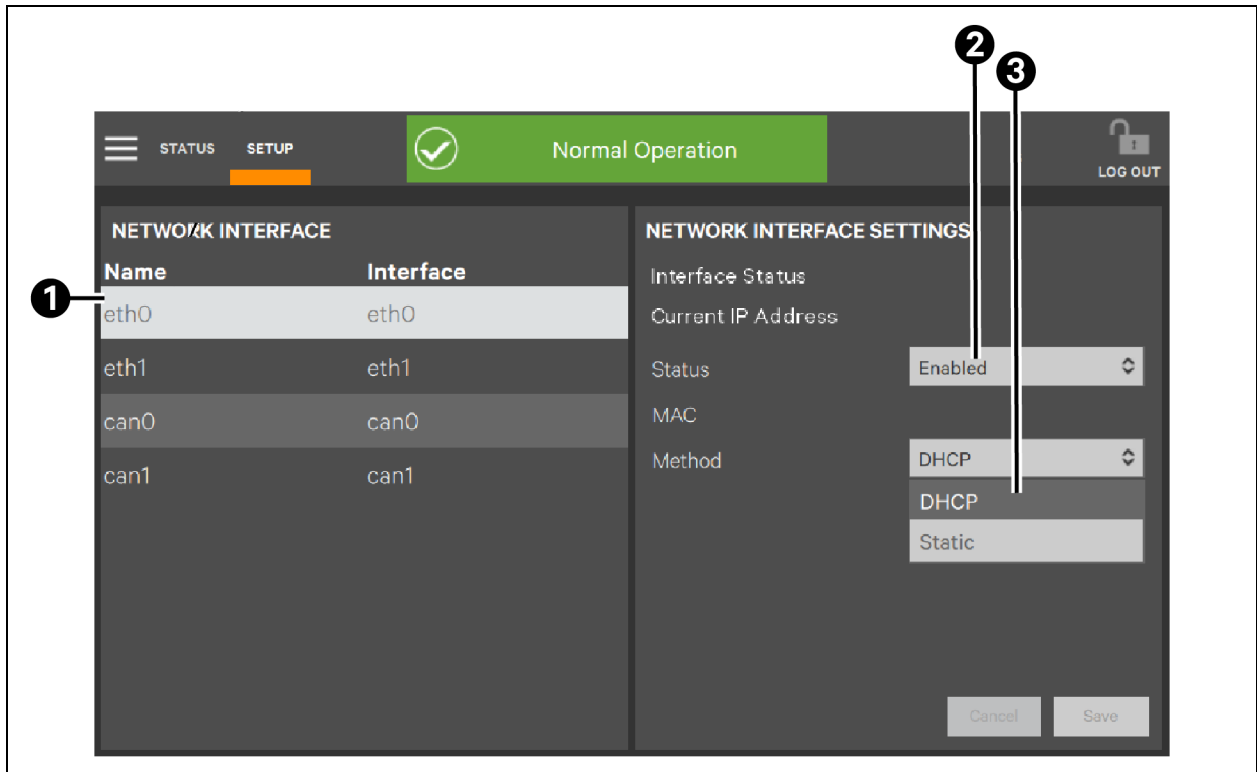
### 5.8.11 View or Change Network Settings

Because the LDMF HMI monitors and manages the PDU or RPP over a network, the HMI restricts communication setting changes to those with Administrator and Service access, if PINs are required. These settings were originally made at the factory or set up by Vertiv Services during the system's initial configuration.

**To view or change Network settings:**

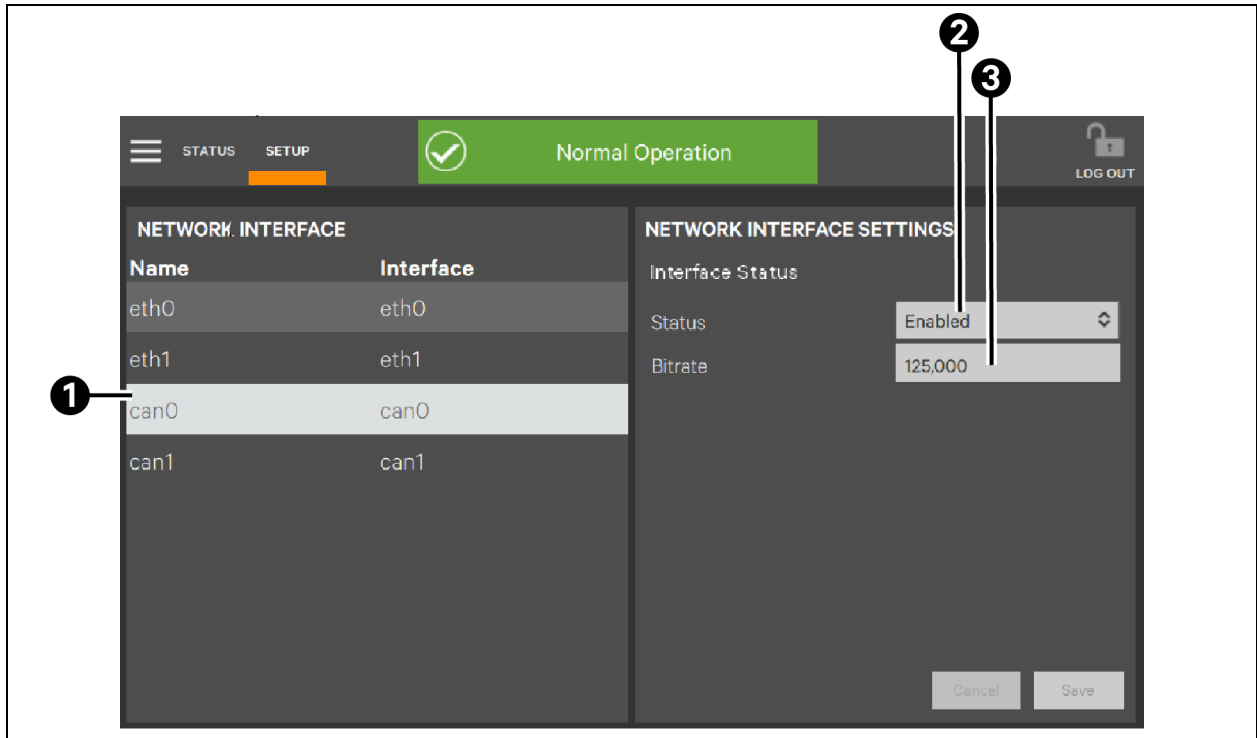
1. Log in with Administrator or Service access.
2. Touch SETUP, touch the Context Menu icon and Network.
3. Select a network interface to change by touching the name on the left side of the Touchscreen Control Panel. Ethernet connections can be enabled or disabled and the IP address source can be set to DHCP or Static. CANbus connections can be enabled or disabled and the bit rate can be changed by touching the dialog box associated with Bitrate. Touching the dialog box opens a keypad where the bit rate can be entered.

**Figure 5.38 View or Change Network Settings**



Item	Description
1	Ethernet network selected
2	Enabled/disabled choice
3	IP address source: DHCP or static

Figure 5.39 Change Network Settings: CANbus



Item	Description
1	CANbus network selected
2	Enabled/Disabled choice
3	Bit rate settings box; touching box opens keypad

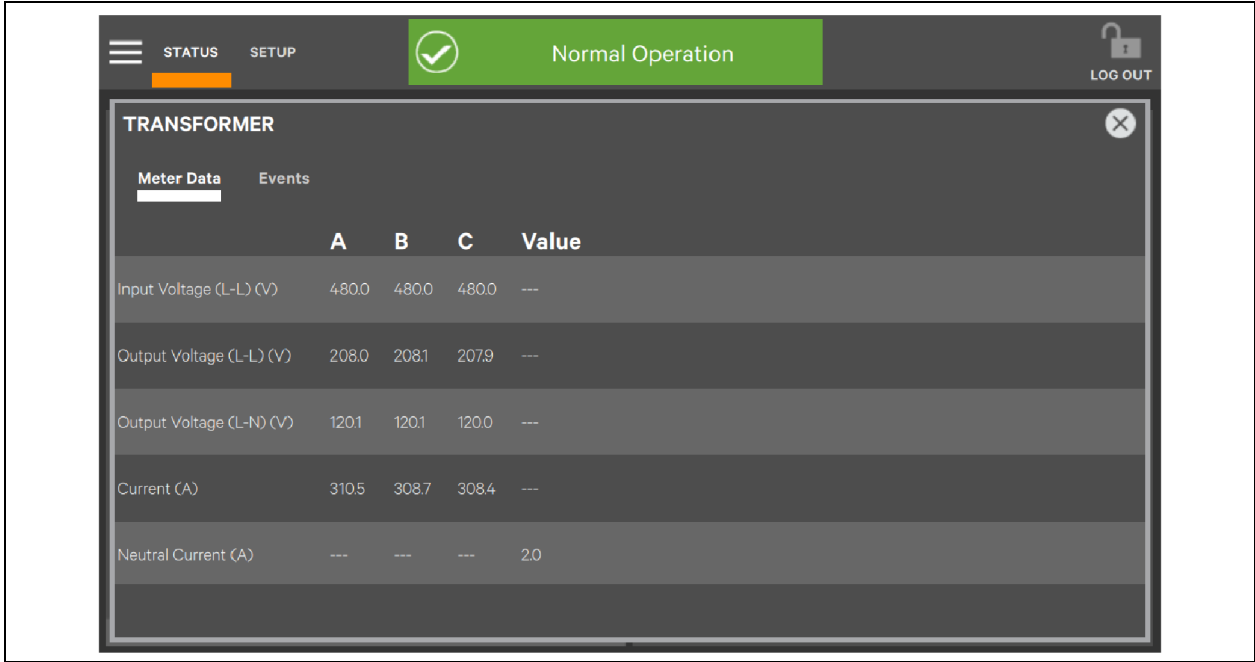
## 5.8.12 View System Status

### View Overall System Status

To view the overall system's condition, touch the STATUS heading on the HMI. The Touchscreen Control Panel displays the default view, factory-set to show the one-line diagram and system summary status. If the system is operating normally, with no faults and no warnings, the toolbar at the top center of the screen will be green and will display a check mark (See **Figure 5.40** on the next page ). The one-line diagram will also be green. Warnings and faults will color the toolbar amber or red; the affected parts of the system will also be amber or red in the one-line diagram.

For detailed information touch Transformer at the top of the one-line diagram. The HMI opens to the TRANSFORMER screen at Meter Data. This displays metered values for each phase (See **Figure 5.40** on the next page ).

Figure 5.40 SYSTEM Meter Data



Parameters	
Ground current (A)	Energy (kWh)
Current load % (A)	Current crest factor
Frequency (Hz)	K-Factor
Real power (kW)	iTHD (%)
Apparent power (kVA)	vTHD (%)
Power factor (Abs)	

The HMI will also display Meter Data for each panelboard and for subfeeds.

### 5.8.13 View Component Status with One-Line Diagram Links

The default display in the HMI permits fast and easy monitoring of system components through labeled links. These links span the full system, from input down to each individual breaker. Touching a component's link displays information about that component.

#### Panelboard Status

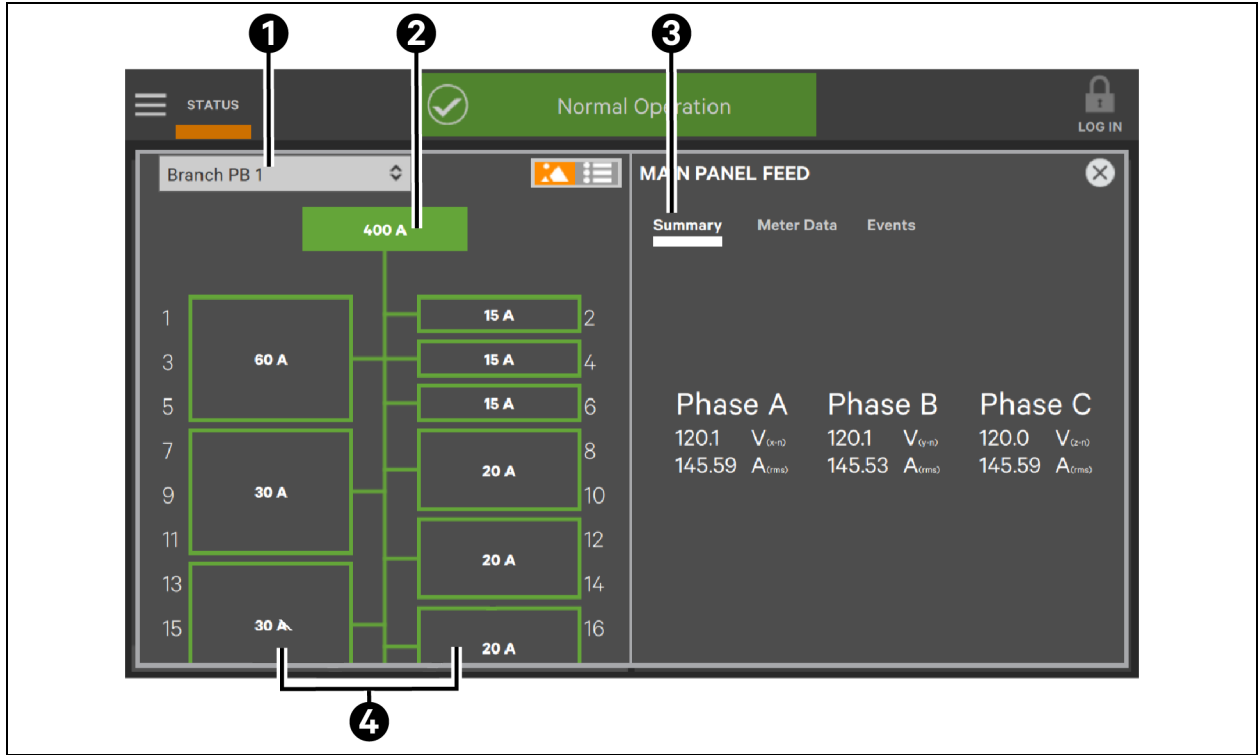
The Summary tab displays the phase loading graphically or numerically (text) for the entire panelboard. The thresholds for the warning/fault color are the overcurrent warning/fault thresholds for the panelboard.

#### To view a Panelboard's Summary Status:

1. Touch Status > Panelboard. This displays a one-line diagram of the panelboard's components, each color-coded to show its status and opens to the Summary tab.
2. For information about any component, touch its icon on the Touchscreen Control Panel.

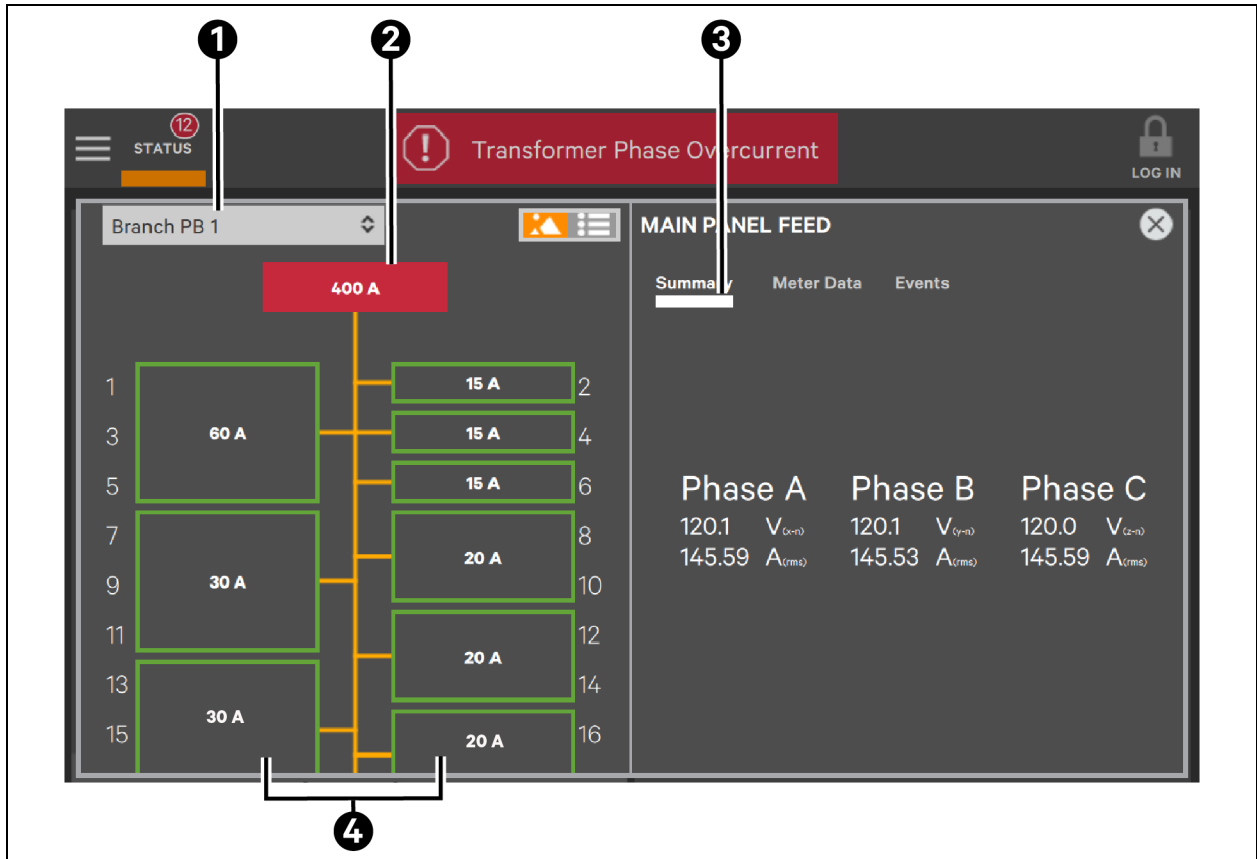
The additional information is helpful when troubleshooting a fault or alarm, as shown in **Figure 5.42** on the next page .

**Figure 5.41 Panelboard Summary Status: Normal Operation**



Item	Description
1	Panelboard being viewed
2	Panelboard main
3	Summary tab
4	Panelboard branch breakers

Figure 5.42 Panelboard Summary Status: Fault



Item	Description
1	Panelboard being viewed
2	Panelboard main
3	Summary tab
4	Panelboard branch breakers

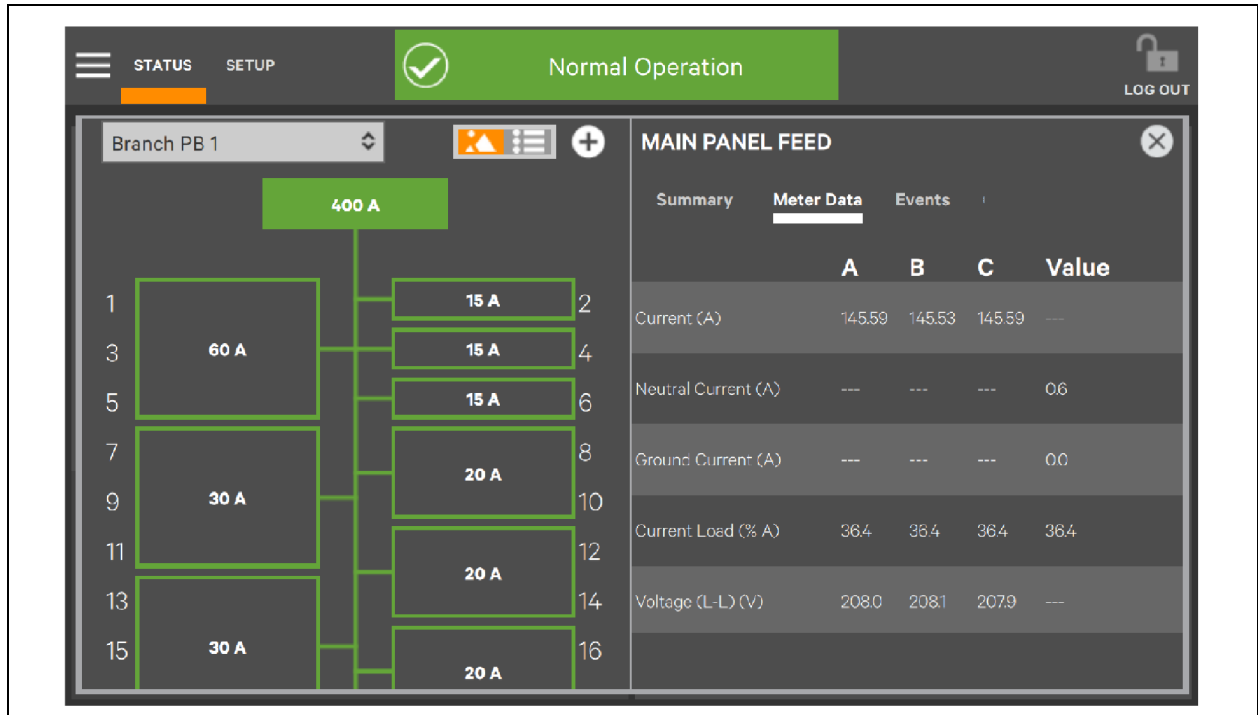
**To view a panelboard's metering data:**

Touch Status, then touch the panelboard in the one-line diagram. This displays a one-line diagram of the panelboard's components, each color-coded to show its status.

Touch Meter Data. This displays the view shown in **Figure 5.43** on the next page .



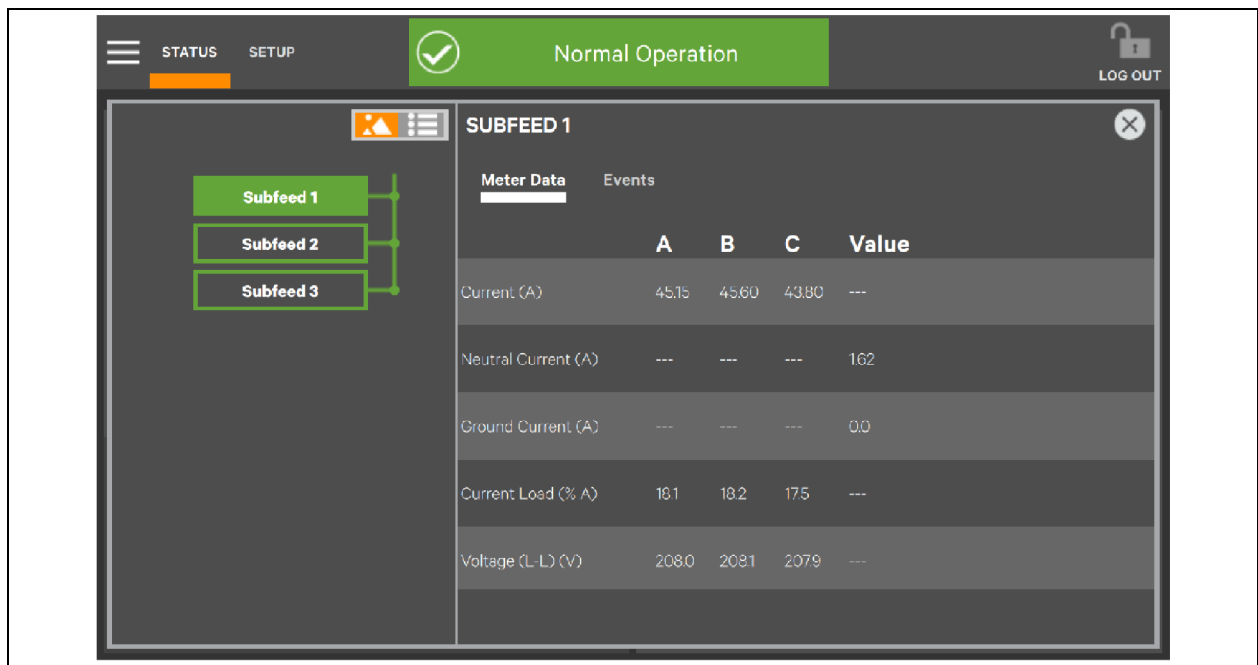
Figure 5.43 View Panelboard Meter Data



To view a subfeed's metering data:

Touch Status, then touch the subfeed in the one-line diagram. This displays a one-line diagram of the subfeed (depending on touchscreen space) and the Meter Data screen for the subfeed as shown in Figure 5.44 below.

Figure 5.44 View Subfeed Meter Data



## 5.8.14 Reset and Silence Faults and Events

### Active EVENTS List: Overview

The HMI permits easy management of faults, warnings and events through the active Events list. The list is accessible by touching the Toolbar in the top middle portion of the Touchscreen Control Panel. The active EVENTS list enables personnel to pinpoint the location of a system fault or warning and remedy the problem quickly and prevent damage to connected equipment.

Personnel with Operator, Administrator or Service access can use the active EVENTS list to view, silence, and reset faults and warnings. Observers can view and silence warnings and faults but cannot reset them; the Reset Fault button is not visible at the Observer access level.

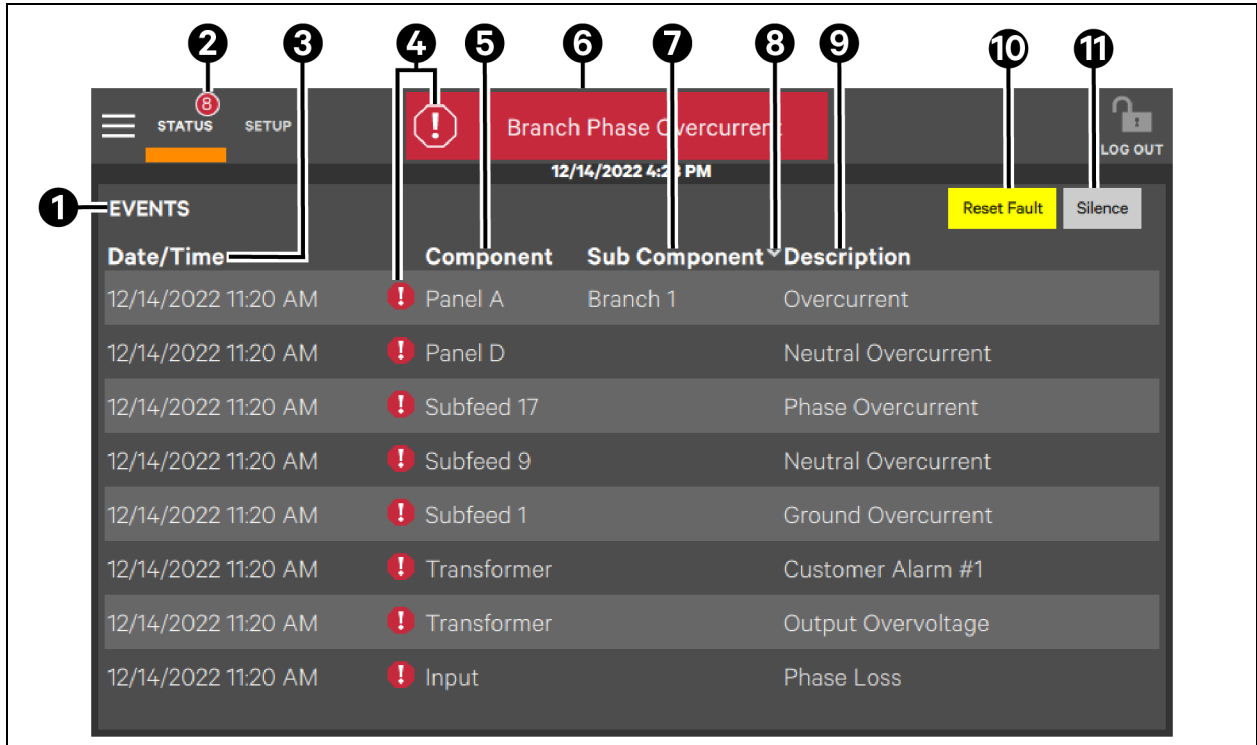
Critical faults and warning events are registered immediately on the HMI. If the Touchscreen Control Panel is in screen saver mode when a warning or fault occurs, it will automatically open to the default view and display the event. The Toolbar changes to either amber (warning) or red (critical fault), depending on the severity of the event. An audible alarm may also sound if the PDU or RPP is equipped with one and the audible alarm is enabled.

### Manage an Active Event

#### To manage a fault or Alarm:

1. Log in with Operator, Administrator or Service access if PINs are required.
2. Touch the Toolbar. This opens the active EVENTS list.
3. Touch a fault or event to select it.
  - a. The fault can be silenced if it is still active by touching the Silence button.
  - b. If the fault's cause has been resolved, the fault can be reset by touching the Reset Fault button. The Reset Fault button will be grayed-out if the cause of the fault or alarm remains unresolved.

Figure 5.45 Manage an Active Event



Item	Description
1	Active EVENTS list, displayed by touching the toolbar in the top middle portion of the touchscreen control panel.
2	Tally of active events.
3	Date/Time of event occurrence.
4	Event severity icon. A red shield with an exclamation point denotes a critical fault; a yellow shield with an exclamation point denotes a warning; a green shield with a check mark is normal operation.
5	Component that the event affected.
6	One of the active events on the Toolbar; all active events will scroll across the toolbar when more than one event is active; touching the bar displays the active EVENTS list.
7	Sub component (if applicable) where event occurred.
8	Arrowhead denotes which heading was used to sort the active EVENTS list (sub component in this instance).
9	Description of events.
10	Reset fault button.
11	Silence event button.

This page intentionally left blank

## 6 Specifications

Electrical	
Voltage	120 - 240 VAC (-13% to +6%)
Frequency	50 and 60 Hz
Current transformers rating (secondary winding)	1 A for branch circuits and subfeeds 1 A for panelboard main breaker
BSM current	0.5 A to 120 A
CT accuracy	5% for 0.5-2 A 1% for 2 - 100 A 5% for 100-120 A
Minimum current	200 mA
Environmental	
Humidity	0-95%
Temperature (non-operating)	-68 °F to 158 °F (-20 °C to 70 °C)
Temperature (operating)	32 °F to 104 °F (0 °C to 40 °C)

This page intentionally left blank

## 7 Troubleshooting or Frequently Asked Questions

1. How do I obtain the software necessary to monitor and configure the Vertiv™ Liebert® LDMF?
  - The software package is available from the Liebert Web site, [www.Vertivco.com](http://www.Vertivco.com). Under Service and Support, choose Software Downloads.
  - Click on the link for the LDMF-mm/yyyy Toolkit:

where mm/yyyy is the month and year of the update—for example, 08/2016 or 11/2016

**NOTE: There are two versions of Liebert® Distribution Monitoring software.**

**Be sure to select the LDMF version, which is for units with a setup port labeled LDMF Setup.**

**Do NOT choose the Liebert® Distribution Monitoring (LDM) Tool Kit. (The LDM Tool Kit is used on units with a setup port labeled LDM Setup.)**

- Save the file to a desktop or laptop computer (PC) and extract the contents.

**NOTE: The software may be updated and changed without any notification. Check the Web site regularly to ensure the software is up-to-date.**

2. What is contained in the downloaded software package?
  - The flash program with a walk-through instruction.
  - The configuration program.
  - The monitor program.
3. What should I do if the BMS is reporting an overcurrent alarm?
  - Verify the circuit is not actually overloaded.
  - Using the Configuration program, verify that alarm setpoints and the CT ratio are correct.
  - If settings are correct, verify that the BMS is operating correctly.
  - If the issue still exists, contact Vertiv Support at 800-543-2378 for assistance.
4. I get an error message “Incorrect Schema Version” when I try to run the Monitor tool or Configuration tool. What should I do?
  - Ensure that only one program—either Monitor or Configuration—is running at a time. You can’t run both programs at the same time.
  - Contact Vertiv Support to ensure correct tool for the firmware.
  - Verify the PC is connected to the LDMF Setup port and the communication cable (F-F null modem DB9) is fully seated (See [LDMF Setup Port Connection](#) on page 25).
  - Verify the Liebert® LDMF unit has power (Green LEDs on the BCB will be flashing).
5. How can I make a backup copy of the configuration file?
  - Connect to the external LDMF Setup port (See [LDMF Setup Port Connection](#) on page 25).
  - Run the configuration program (See [Starting the Configuration Program](#) on page 31).
  - At the bottom of the Configuration window, select Save to File. Navigate to a location on your PC to store the file (See [Save the Configuration File to Disk](#) on page 36).

This page intentionally left blank



## 8 Glossary of Abbreviations

The following abbreviations are used in this manual.

**Table 8.1 Glossary**

Unit	Description
BCMS	Branch Circuit Monitoring System
BMS	Building Management System
BSM	Branch Sensor Module
DSP	Digital Signal Processor
GUI	Graphic User Interface
HMI	Human-Machine Interface
IGM	Information Gathering Module
LDMF	Liebert Distribution Monitor Front Access
LDMFS	Liebert Distribution Monitor Front (Square-D Panelboards)
LDMFG	Liebert Distribution Monitor Front (GE Panelboards)
LDMFI	Liebert Distribution Monitor Front (I-Line Panelboards)
LDMF4	Liebert Distribution Monitor Front (480 V Distribution Cabinets)
PAB	PM4 Adapter Board
PCD	Power Conditioning and Distribution
PDU	Power Distribution Unit
PM4	Power Monitoring 4th Generation
PIB	PM4 Interface Board
PLIB	PM4 Large Interface Board
PMB	PM4 Monitoring Board
STP	Service Terminal Port

This page intentionally left blank

### **Connect with Vertiv on Social Media**



<https://www.facebook.com/vertiv/>



<https://www.instagram.com/vertiv/>



<https://www.linkedin.com/company/vertiv/>



<https://www.twitter.com/Vertiv/>



---

Vertiv.com | Vertiv Headquarters, 1050 Dearborn Drive, Columbus, OH, 43085, USA

© 2023 Vertiv Group Corp. All rights reserved. Vertiv™ and the Vertiv logo are trademarks or registered trademarks of Vertiv Group Corp. All other names and logos referred to are trade names, trademarks or registered trademarks of their respective owners. While every precaution has been taken to ensure accuracy and completeness here, Vertiv Group Corp. assumes no responsibility, and disclaims all liability, for damages resulting from use of this information or for any errors or omissions. Specifications, rebates and other promotional offers are subject to change at Vertiv's sole discretion upon notice.

SL-20200\_REV9\_01-23