

Vertiv™ Edge

500-3000VA, 1, 230V In, 230V Out



Quick Installation Guide



Thank you for your recent purchase of a Vertiv Edge! We appreciate your business and are confident that your new product will provide many years of uninterruptible power to your connected equipment. With this purchase, you may also want to consider Vertiv's complete line-up of Racks, PDU's, Thermal Solutions, KVM Switches, and Serial Consoles. Vertiv also offers a broad array of Services and Extended Warranties. If you require any support, please don't hesitate to reach out to Vertiv or one of our Resellers or Local Rep Firms. We stand ready to support you. We sincerely hope that you'll continue to select Vertiv for all of your future infrastructure needs!

The Vertiv Team

Model Design Configurations

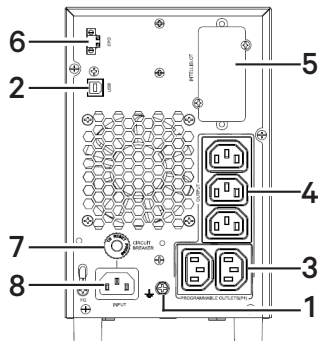

EDGE-750/1000IMT

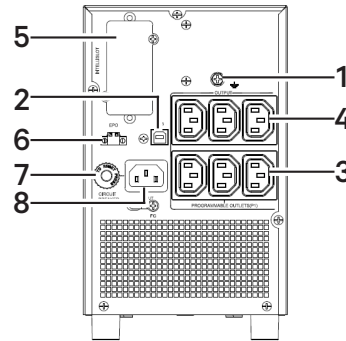

EDGE-1500IMT

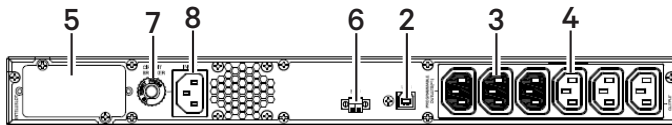

EDGE 1U 500-1500VA

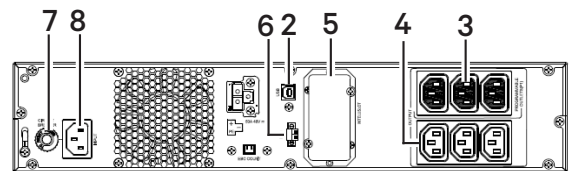

EDGE 2U 1500VA

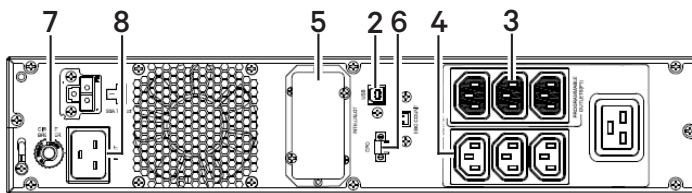

EDGE 2U 3000VA

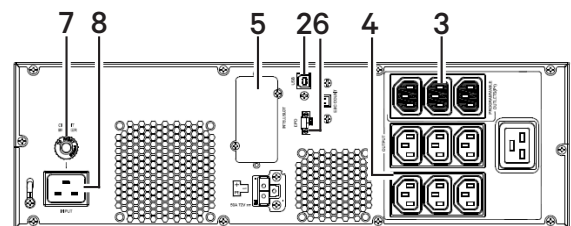

EDGE 3U 3000VA

IMPORTANT: Before installing, connecting to supply or operating your Vertiv™ Edge, please review the Safety and Regulatory Statements sheet. For detailed installation, operating, maintenance and troubleshooting information refer to the Edge User Guide available at www.Vertiv.com.

Item	Description	Item	Description
1	Grounding screw	5	Vertiv™ Liebert® IntelliSlot™ port
2	USB communication port	6	Emergency Power Off (EPO) connector
3	Programmable receptacles	7	Input circuit breaker
4	Non-programmable receptacles	8	AC input

Installation

1. Inspecting the UPS

Inspect the UPS for any signs of obvious damage. If damage is visible, do not proceed and call our warranty support line for assistance at 0080011554499 (Toll free), +39 02 98250222 (Toll), or email at eoc@vertiv.com.

2. Choosing a location

Install the Vertiv™ Edge in a temperature controlled environment that is free of corrosive and conductive contaminants. Avoid locations near heat or water sources and exposed to direct sunlight. For proper ventilation, leave four inches clearance on all sides of the UPS.

The input outlet should be nearby and easily accessible.

3. Installing the UPS

The Vertiv™ Edge and optional Vertiv™ Edge External Battery Cabinets may be installed in either a tower or rack configuration. For tower installation, assemble and attach the tower support stands. For rack installation, attach the brackets to the UPS, install the rail kit in the rack if needed, and install the UPS in the rack.

Connections

1. Connecting Loads

The UPS has non-programmable and programmable rear outlets. Plug your critical equipment (such as computer, monitors, etc.) into the non-programmable outlets and your less critical equipment (such as printers and other less often used peripherals) into the programmable outlets.

3. EPO Connection (Optional)

To comply with national and local wiring codes and regulations, the EPO connector internally disconnects all power sources to the UPS and connected equipment. To use this feature remove the factory installed jumper on the rear panel EPO connector and connect to active-open contacts that are normally closed but open during

2. USB Communication Connection (Optional)

Connect the Vertiv™ Edge through the rear panel USB Type-B port to a computer via USB to allow unattended, controlled shutdown of your computer in case of UPS input power failure. The UPS works with the computer running software built in within the Microsoft® Windows operating system or the Vertiv Power Assist Shutdown software located at www.Vertiv.com.

an emergency power off event. Operating logic may be reversed in the Settings menu. If you do not use the EPO connector, leave the factory installed jumper in place and the default (active-open) EPO setting in the Settings Menu.

4. External Battery Cabinet Connection (Optional)

External battery cabinets provide longer battery run time for connected devices. Refer to Edge User Guide, to select the appropriate model and quantity for your Vertiv™ Edge model and applications. Up to 6 battery cabinets can be connected to the Vertiv™ Edge.

1. Turn off the UPS utility input.
2. Open the front left cover on the UPS and the External Battery Cabinet (EBC) and disconnect the internal batteries.
3. Remove the EBC terminal covers from the UPS and the

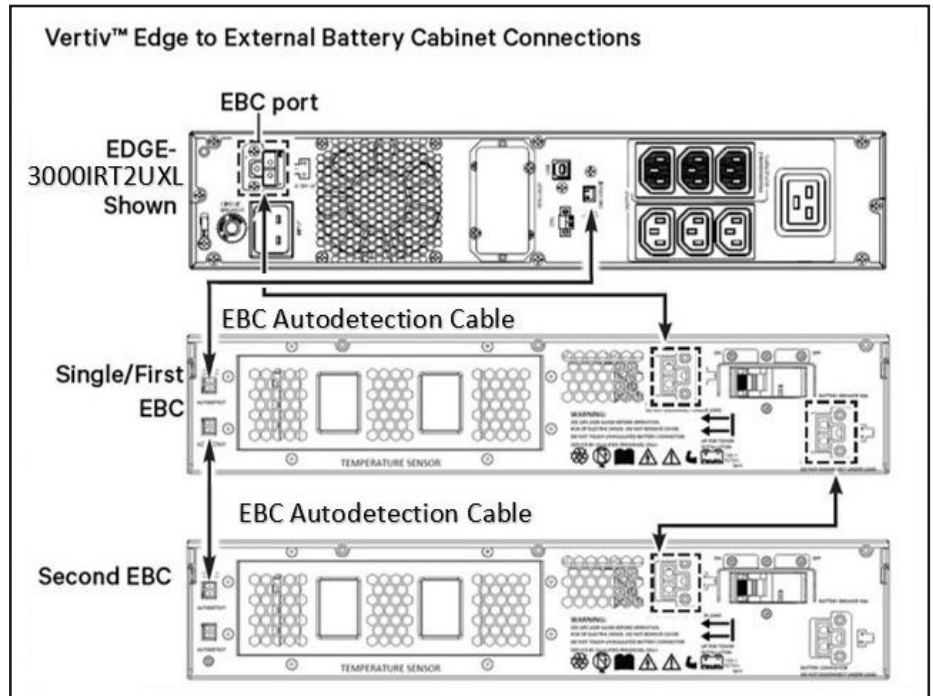

EBC. Connect one end of the external battery cable to the UPS and one end to the battery cabinet. If connecting more than one external battery, connect one end of the external battery cable to the second connector on the battery cabinet, then connect the other end to the next battery cabinet.

- Once the UPS and EBC(s) are connected, secure the connection with the screws, reconnect the internal batteries and replace the front left covers on the units.
- After installation and initial startup, set the number of installed battery cabinets in the UPS settings.

6. Network Communication Card Connection (optional)

For external status monitoring, there is a network communications port where the Vertiv™Liebert® IntelliSlot™ Unity Communications card can be installed.

- Remove the two screws and protective cover on the rear panel network communications port.
- Insert the card into the port and secure it with the screws. Refer to the documentation with the card or at www.Vertiv.com for cable connection and operation.

7. Connecting AC Input

Ensure that all the loads are first powered off. Connect to an input power supply/wall outlet that is properly protected by a circuit breaker in accordance with national and local electrical codes. The input receptacle must be grounded.



Once the UPS is plugged into the wall outlet, it begins charging the battery.

Operation

1. Starting up the UPS

Plug the UPS input plug into a stable 230VAC source. The LCD display turns on and the batteries begin charging. Press and hold the ENTER/⏻ button for two seconds until the output turns On. The UPS is in Battery Self Test mode for 10 seconds. After a successful battery self test, the UPS is in On Mode.

2. Shutting down the UPS

Press and hold the ENTER/⏻ button for two seconds and use the popup window to confirm that the UPS should be turned Off. This will turn the outlets off. Disconnect the input power.

3. Fully shutting down the UPS

Perform the normal shutdown sequence. Remove the front bezel, then disconnect the battery connector. Replace the front bezel. The unit is now fully shut down.

Maintenance and Battery Replacement Precaution

Although the Vertiv™ Edge is designed and manufactured to ensure personal safety, improper use can result in electrical shock or fire. To ensure safety, observe the following precautions:

- Turn off and unplug the UPS before cleaning it.
- Clean the UPS with a dry cloth. Do not use liquid or aerosol cleaners.
- Never block or insert any objects into the UPS ventilation holes or openings.
- Do not place the UPS power cord where it might be damaged.

Battery Charging

The batteries are valve regulated, non spillable, lead acid and should be kept charged to attain their design life. The Vertiv™ Edge charges the batteries continuously when it is connected to the utility input power. If the Vertiv™ Edge will be stored for a long time, we recommend connecting the UPS to input power for at least 24 hours every four to six months to ensure full recharge of the batteries.

Replacing the Battery

IMPORTANT: Before you proceed, please review the battery safety precautions available at <https://www.vertiv.com/ComplianceRegulatoryInfo>.

You may safely replace the internal battery pack. See the Specifications in the User Guide online at www.Vertiv.com for the part number of the replacement battery for your UPS model number.

NOTE: Replace the battery with the same type and number as originally installed.

1. Removing the front panel

Remove the front bezel by pulling firmly until the snaps release.

2. Disconnecting the battery wires

Disconnect the battery connector by squeezing the ends and pulling apart.

3. Removing the battery box

Remove the two screws and the metal battery cover plate. Slide out the existing battery kit and disconnect the battery terminals from the connector, disconnecting the red wire first then the black wire.

4. Installing the new battery

Plug the removed connector into the terminals of the new battery, plugging the black wire in first then the red wire. Orient the connector and the new battery in the same way as the original battery, then slide them into the UPS. Reconnect the two halves of the battery connector and slide the front panel back on until it clicks. Replace the metal plate and secure with the two screws. Snap the front bezel back on.

5. Testing the new battery

Navigate through the menu to Settings > Battery > Replace Battery and confirm battery replacement.

6. Disposing of the old battery

Properly dispose of old batteries at an appropriate recycling center or return them to Vertiv in the packing material for the replacement batteries.

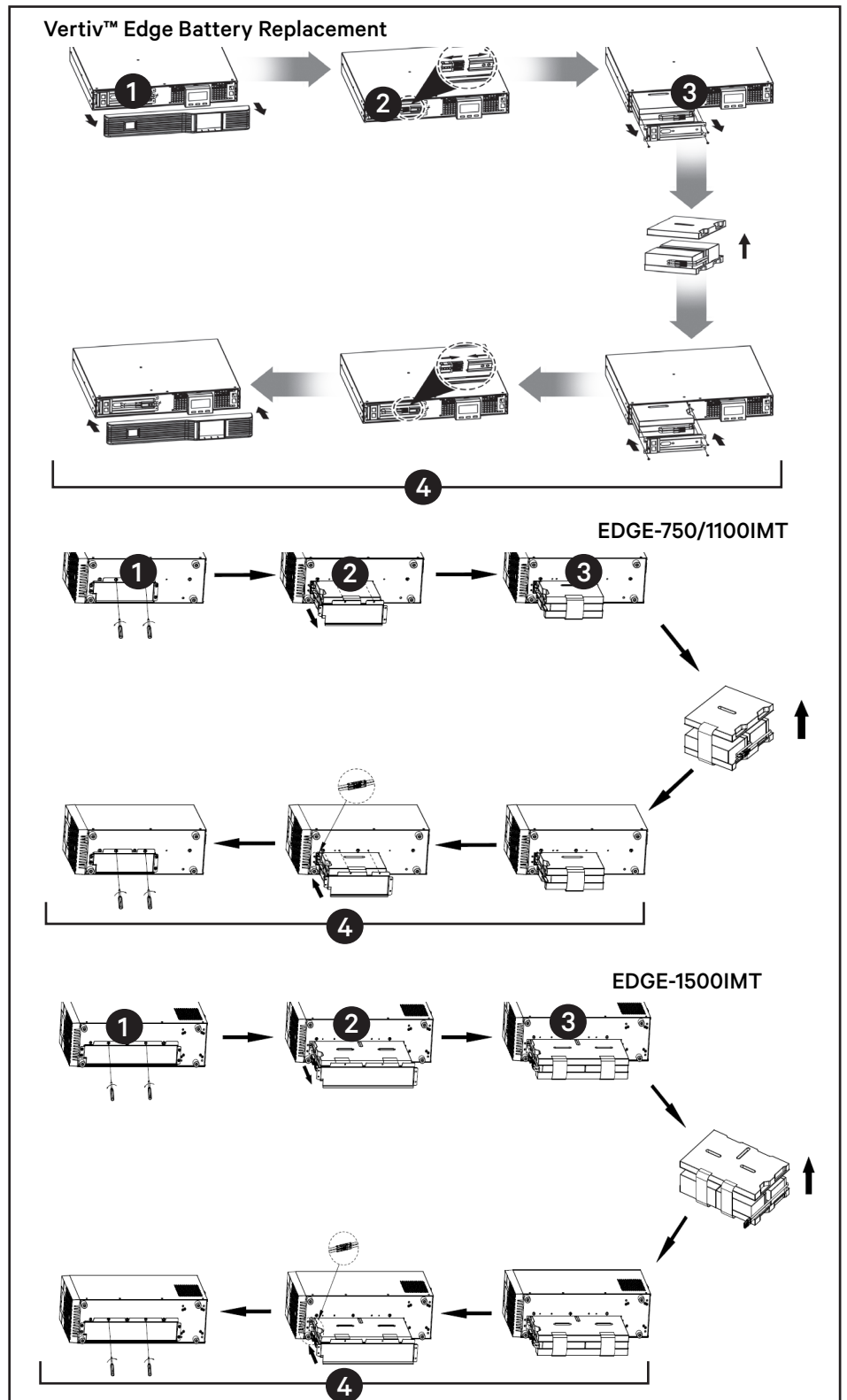

To contact Vertiv Technical Support: visit www.Vertiv.com

©2022 Vertiv Group Corp. All rights reserved. Vertiv™ and the Vertiv logo are trademarks or registered trademarks of Vertiv Group Corp. All other names and logos referred to are trade names, trademarks or registered trademarks of their respective owners. While every precaution has been taken to ensure accuracy and completeness here, Vertiv Group Corp. assumes no responsibility, and disclaims all liability, for damages resulting from use of this information or for any errors or omissions. Specifications, rebates and other promotional offers are subject to change at Vertiv's sole discretion upon notice.

